



US00D653467S

(12) **United States Design Patent**
Ballendat

(10) **Patent No.:** **US D653,467 S**

(45) **Date of Patent:** **** Feb. 7, 2012**

(54) **CHAIR**

(75) Inventor: **Martin Ballendat**, Braunau (AT)

(73) Assignee: **Dauphin Entwicklungs-u. Beteiligungs-GmbH**, Hersbruck (DE)

(**) Term: **14 Years**

(21) Appl. No.: **29/386,318**

(22) Filed: **Feb. 28, 2011**

(30) **Foreign Application Priority Data**

Oct. 25, 2010 (WO) 570 419 401

(51) **LOC (9) Cl.** **06-01**

(52) **U.S. Cl.** **D6/366**

(58) **Field of Classification Search** D6/334-336,
D6/364, 365, 366, 367, 374, 476, 379, 380,
D6/500-502; 297/300.1, 300.2, 411.27,
297/411.36, 452.21, 452.29, 452.3, 452.48

See application file for complete search history.

(56) **References Cited**

U.S. PATENT DOCUMENTS

D589,271 S * 3/2009 Neil D6/366
D595,970 S * 7/2009 Ueda D6/366

D607,653 S * 1/2010 Wilkinson et al. D6/366
D610,822 S * 3/2010 Chen D6/366
D611,276 S * 3/2010 Kubryk D6/366
D611,738 S * 3/2010 Kubryk D6/366
D618,927 S * 7/2010 Zhang D6/366
D638,230 S * 5/2011 Roy D6/366
D639,576 S * 6/2011 Breen D6/366
D640,478 S * 6/2011 Neil D6/366
D641,983 S * 7/2011 Hazzard D6/366

* cited by examiner

Primary Examiner — Brian N Vinson

(74) *Attorney, Agent, or Firm* — McGlew and Tuttle, P.C.

(57) **CLAIM**

The ornamental design for a chair, as shown and described.

DESCRIPTION

FIG. 1 is a front view of a chair, showing my new design;
FIG. 2 is a rear view thereof;
FIG. 3 is a top view thereof;
FIG. 4 is a bottom view thereof, the features shown in broken lines not forming a part of the claimed design;
FIG. 5 is a lateral view (right side) thereof;
FIG. 6 is a lateral view (left side) thereof; and,
FIG. 7 is a perspective view thereof.

1 Claim, 4 Drawing Sheets

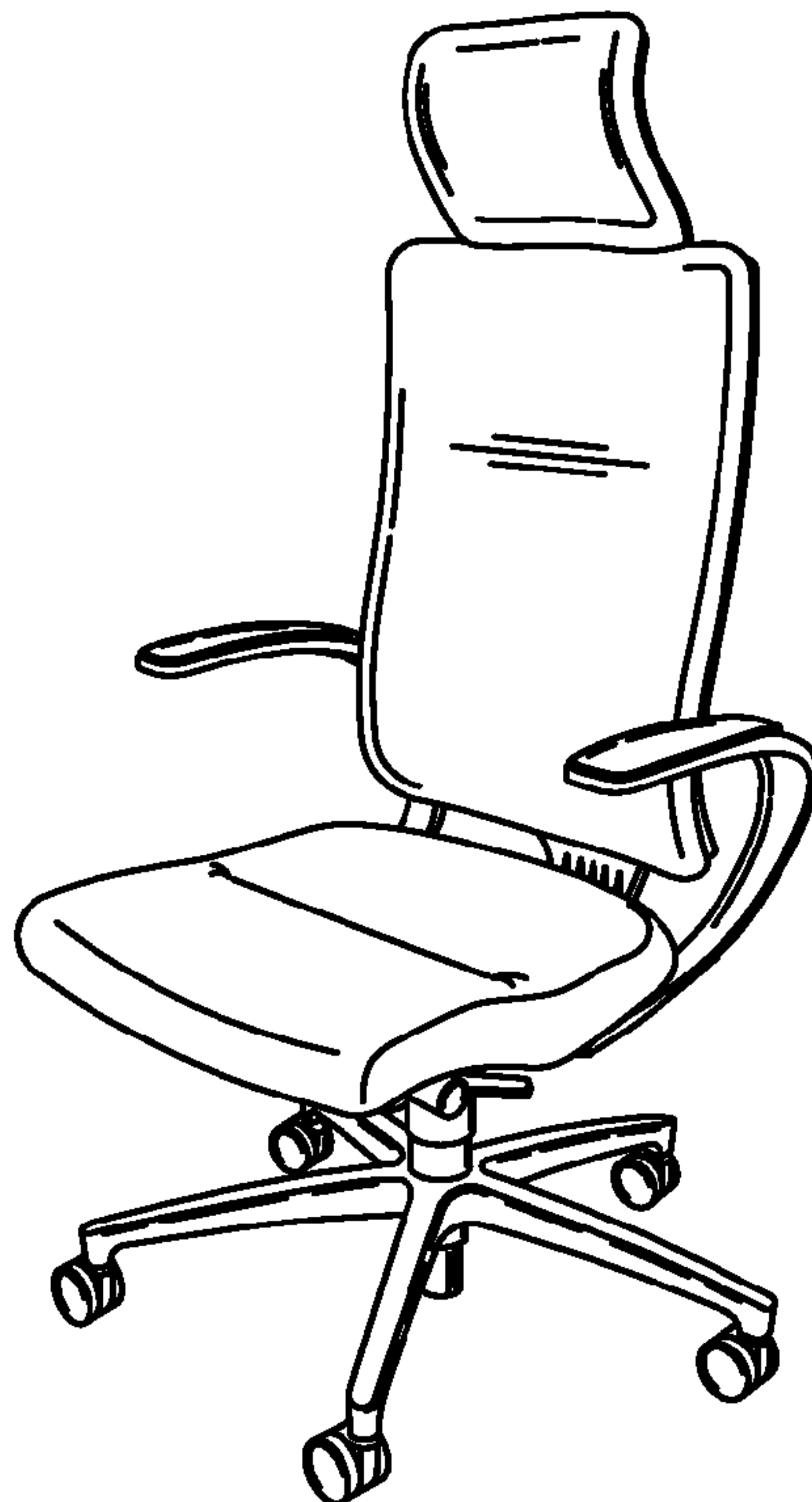

FIG. 1

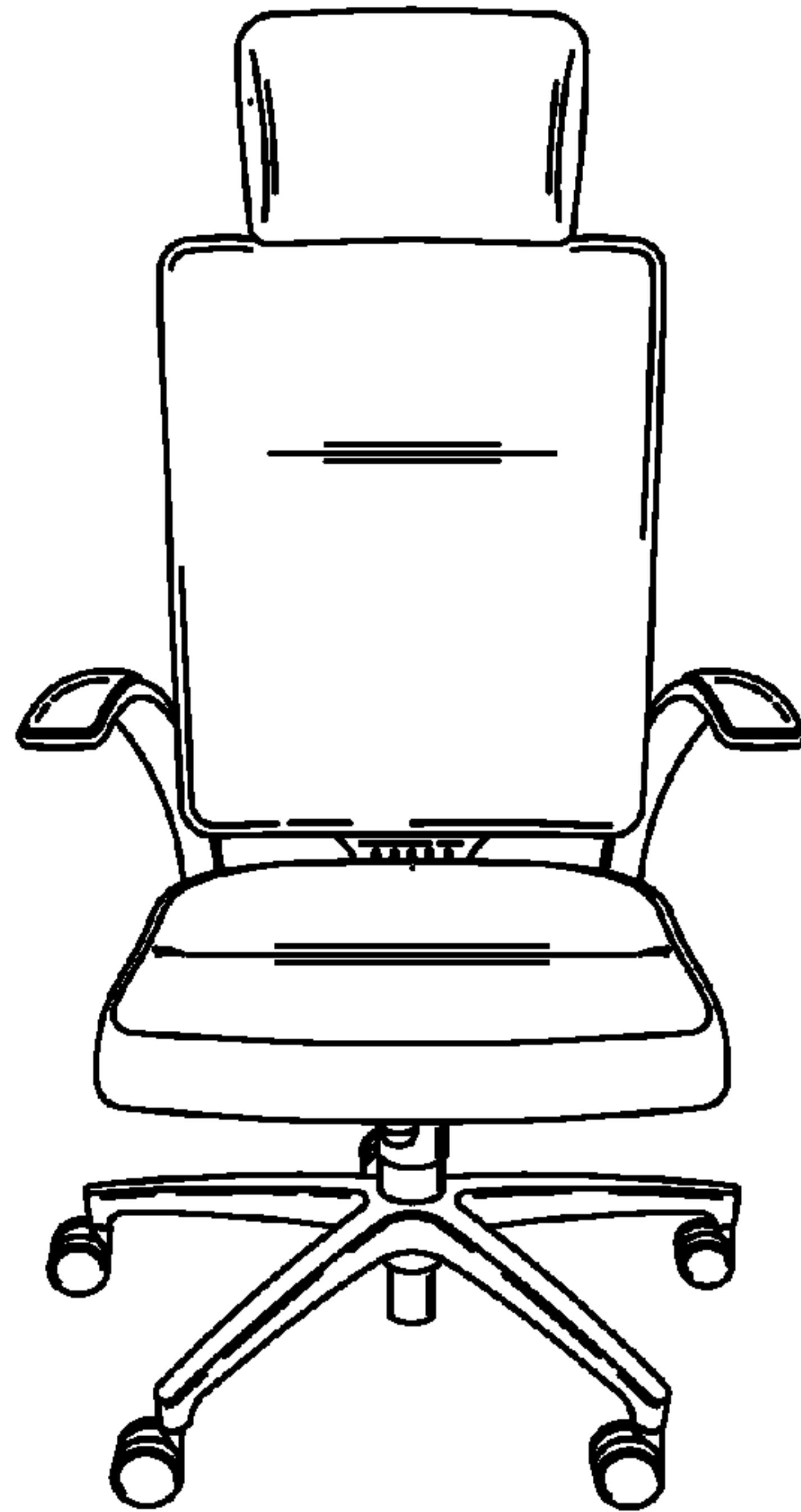

FIG. 2

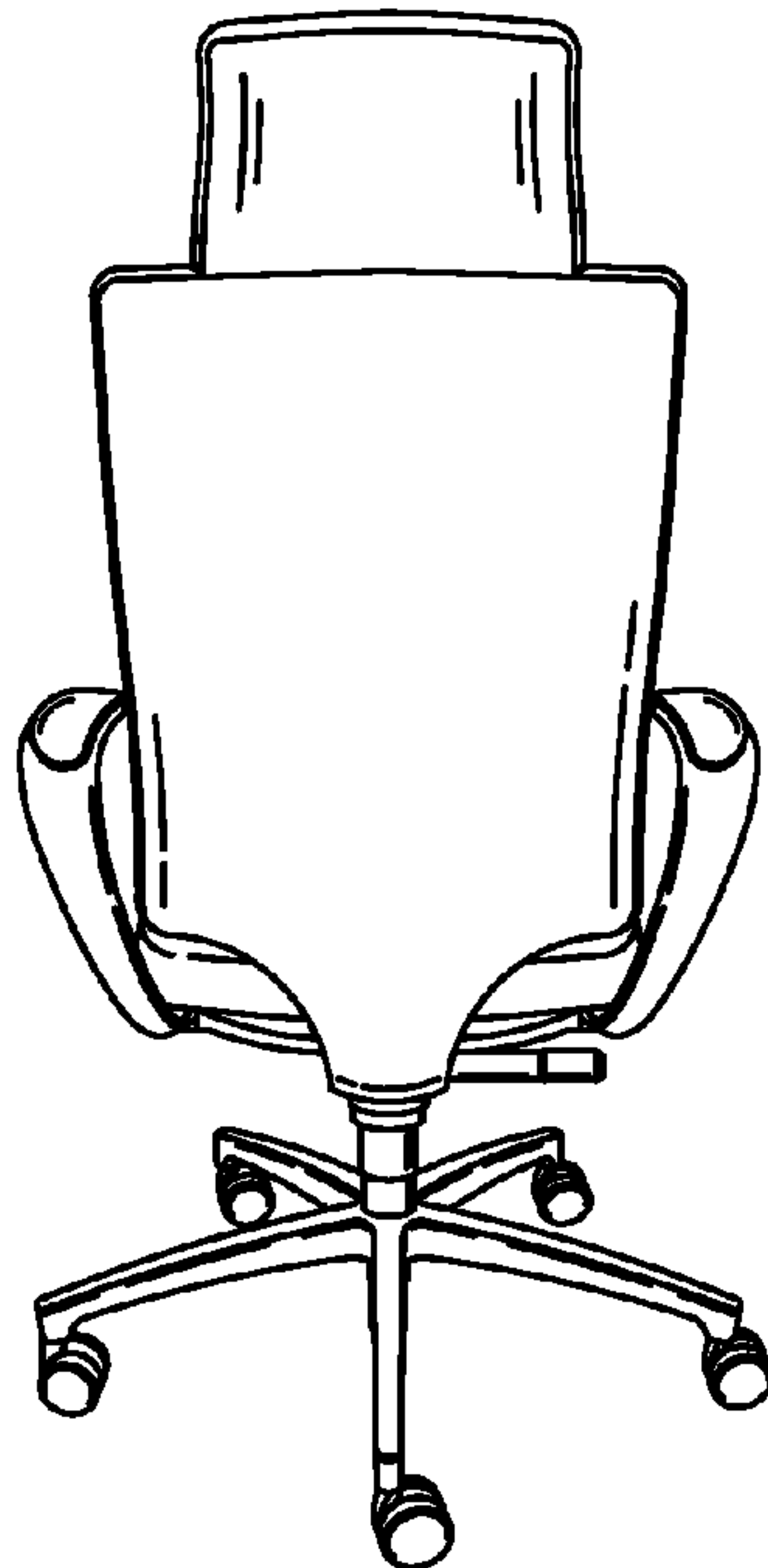

FIG. 3

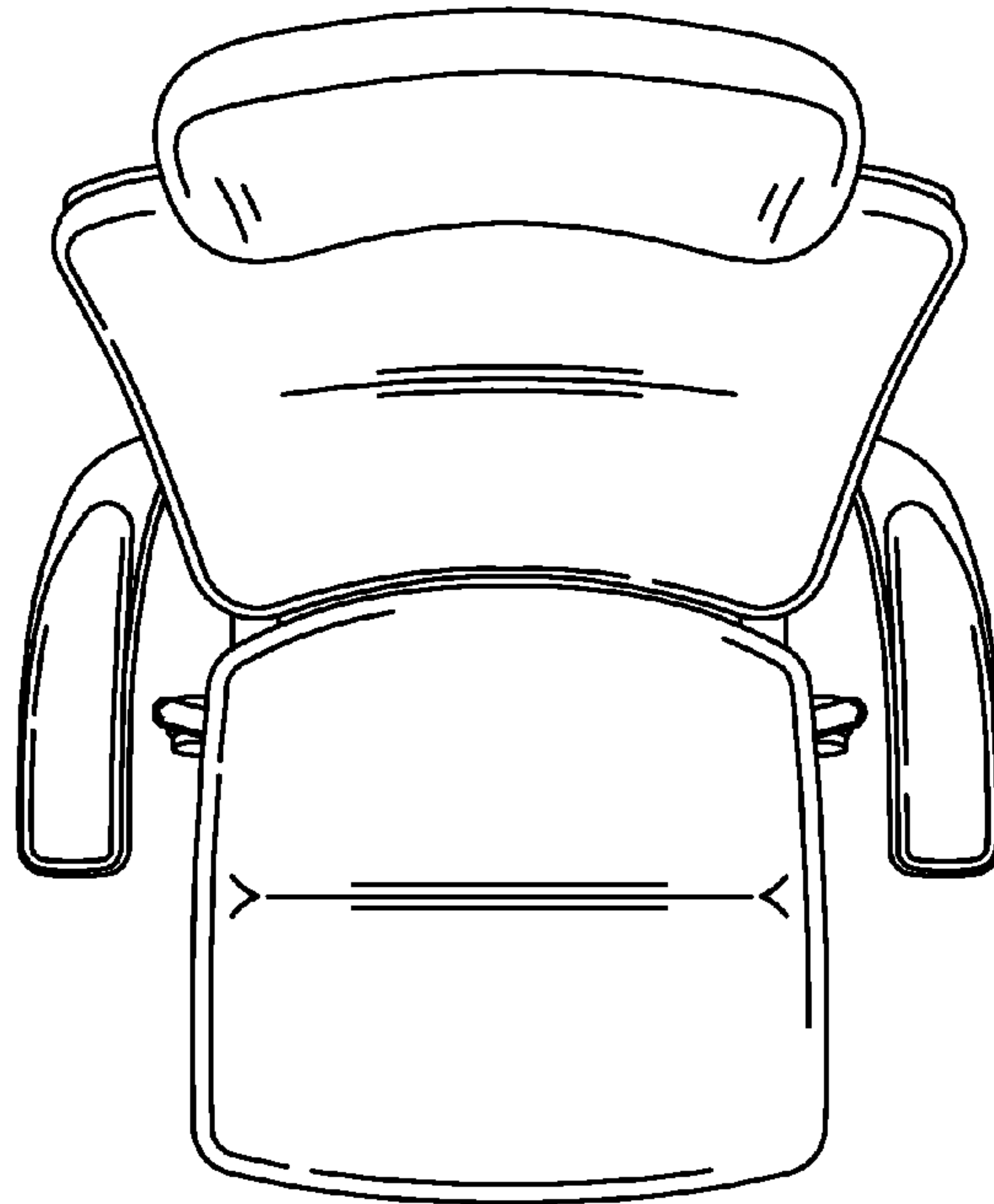

FIG. 4

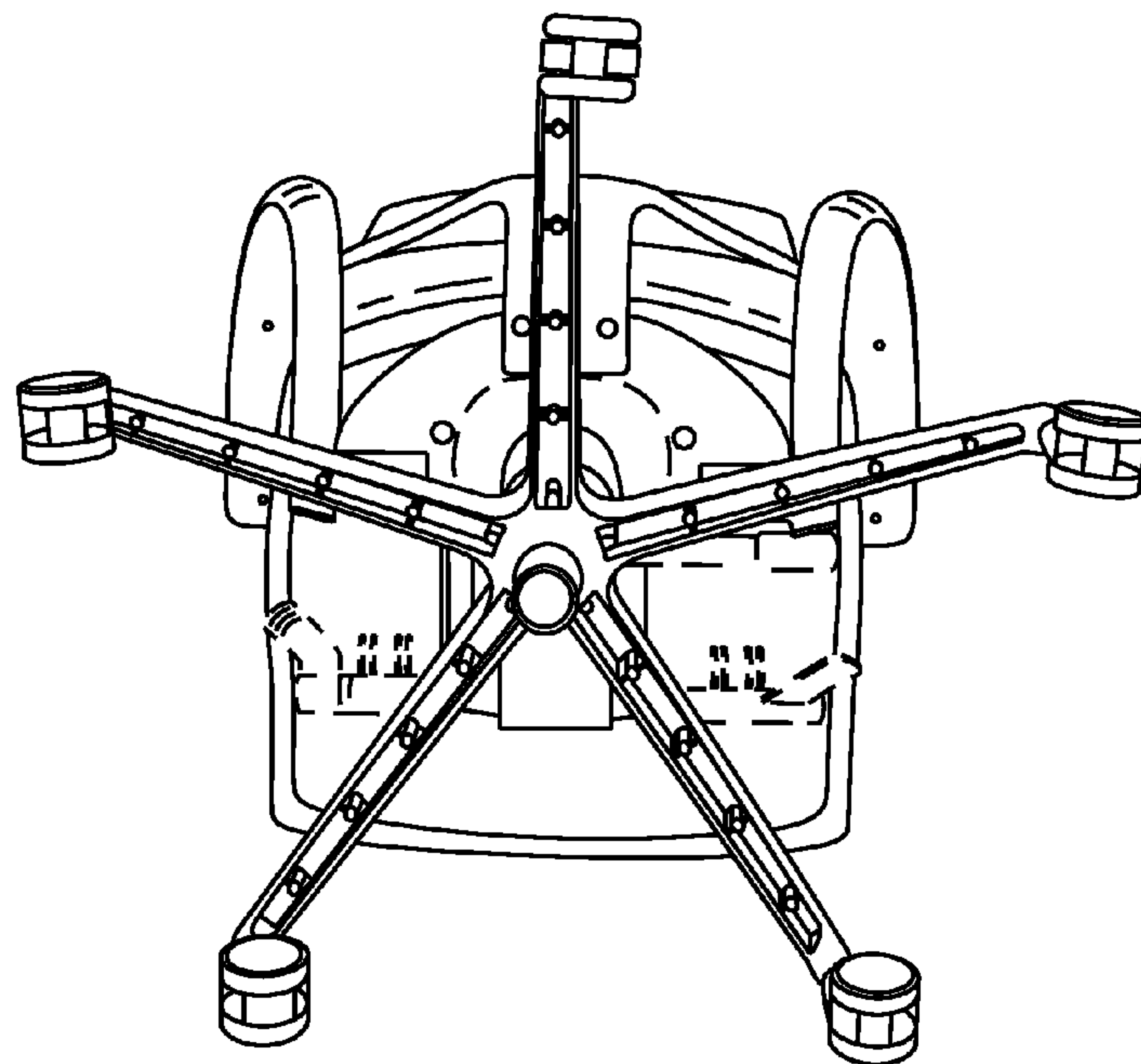

FIG. 5

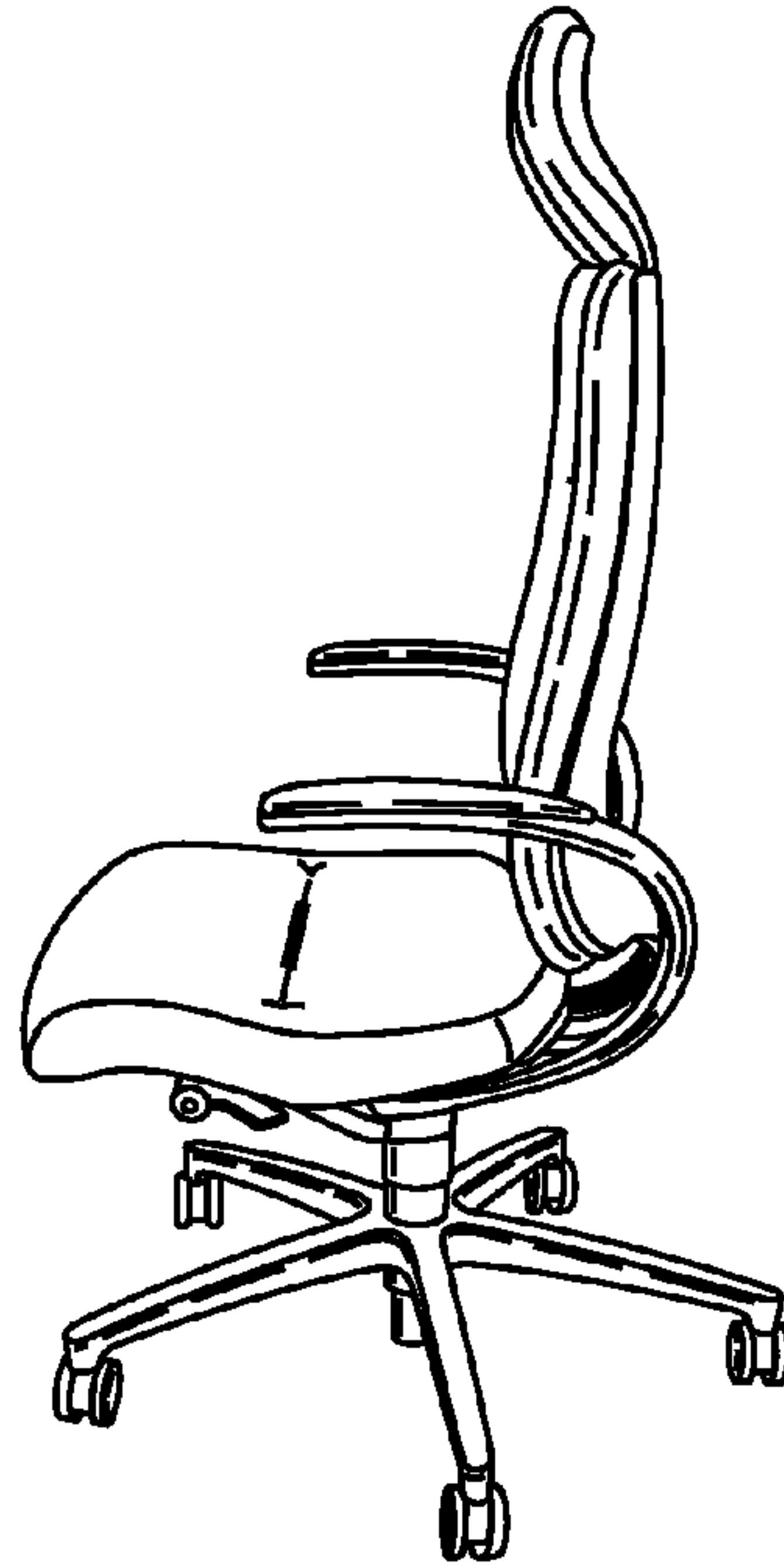

FIG. 6

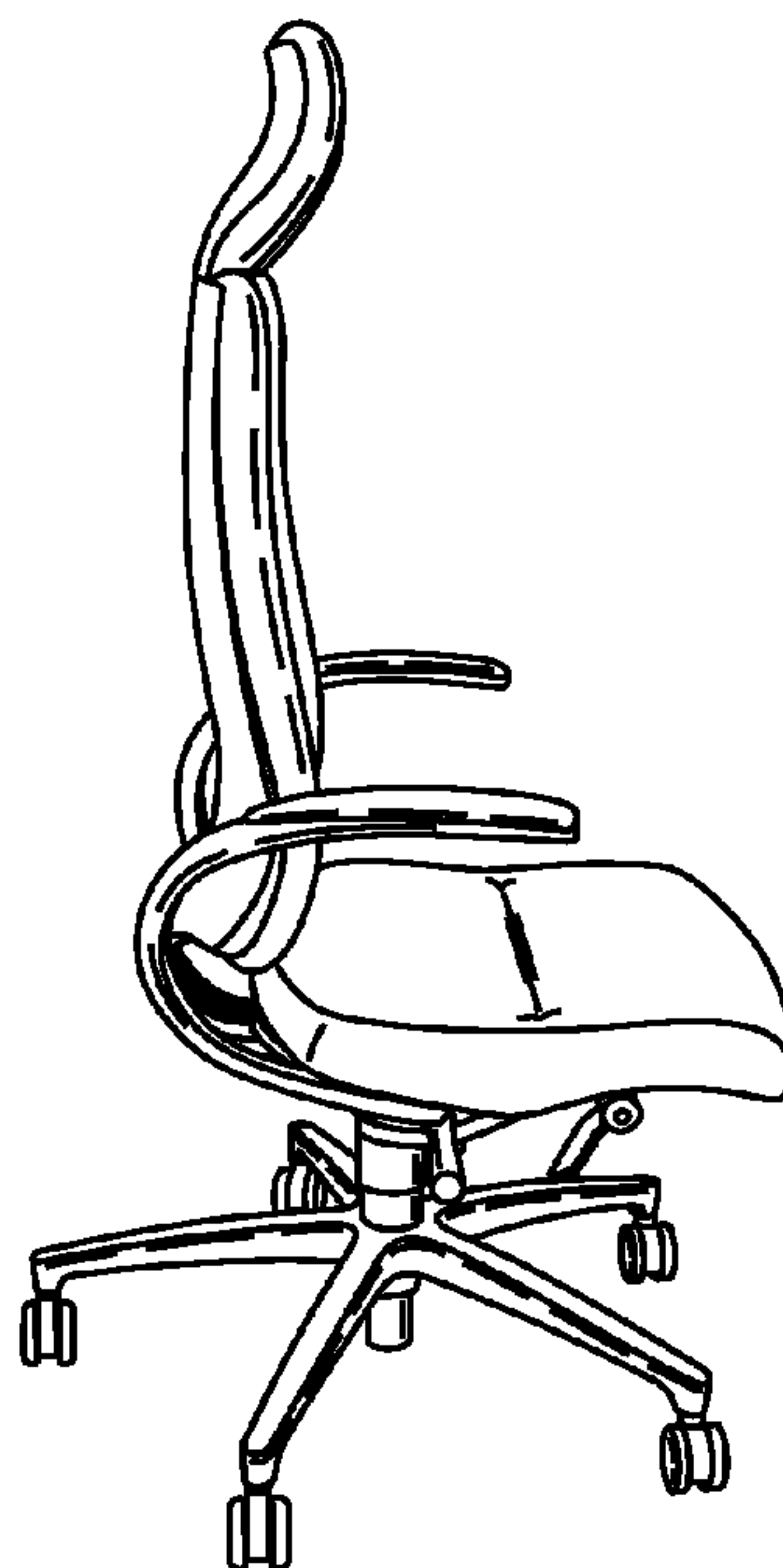

FIG. 7

