



US00D653402S

(12) **United States Design Patent**  
**Shamoon**

(10) **Patent No.:** **US D653,402 S**  
(45) **Date of Patent:** **\*\* Jan. 31, 2012**

(54) **HEAT-RESISTANT KITCHENWARE TOOL**

(76) Inventor: **Ellis N. Shamoon**, Dallas, TX (US)

(\*\*) Term: **14 Years**

(21) Appl. No.: **29/386,873**

(22) Filed: **Mar. 4, 2011**

(51) **LOC (9) Cl.** ..... **02-06**

(52) **U.S. Cl.** ..... **D29/119**

(58) **Field of Classification Search** ..... D2/610,  
D2/611, 612, 613, 615, 616, 617, 618, 619,  
D2/620, 621, 623; D7/388; D20/33; D21/807;  
D24/212; D28/63; D29/113, 114, 116.2,  
D29/116.3, 117.1, 117.2, 118, 119, 120.1,  
D29/123; 2/16, 20, 21, 158, 159, 160, 161.1,  
2/161.2, 161.3, 161.4, 161.5, 161.6, 161.7,  
2/161.8, 162, 163, 168, 169, 170, 455, 908,  
2/910, 917; 15/227; 40/586

See application file for complete search history.

(56) **References Cited**

**U.S. PATENT DOCUMENTS**

114,331	A *	5/1871	O'Hara	.....	30/121.5
348,782	A *	9/1886	Sawyer	.....	52/177
580,148	A *	4/1897	Staples	.....	38/95
1,990,553	A *	2/1935	Hirsch et al.	.....	2/20
2,157,543	A *	5/1939	Kingman	.....	401/183
2,664,812	A *	1/1954	Molina	.....	249/120
D188,383	S *	7/1960	Gravning	.....	D22/149
D194,255	S *	12/1962	Altmeyer et al.	.....	D24/212
3,407,927	A *	10/1968	Jones	.....	206/372
4,682,803	A *	7/1987	Andrews	.....	452/196
D336,198	S *	6/1993	Gibbons	.....	D6/583
D388,553	S *	12/1997	Sapin	.....	D29/119
D389,282	S *	1/1998	Dyke et al.	.....	D29/113
5,829,061	A *	11/1998	Visgil et al.	.....	2/161.6
6,014,779	A *	1/2000	Lindholm	.....	4/583

D475,792	S *	6/2003	Robbins, III	.....	D24/212
D504,544	S *	4/2005	Lee	.....	D29/118
D506,292	S *	6/2005	Root et al.	.....	D29/119
D519,684	S *	4/2006	Simic	.....	D29/118
D526,096	S *	8/2006	Kaposi	.....	D29/118
7,124,446	B2 *	10/2006	Demay et al.	.....	2/16
7,165,270	B2 *	1/2007	DeYoung et al.	.....	2/16
7,234,170	B2 *	6/2007	Simic	.....	2/16
D547,010	S *	7/2007	Shamoon	.....	D29/118
D575,460	S *	8/2008	Patel	.....	D29/118
D580,215	S *	11/2008	McCarthy et al.	.....	D7/368
D581,726	S	12/2008	Shamoon		
D617,551	S *	6/2010	Siekman et al.	.....	D3/226
7,740,645	B2 *	6/2010	Babaev	.....	606/204
7,788,737	B2 *	9/2010	Baker et al.	.....	2/161.6
D634,898	S *	3/2011	Lion et al.	.....	D29/119
D645,311	S *	9/2011	Shamoon	.....	D7/698
2005/0160512	A1 *	7/2005	DeYoung et al.	.....	2/21

**FOREIGN PATENT DOCUMENTS**

EM 000156708-0002 \* 6/2004

\* cited by examiner

*Primary Examiner* — Karen E Eldridge Powers

(74) *Attorney, Agent, or Firm* — Daniel V. Thompson

(57) **CLAIM**

The ornamental design for a heat-resistant kitchenware tool, as shown and described.

**DESCRIPTION**

FIG. 1 is a front-facing perspective view of the heat-resistant kitchenware tool showing my new design; FIG. 2 is a top plan view thereof; FIG. 3 is a bottom plan view thereof; FIG. 4 is a left-side elevational view thereof; FIG. 5 is a right-side elevational view thereof; FIG. 6 is a front-side elevational view thereof; and, FIG. 7 is a back-side elevational view thereof.

**1 Claim, 6 Drawing Sheets**

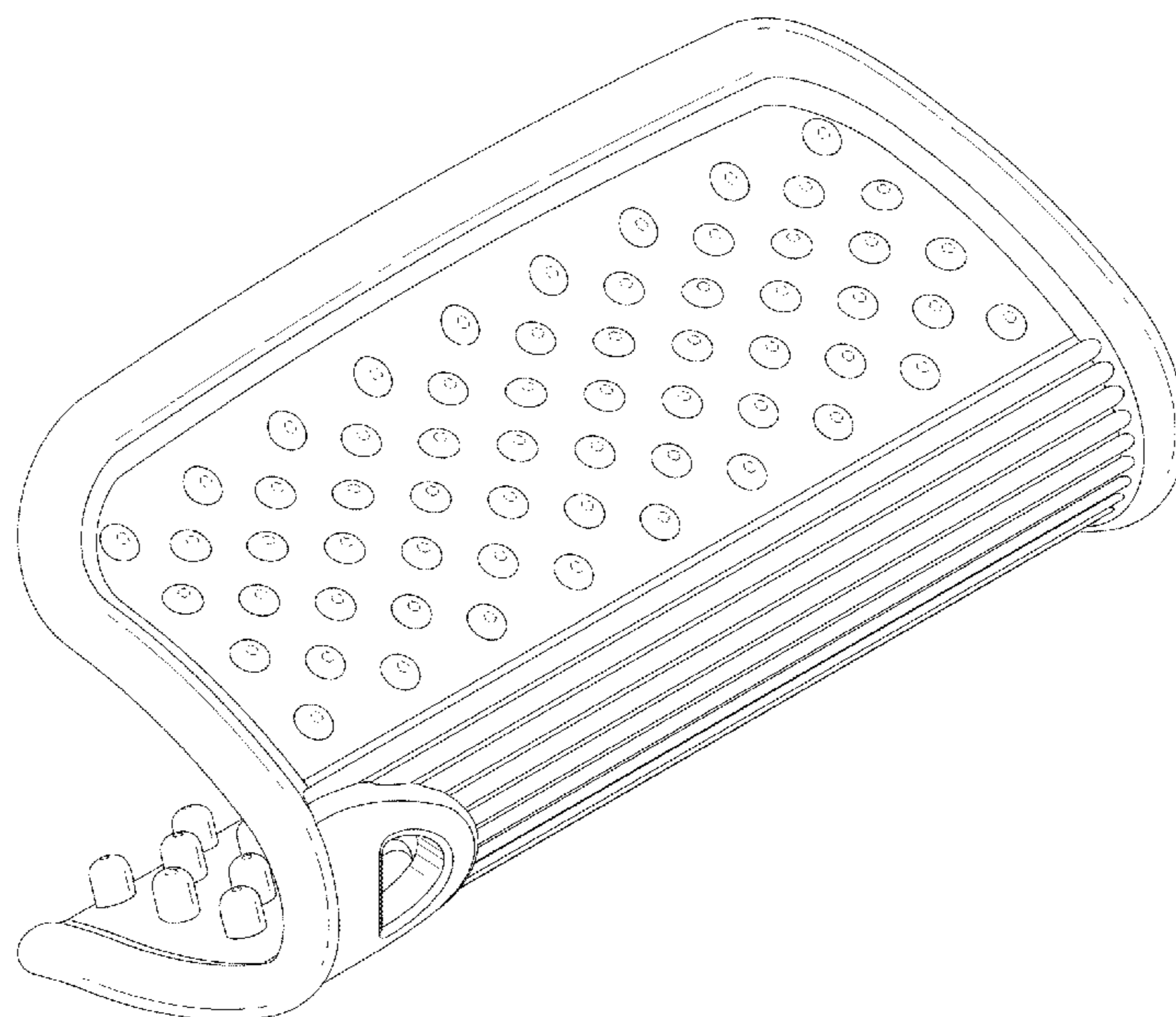

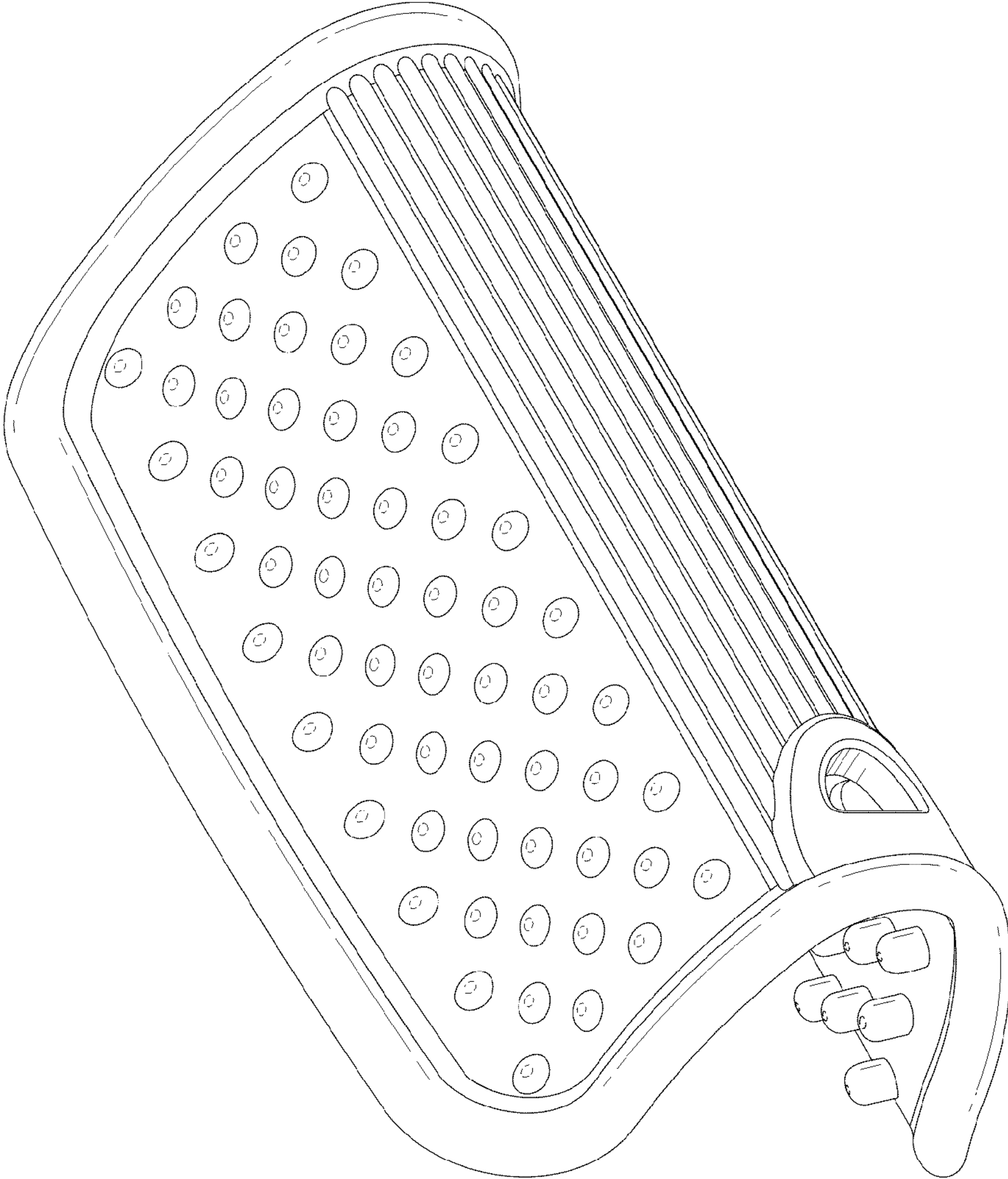

Fig. 1

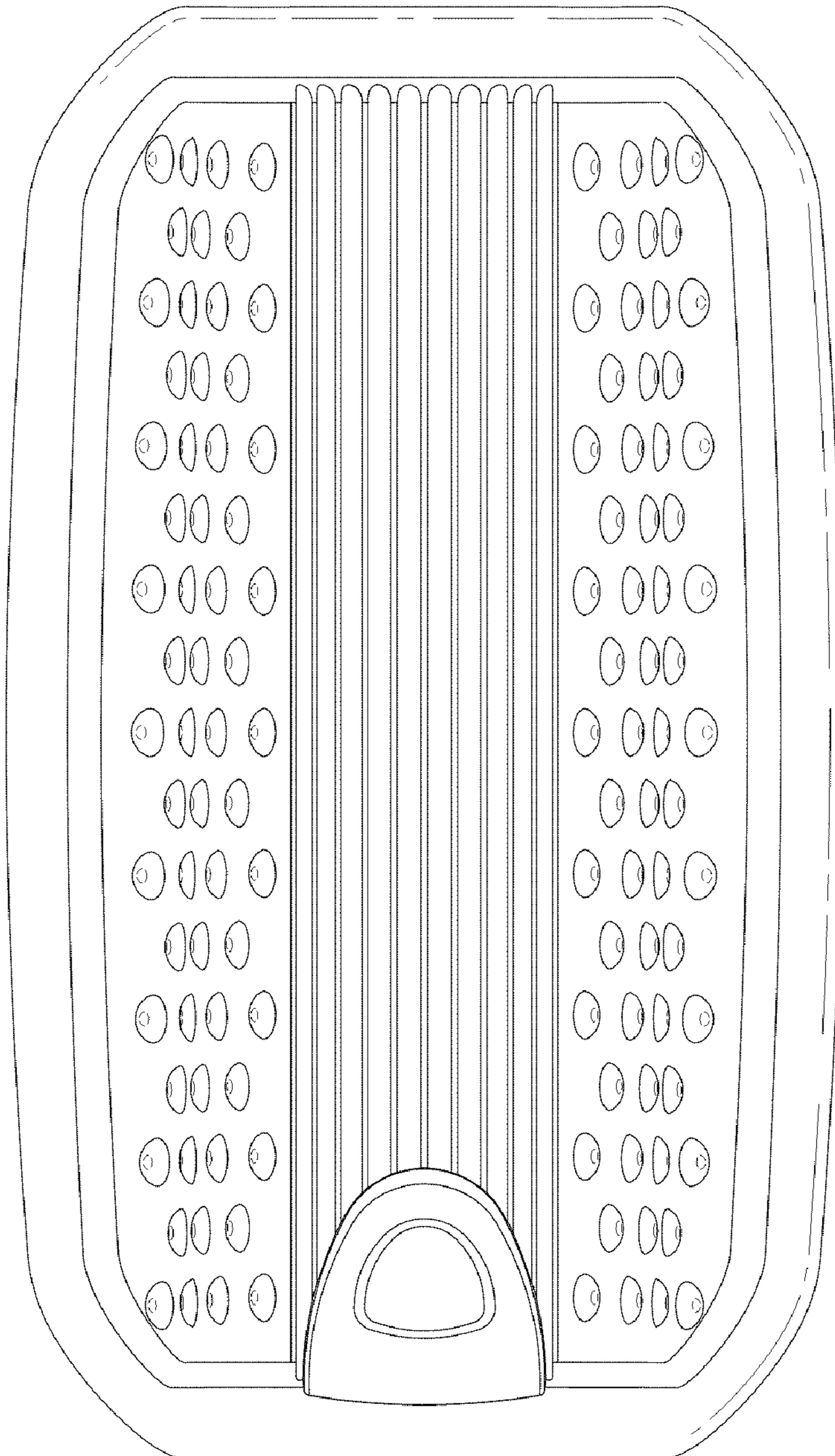

Fig. 2

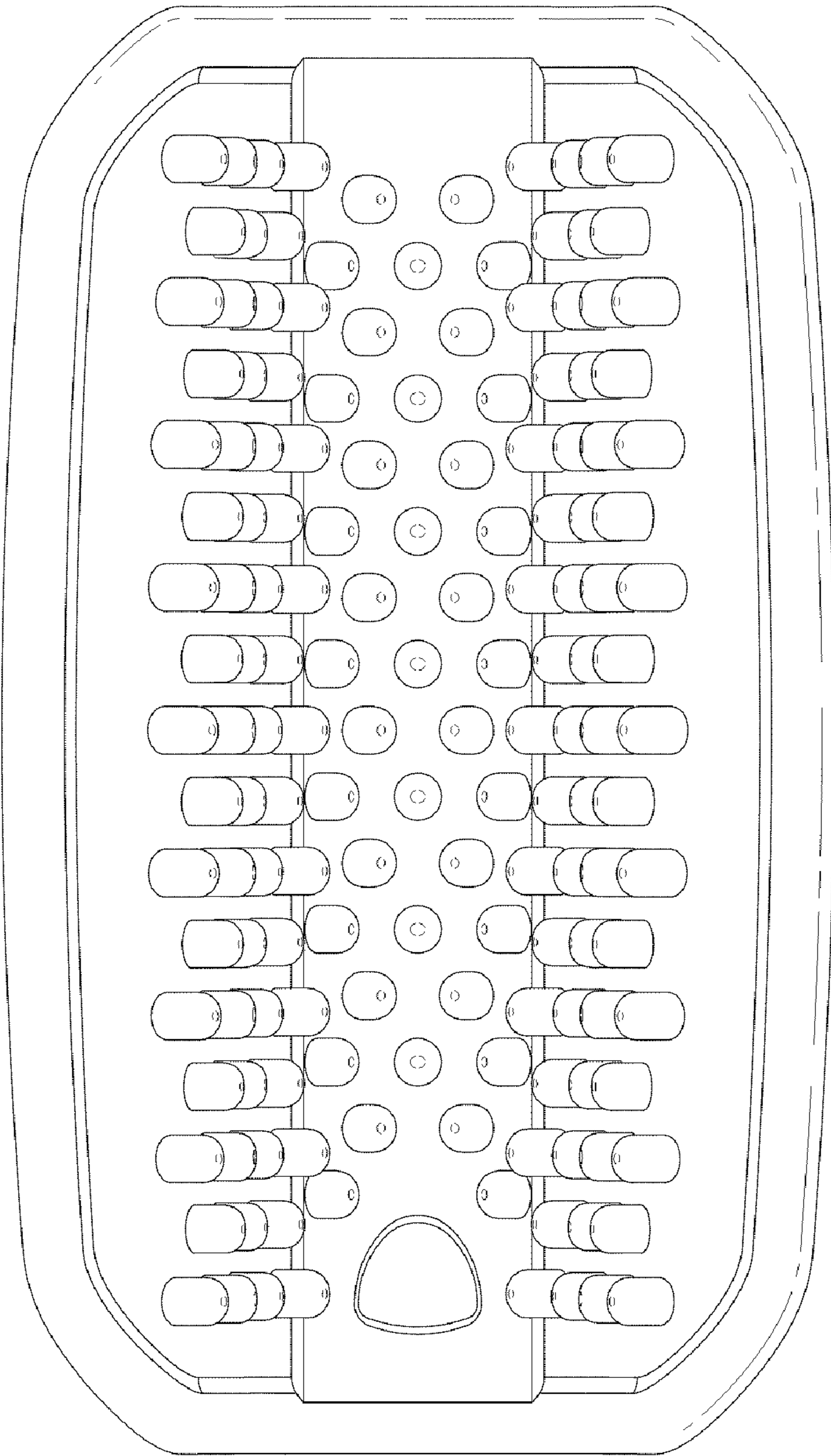

Fig. 3

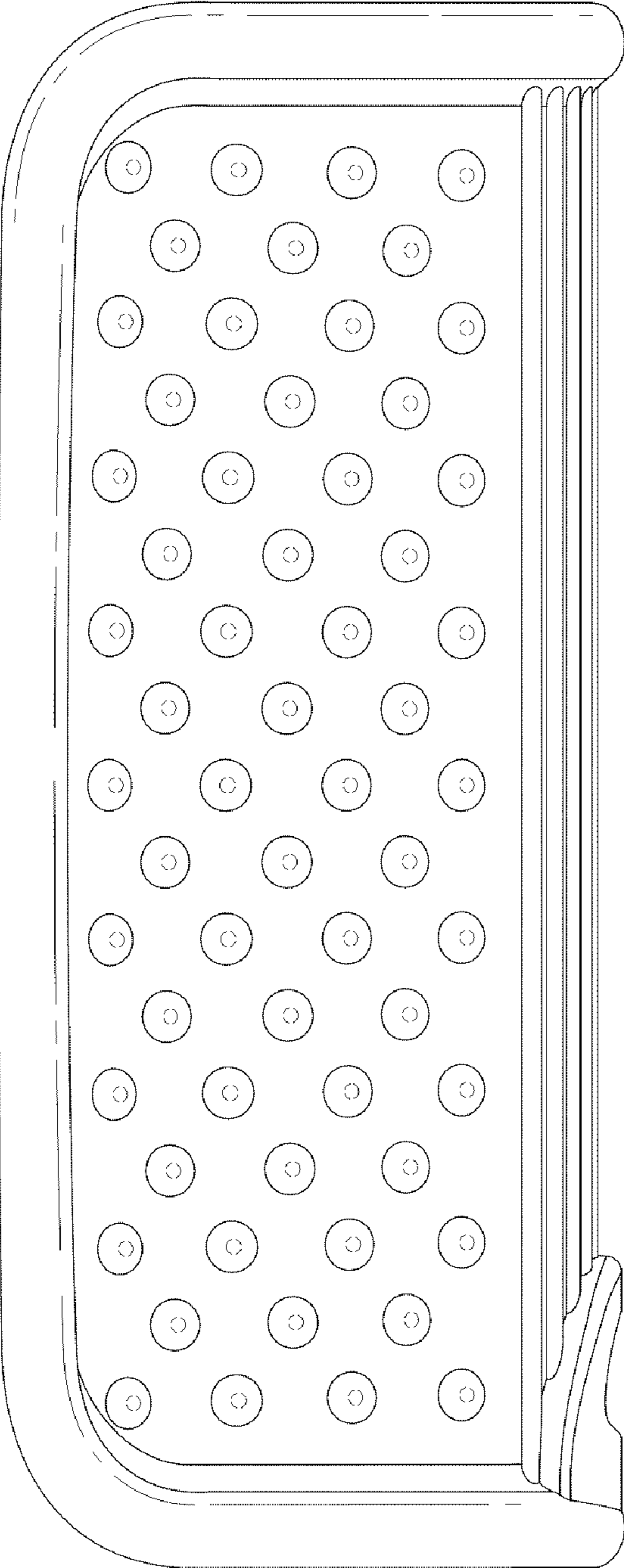

Fig. 4

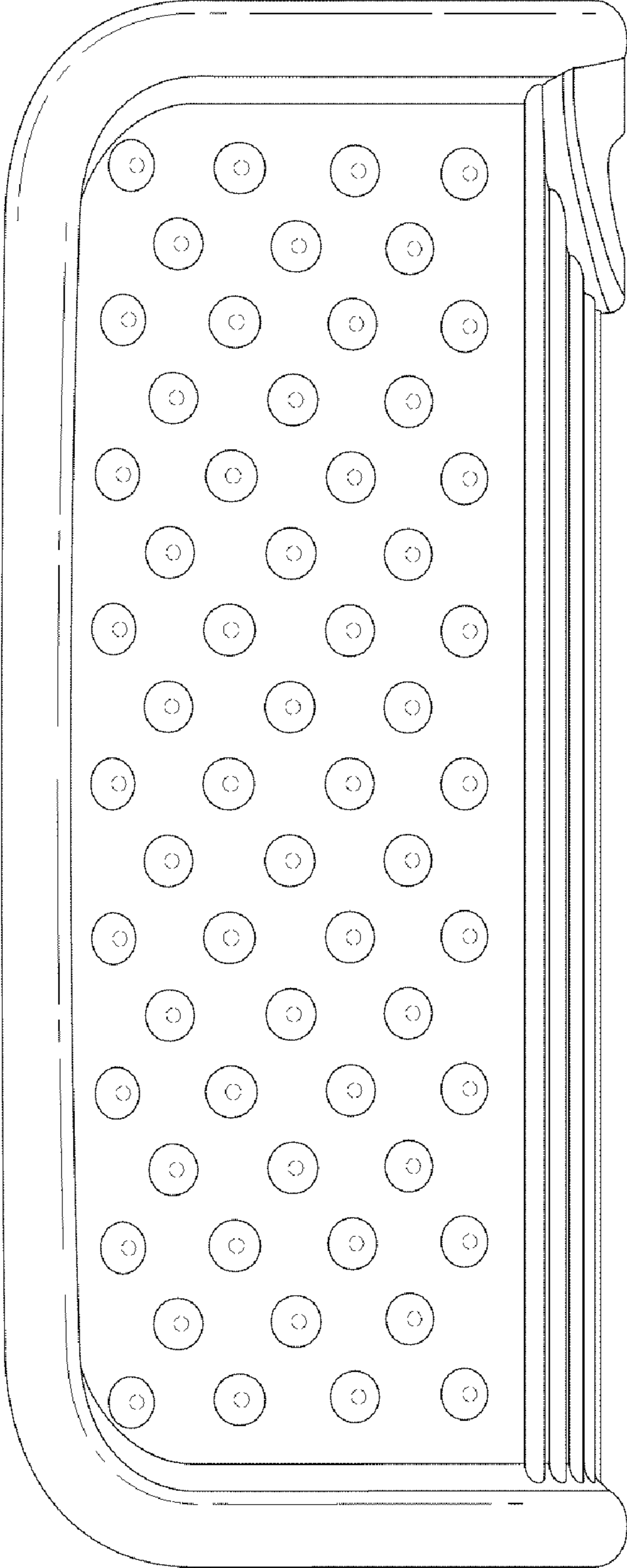

Fig. 5

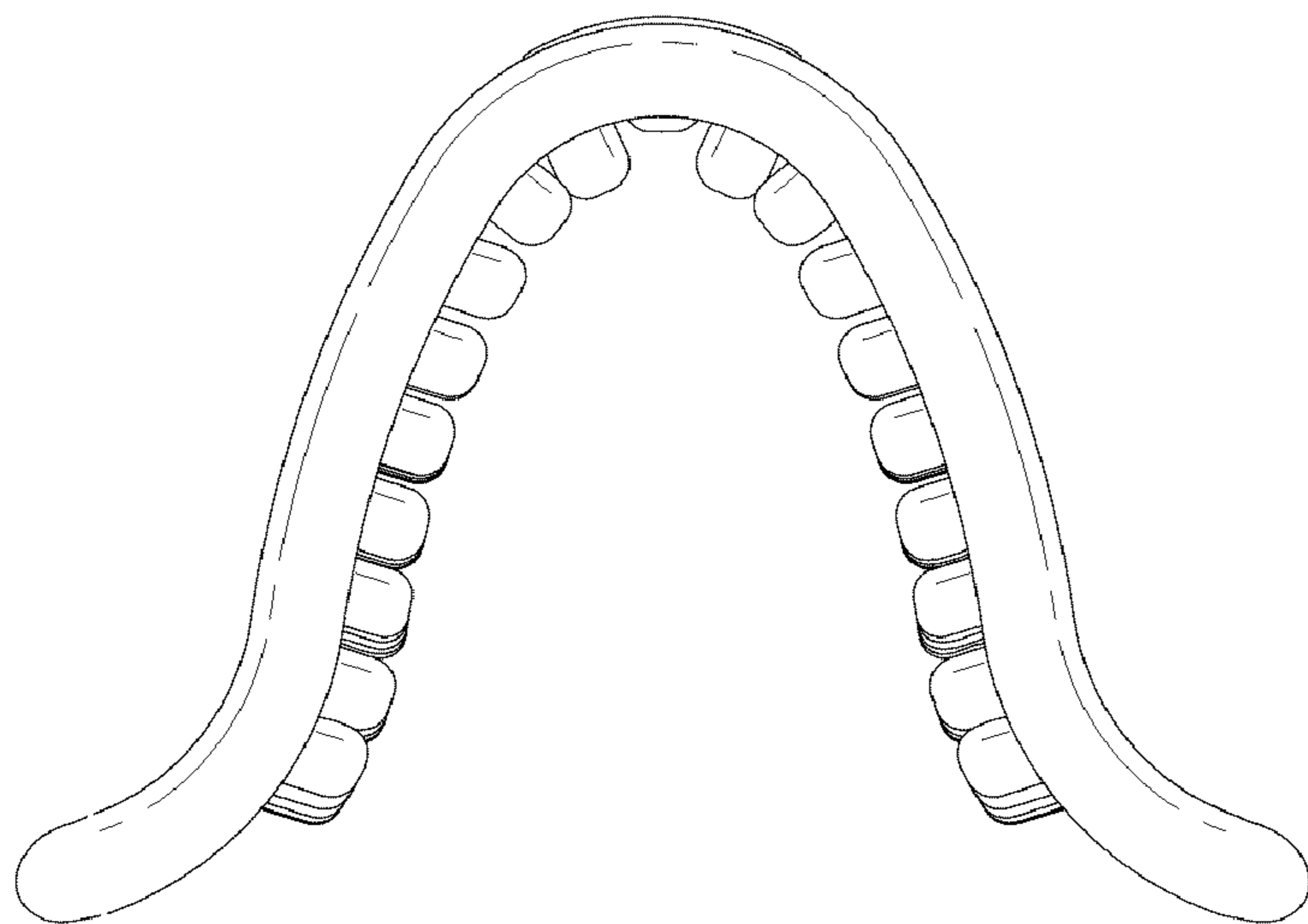

Fig. 7

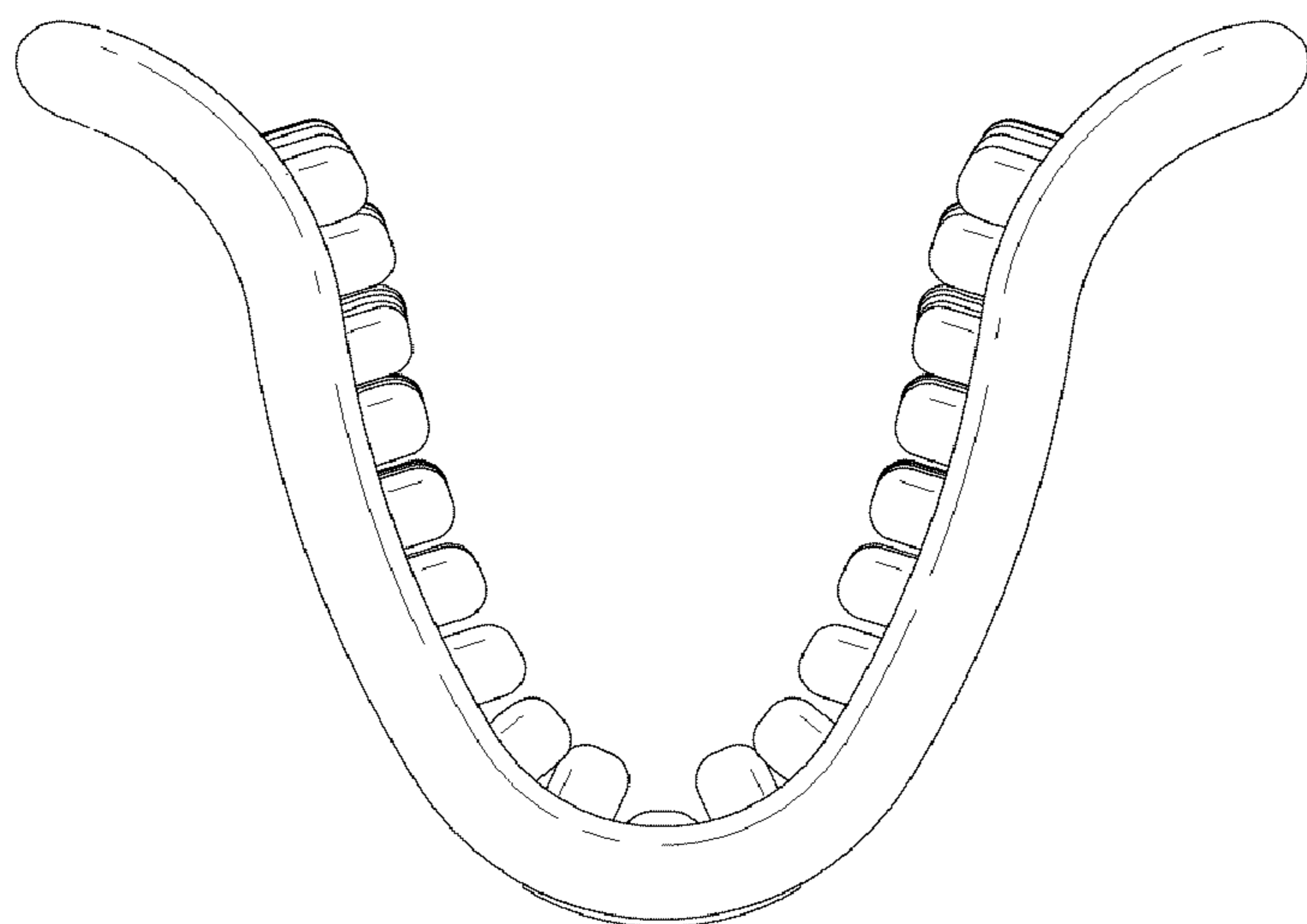

Fig. 6