

US00D653361S

(12) **United States Design Patent**
Hudson et al.

(10) **Patent No.:** **US D653,361 S**
(45) **Date of Patent:** **** Jan. 31, 2012**

(54) **SHAKE ROOF PANEL**

(75) Inventors: **Willard C. Hudson**, Southlake, TX (US); **James F. Sauter**, Arlington, TX (US); **Kevin B. Pelka**, Lake Elsinore, CA (US); **Geoffrey S. Allan**, Arlington, TX (US); **Peter B. Richards**, Auckland (NZ); **David R. Painter**, North Shore Auckland (NZ)

(73) Assignee: **Decra Roofing Systems, Inc.**, Arlington, TX (US)

(**) Term: **14 Years**

(21) Appl. No.: **29/397,298**

(22) Filed: **Jul. 14, 2011**

Related U.S. Application Data

(62) Division of application No. 29/379,310, filed on Nov. 17, 2010, now Pat. No. Des. 644,754.

(51) **LOC (9) Cl.** **25-01**

(52) **U.S. Cl.** **D25/140; D25/139**

(58) **Field of Classification Search** D25/140, D25/139; 52/519, 526, 518, 536, 539, 541, 52/544; 126/621, 622, 623
See application file for complete search history.

(56) **References Cited**

U.S. PATENT DOCUMENTS

0,734,976 A 7/1903 Simmerman
D165,977 S * 2/1952 Haman et al. D25/123
3,114,218 A 12/1963 Macquere

4,204,520 A 5/1980 Rosenberg
4,244,355 A 1/1981 Stout
4,606,164 A 8/1986 Mendez
4,731,969 A 3/1988 Baker et al.
D331,812 S 12/1992 Bunger
6,564,523 B1 5/2003 Iole et al.
D478,179 S 8/2003 Fifield
7,845,141 B2 12/2010 Martinique
2006/0059836 A1* 3/2006 Monsieur 52/588.1
2009/0223550 A1 9/2009 Curtin et al.

* cited by examiner

Primary Examiner — Doris Clark

(74) *Attorney, Agent, or Firm* — Baker & McKenzie LLP

(57) **CLAIM**

The ornamental design for a shake roof panel, as shown and described.

DESCRIPTION

FIG. 1 is a perspective view of a shake roof panel in accordance with our design;

FIG. 2 is another perspective view of the shake roof panel in accordance with the embodiment of our design;

FIG. 3 is a top plan view of the shake roof panel in accordance with the embodiment of our design;

FIG. 4 is a front elevation view of the shake roof panel in accordance with the embodiment of our design;

FIG. 5 is a side elevation view of the shake roof panel in accordance with the embodiment of our design, the opposite side being a mirror image;

FIG. 6 is a back elevation view of the shake roof panel in accordance with the embodiment of our design; and,

FIG. 7 is a bottom plan view of the shake roof panel in accordance with the embodiment of our design.

1 Claim, 4 Drawing Sheets

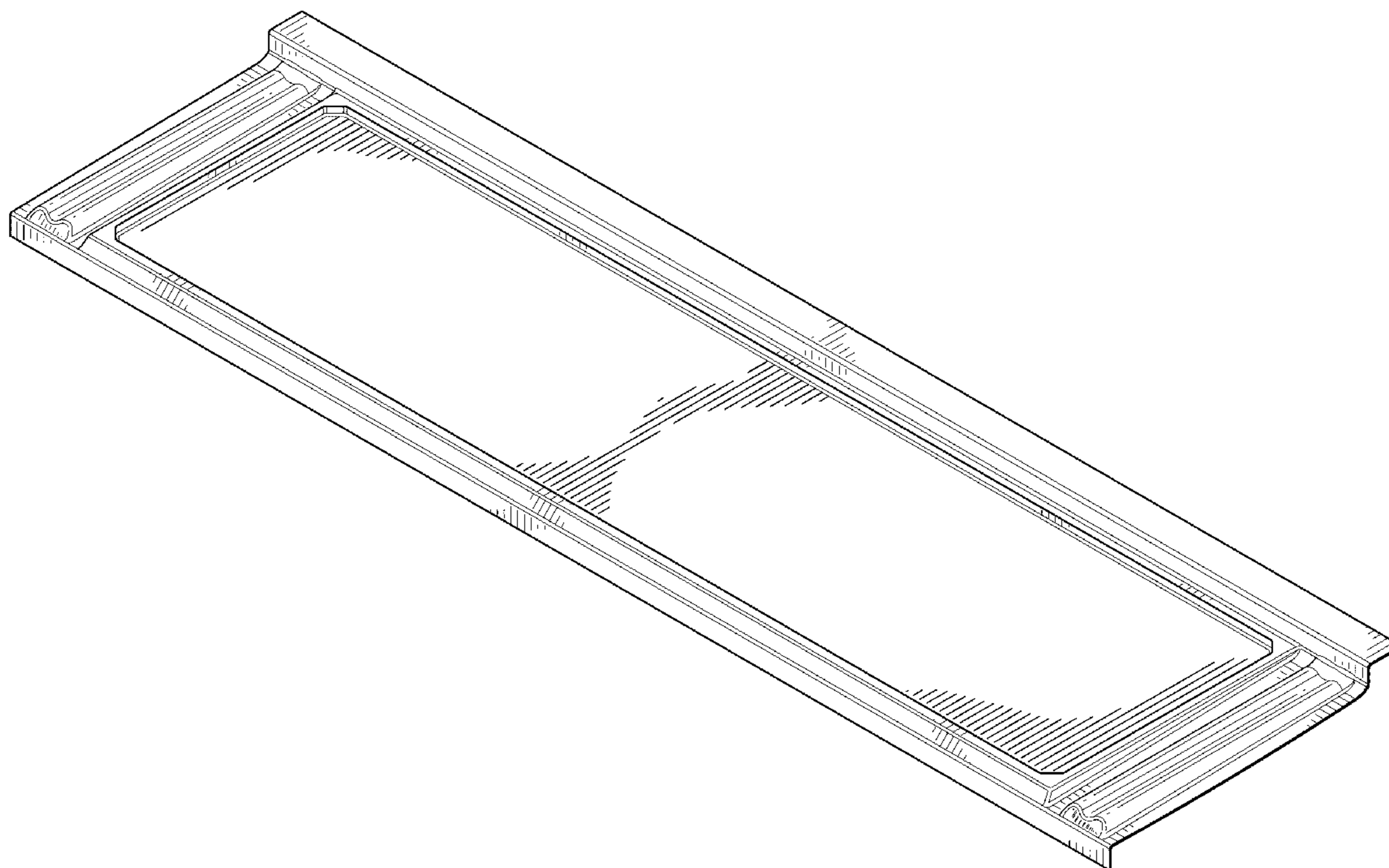

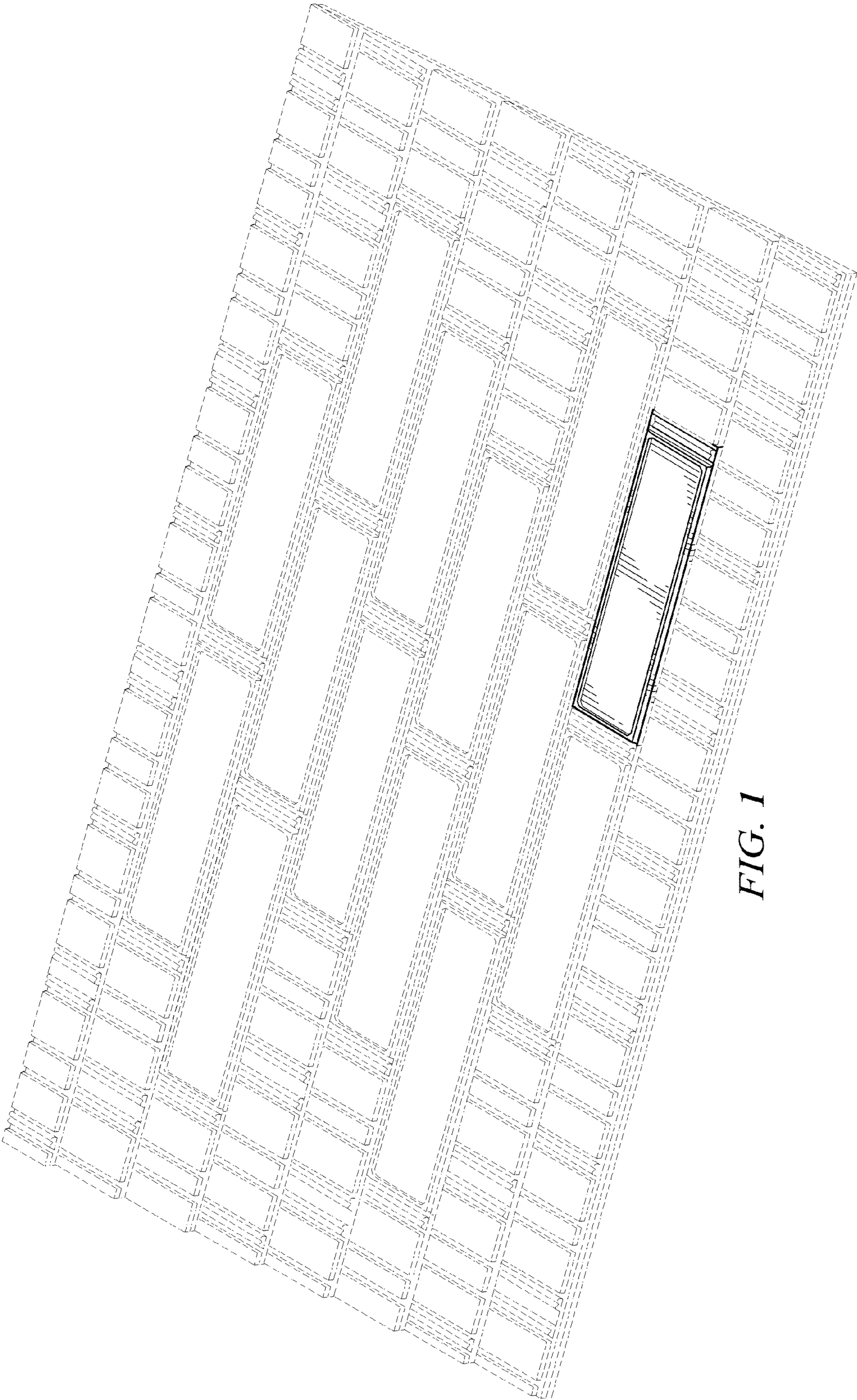

FIG. 1

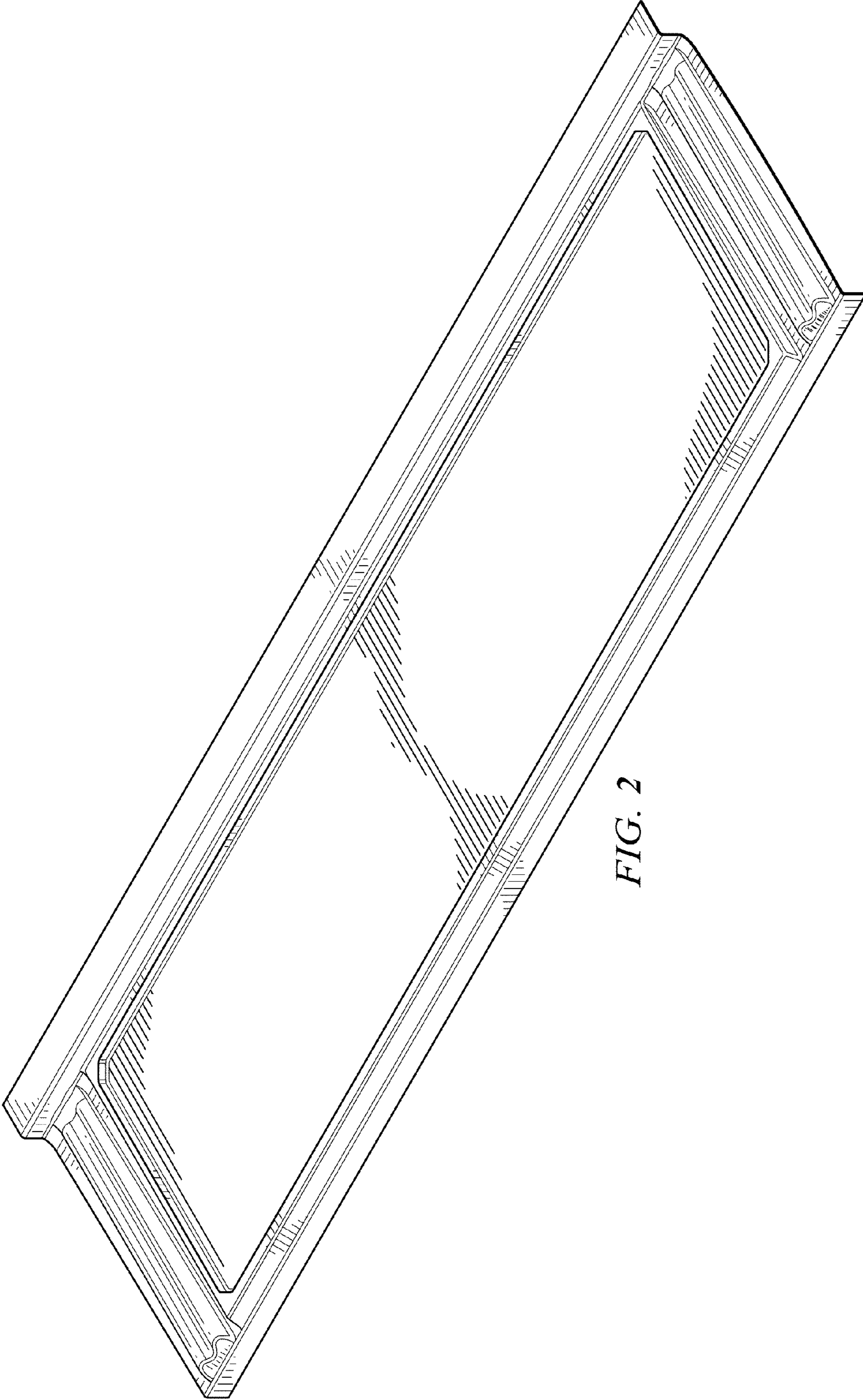

FIG. 2

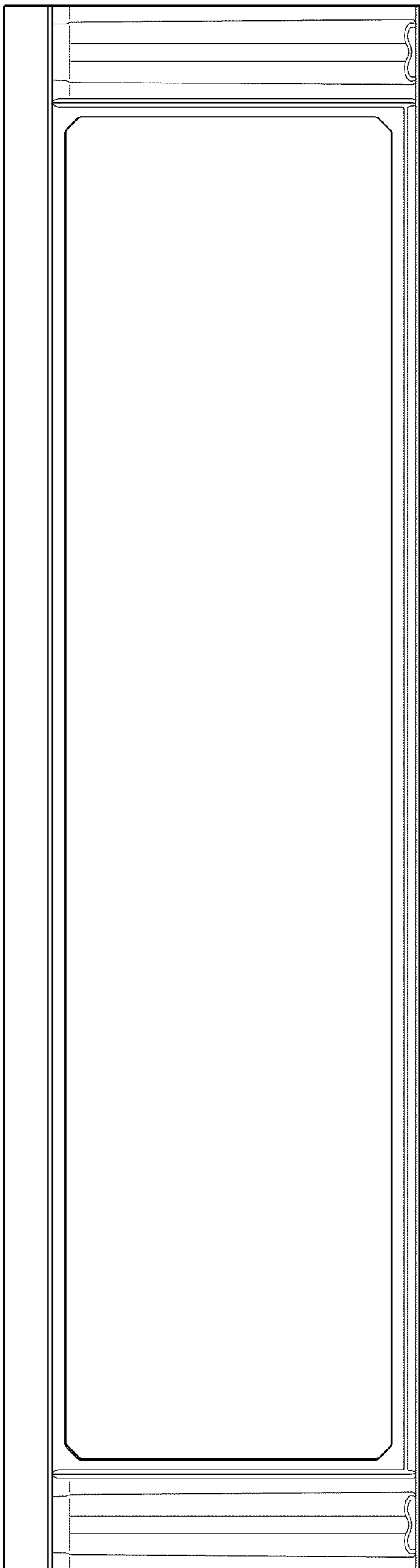

FIG. 3

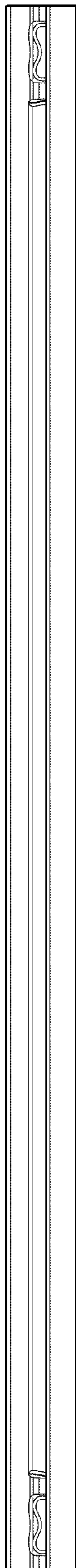

FIG. 4

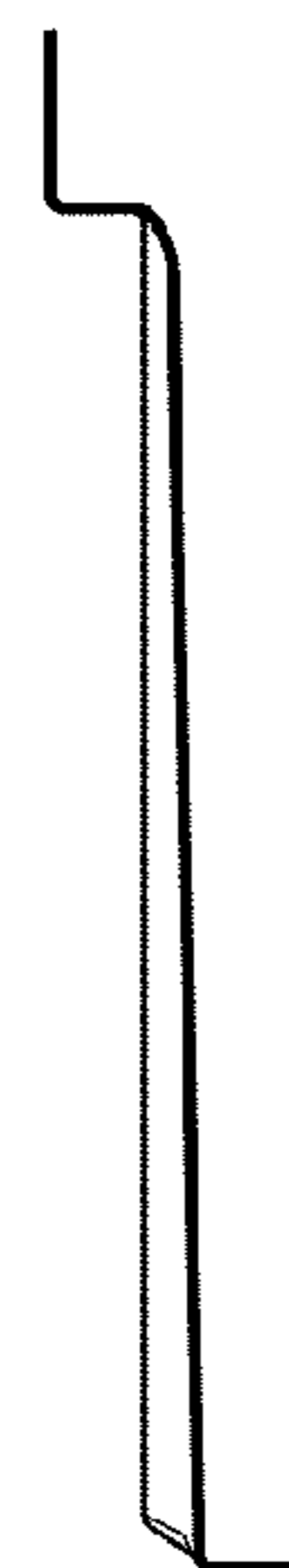

FIG. 5

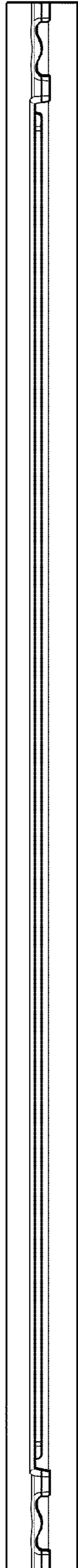

FIG. 6

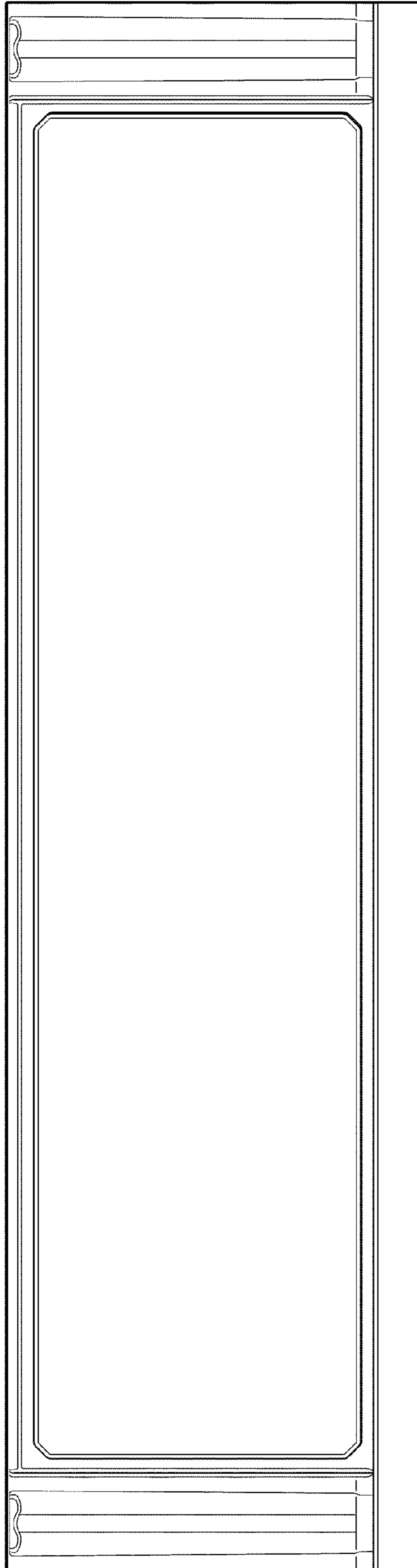

FIG. 7