



US00D653298S

(12) **United States Design Patent**  
**Werre et al.**

(10) **Patent No.:** **US D653,298 S**

(45) **Date of Patent:** **\*\* Jan. 31, 2012**

(54) **GOLF CLUB STAND**

(76) Inventors: **Jeffrey S. Werre**, Kent, WA (US);  
**Ronald J. Werre**, Renton, WA (US)

(\*\*) Term: **14 Years**

(21) Appl. No.: **29/385,007**

(22) Filed: **Feb. 7, 2011**

(51) **LOC (9) Cl.** ..... **21-02**

(52) **U.S. Cl.** ..... **D21/796**

(58) **Field of Classification Search** ..... D21/789,  
D21/796; D6/552; 211/70.2; 473/282  
See application file for complete search history.

(56) **References Cited**

**U.S. PATENT DOCUMENTS**

D318,090	S	*	7/1991	Bahns	.....	D21/796
5,127,530	A	*	7/1992	Ortuno	.....	473/282
D360,248	S		7/1995	Wright		
D363,849	S	*	11/1995	Bruns et al.	.....	D6/552
5,467,980	A	*	11/1995	Weisenstein	.....	473/282
D371,590	S	*	7/1996	Ludwig	.....	D21/796
D400,611	S	*	11/1998	Schoenbeck	.....	D21/796
D400,612	S	*	11/1998	Rubin	.....	D21/796
D407,774	S	*	4/1999	Weiss	.....	D21/796
D418,186	S	*	12/1999	Canterbury	.....	D21/796
D447,530	S	*	9/2001	Hidalgo	.....	D21/796
6,346,051	B1	*	2/2002	Otsubo	.....	473/282
D458,660	S		6/2002	Stealy		
6,419,592	B1	*	7/2002	Player	.....	473/282
D471,613	S	*	3/2003	Richardson	.....	D21/796
D475,864	S		6/2003	Thurman, Jr.		
D492,379	S	*	6/2004	Miavitz	.....	D21/796
D493,860	S	*	8/2004	Fox	.....	D21/796
D505,174	S		5/2005	Thomas, Sr.		

D520,098	S		5/2006	LeMoine		
D530,768	S	*	10/2006	Rood	.....	D21/796
D550,801	S	*	9/2007	Valiante	.....	D21/796
D564,614	S	*	3/2008	Valiante	.....	D21/796

\* cited by examiner

*Primary Examiner* — Mitchell Siegel

(74) *Attorney, Agent, or Firm* — QuickPatents, Inc.; Kevin Prince

(57) **CLAIM**

The ornamental design for a golf club stand, as shown and described.

**DESCRIPTION**

FIG. 1 is a perspective view of a first embodiment of a golf club stand, showing the new design;  
 FIG. 2 is a front elevational view thereof;  
 FIG. 3 is a left-side elevational view thereof, the right-side elevational view being a mirror image thereof;  
 FIG. 4 is a rear elevational view thereof;  
 FIG. 5 is a top plan view thereof;  
 FIG. 6 is a bottom plan view thereof;  
 FIG. 7 is a perspective view of a second embodiment of the design;  
 FIG. 8 is a front elevational view of FIG. 7;  
 FIG. 9 is a left-side elevational view of FIG. 7, the right-side elevational view being a mirror image thereof;  
 FIG. 10 is a rear elevational view of FIG. 7;  
 FIG. 11 is a top plan view of FIG. 7; and,  
 FIG. 12 is a bottom plan view thereof.  
 The broken lines showing a ground surface and golf clubs in FIG. 1 illustrate environmental matter as the invention is in use, and form no part of the claimed design.

**1 Claim, 3 Drawing Sheets**

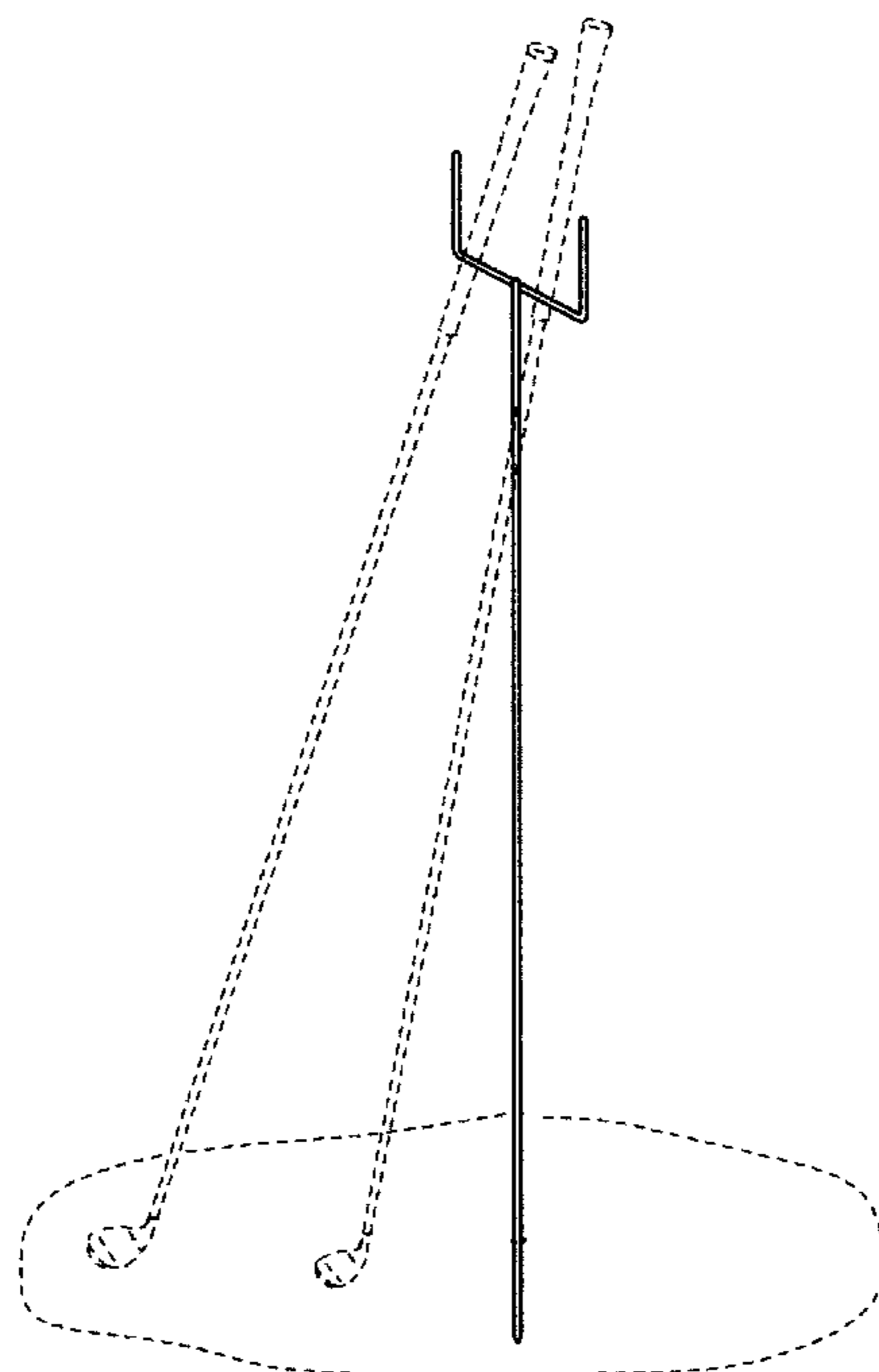
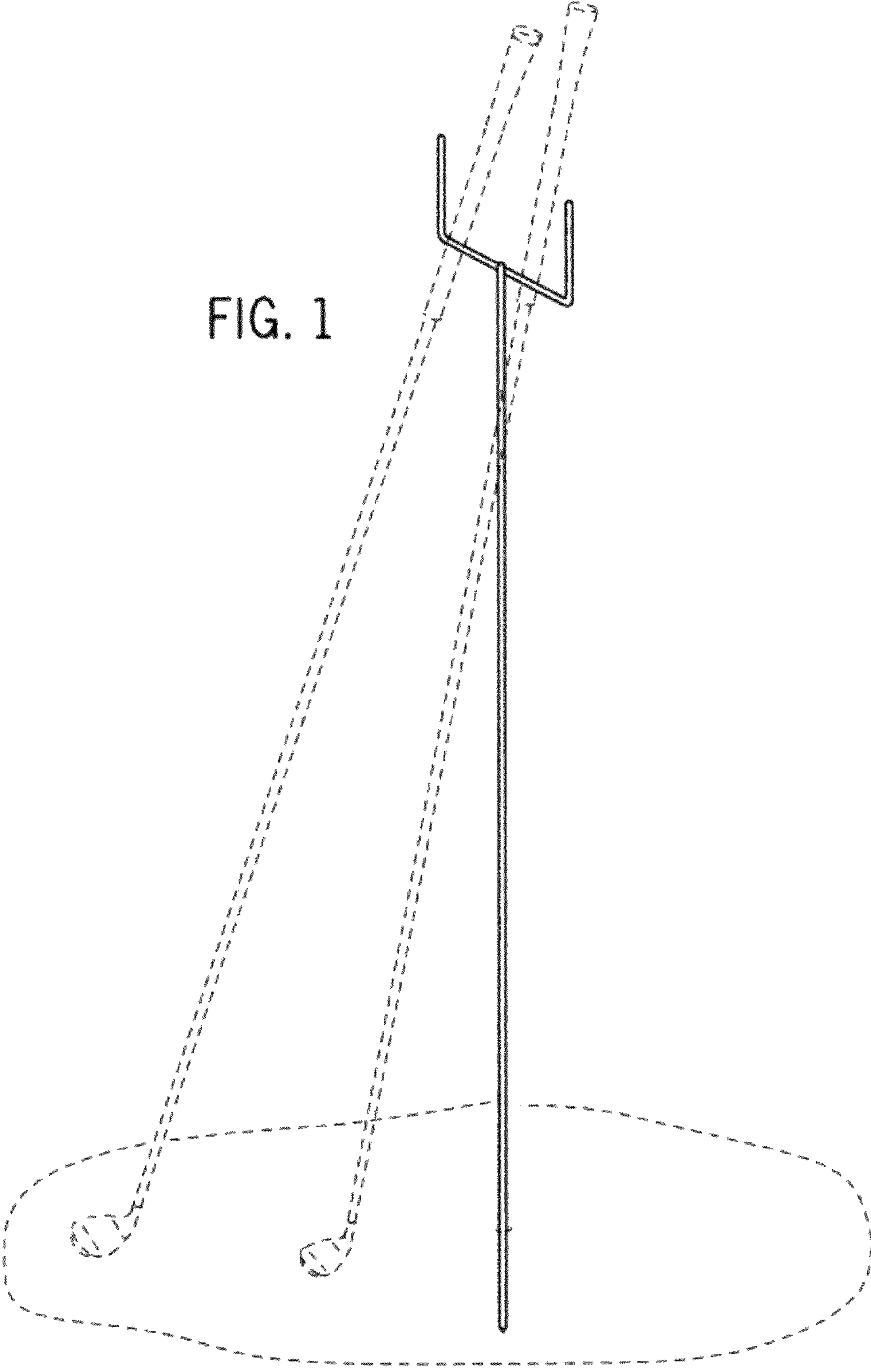

FIG. 1



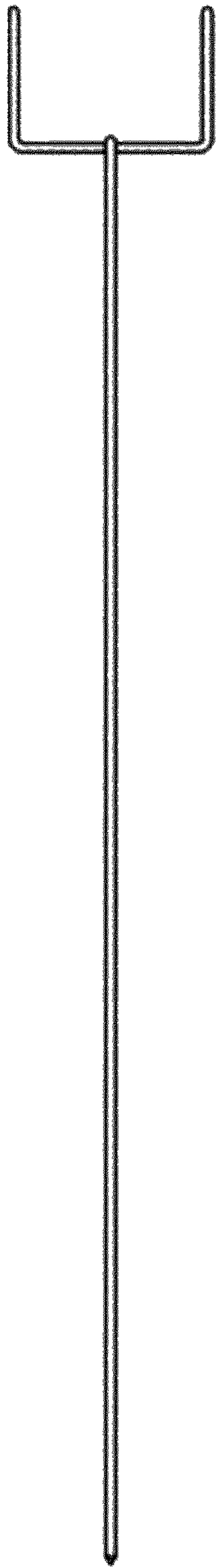

FIG. 2



FIG. 3

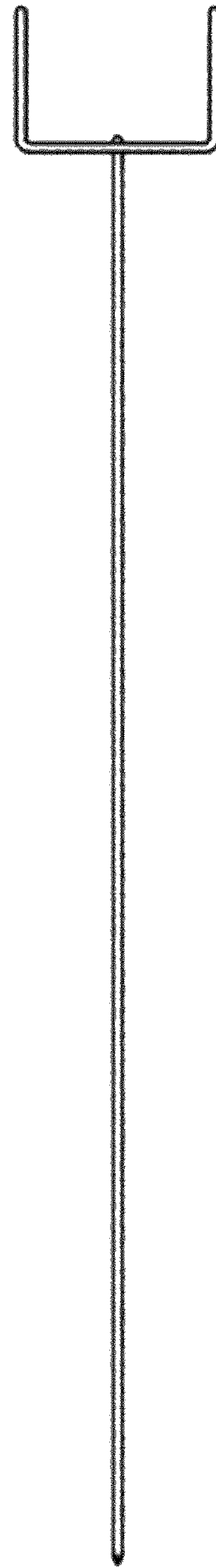

FIG. 4

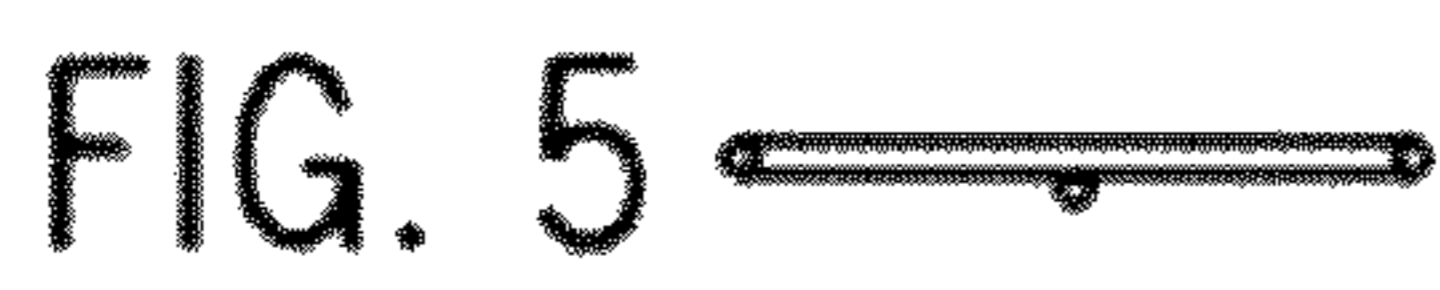

FIG. 5

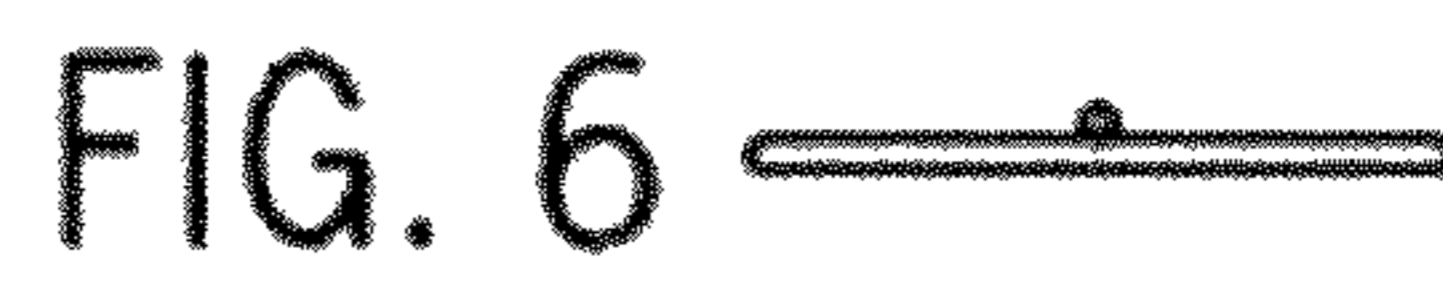

FIG. 6

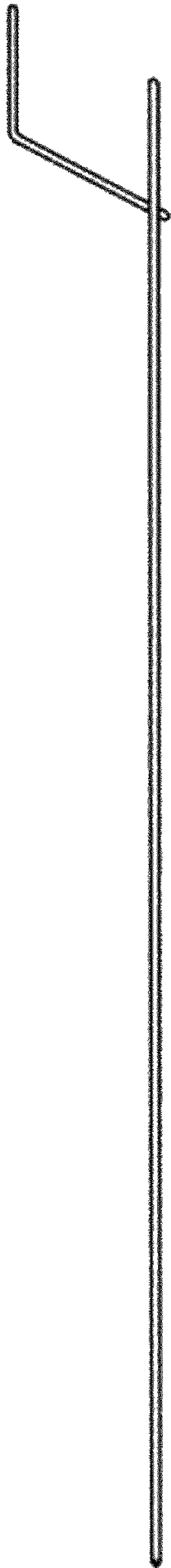

FIG. 7

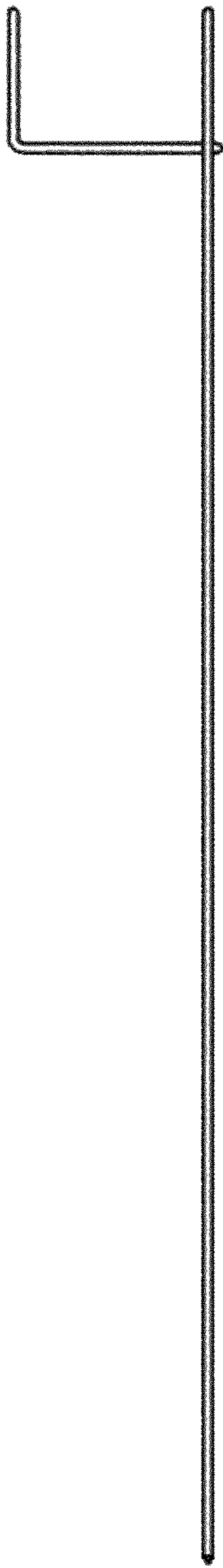

FIG. 8



FIG. 9

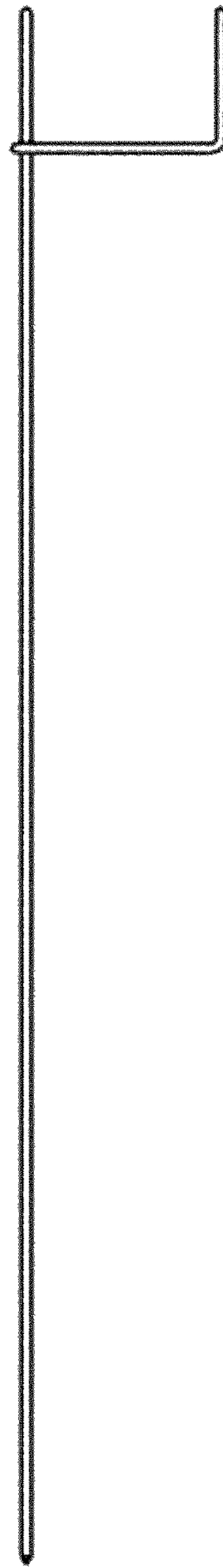

FIG. 10

