



US00D653231S

(12) **United States Design Patent**
Härenstam

(10) **Patent No.:** **US D653,231 S**

(45) **Date of Patent:** **** Jan. 31, 2012**

(54) **MOBILE PHONE**

(75) Inventor: **Karin Härenstam**, Lund (SE)

(73) Assignee: **Sony Ericsson Mobile Communications AB**, Lund (SE)

(**) Term: **14 Years**

(21) Appl. No.: **29/392,894**

(22) Filed: **May 27, 2011**

(30) **Foreign Application Priority Data**

Dec. 8, 2010 (EM) 001248496-0001

Dec. 8, 2010 (EM) 001248496-0002

(51) **LOC (9) Cl.** **14-03**

(52) **U.S. Cl.** **D14/138 AD**

(58) **Field of Classification Search** D14/138 AD,
D14/138 G, 138 R, 138 AC, 138 C, 496,
D14/341, 345, 346, 203.7, 247, 248, 218,
D14/138 AA, 138 AB; 455/575.1, 556.2,
455/556.1, 575.4, 566; D10/65; D13/168
See application file for complete search history.

(56) **References Cited**

U.S. PATENT DOCUMENTS

D548,713	S	*	8/2007	Lee et al.	D14/138 AD
D558,720	S	*	1/2008	Lee et al.	D14/138 AD
D571,234	S	*	6/2008	Reeson et al.	D10/65
D578,098	S	*	10/2008	Oh	D14/138 AD
D578,503	S	*	10/2008	Shin et al.	D14/138 AD
D581,894	S	*	12/2008	Kim	D14/138 G
D589,924	S	*	4/2009	Jung et al.	D14/138 AD
D602,463	S	*	10/2009	Eguchi	D14/138 G
D603,356	S	*	11/2009	Sterzick et al.	D14/138 G
D604,715	S	*	11/2009	Shimizu et al.	D14/203.7
D611,025	S	*	3/2010	Yu	D14/138 G
D611,924	S	*	3/2010	Ou et al.	D14/138 AD
D615,946	S	*	5/2010	Mun	D14/138 G
D619,989	S	*	7/2010	Huang	D14/138 G
D629,375	S	*	12/2010	Han et al.	D14/138 AD
D629,776	S	*	12/2010	Lee et al.	D14/138 AD
D631,464	S	*	1/2011	Kim	D14/138 G
D631,864	S	*	2/2011	Jung	D14/138 AB
D632,665	S	*	2/2011	Kim et al.	D14/138 G
D633,459	S	*	3/2011	Suzuki	D14/138 G
D633,462	S	*	3/2011	Mauritzson	D14/138 AD
D635,136	S	*	3/2011	Jiang et al.	D14/341

7,929,284	B2	*	4/2011	Shen	361/679.21
D639,767	S	*	6/2011	Finney et al.	D14/138 G
D640,221	S	*	6/2011	Lee et al.	D14/138 AD
D644,196	S	*	8/2011	Lee et al.	D14/138 AD
D644,219	S	*	8/2011	Sawada	D14/345
D645,834	S	*	9/2011	Lee et al.	D14/138 AD
2007/0232368	A1	*	10/2007	Feightner et al.	455/575.1
2008/0274776	A1	*	11/2008	Cho et al.	455/575.4
2009/0024926	A1	*	1/2009	Morotomi	715/716
2010/0304802	A1	*	12/2010	Chuang et al.	455/575.4

OTHER PUBLICATIONS

Sony Ericsson Mix Walkman telephone, announced Jun. 2011, [online]. [site visited Sep. 20, 2011]. Available from Internet, <URL: <http://www.gsmarena.com>>.*

(Continued)

Primary Examiner — Jeffrey D Asch

(74) *Attorney, Agent, or Firm* — Renner, Otto, Boisselle & Sklar, LLP

(57) **CLAIM**

The ornamental design for a mobile phone, as shown and described.

DESCRIPTION

FIG. 1 is a perspective view of a mobile phone in a closed position showing my design;
FIG. 2 is front view thereof;
FIG. 3 is a rear view thereof;
FIG. 4 is a right side view thereof;
FIG. 5 is a left side view thereof;
FIG. 6 is a bottom view thereof;
FIG. 7 is a top view thereof;
FIG. 8 is a perspective view of the mobile phone in an open position;
FIG. 9 is a front view thereof;
FIG. 10 is a rear view thereof;
FIG. 11 is a right side view thereof;
FIG. 12 is a left side view thereof;
FIG. 13 is a bottom thereof; and,
FIG. 14 is a top view thereof.

1 Claim, 5 Drawing Sheets

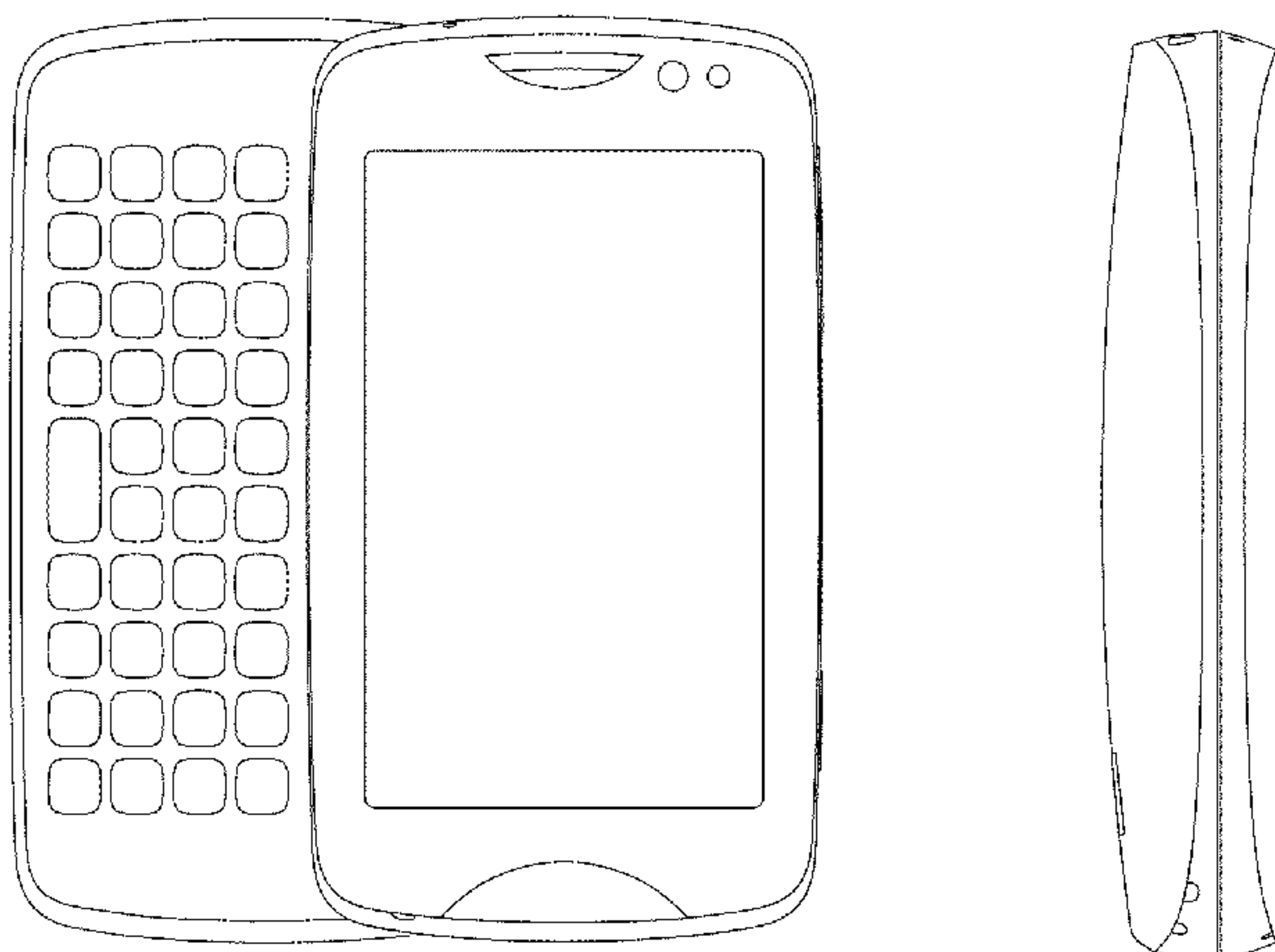

OTHER PUBLICATIONS

Sony Ericsson txt pro telephone, announced Jun. 2011, [online], [site visited Sep. 20, 2011]. Available from Internet, <URL: <http://www.gsmarena.com>>.*

Sony Ericsson Xperia mini telephone, announced May 2011, [online], [site visited Sep. 20, 2011]. Available from Internet, <URL: <http://www.gsmarena.com>>.*

Sony Ericsson Xperia mini pro telephone, announced May 2011, [online], [site visited Sep. 20, 2011]. Available from Internet, <URL: <http://www.gsmarena.com>>.*

Samsung B7610 OmniaPRO telephone, announced Jun. 2009, [online], [site visited Sep. 20, 2011]. Available from Internet, <URL: <http://www.gsmarena.com>>.*

LG EGO Wi-Fi telephone, announced Jun. 2011, [online], [site visited Sep. 20, 2011]. Available from Internet, <URL: <http://www.gsmarena.com>>.*

Sony Ericsson WT18i telephone, announced May 2011, [online], [site visited Sep. 20, 2011]. Available from Internet, <URL: <http://www.gsmarena.com>>.*

* cited by examiner

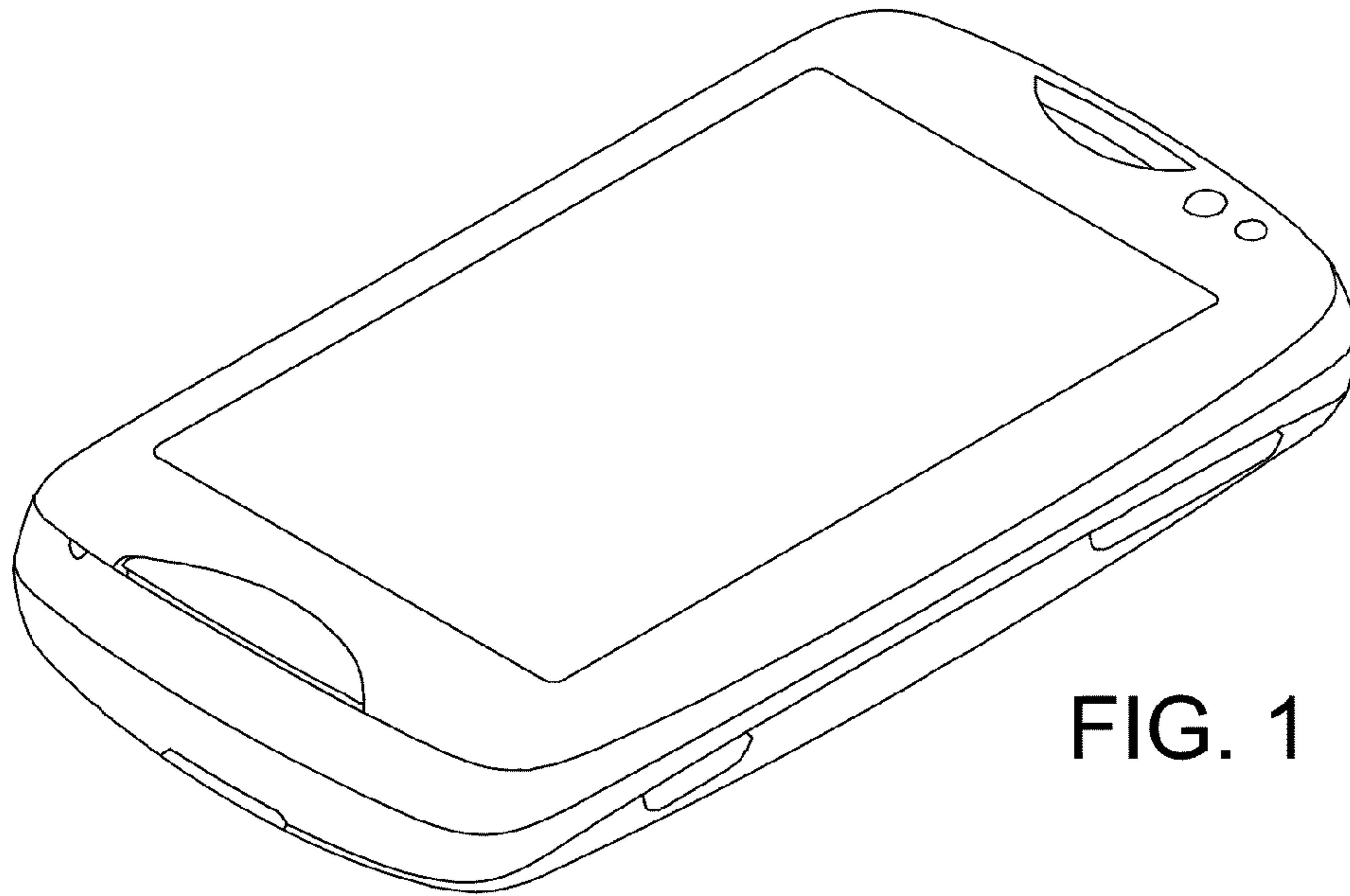

FIG. 1

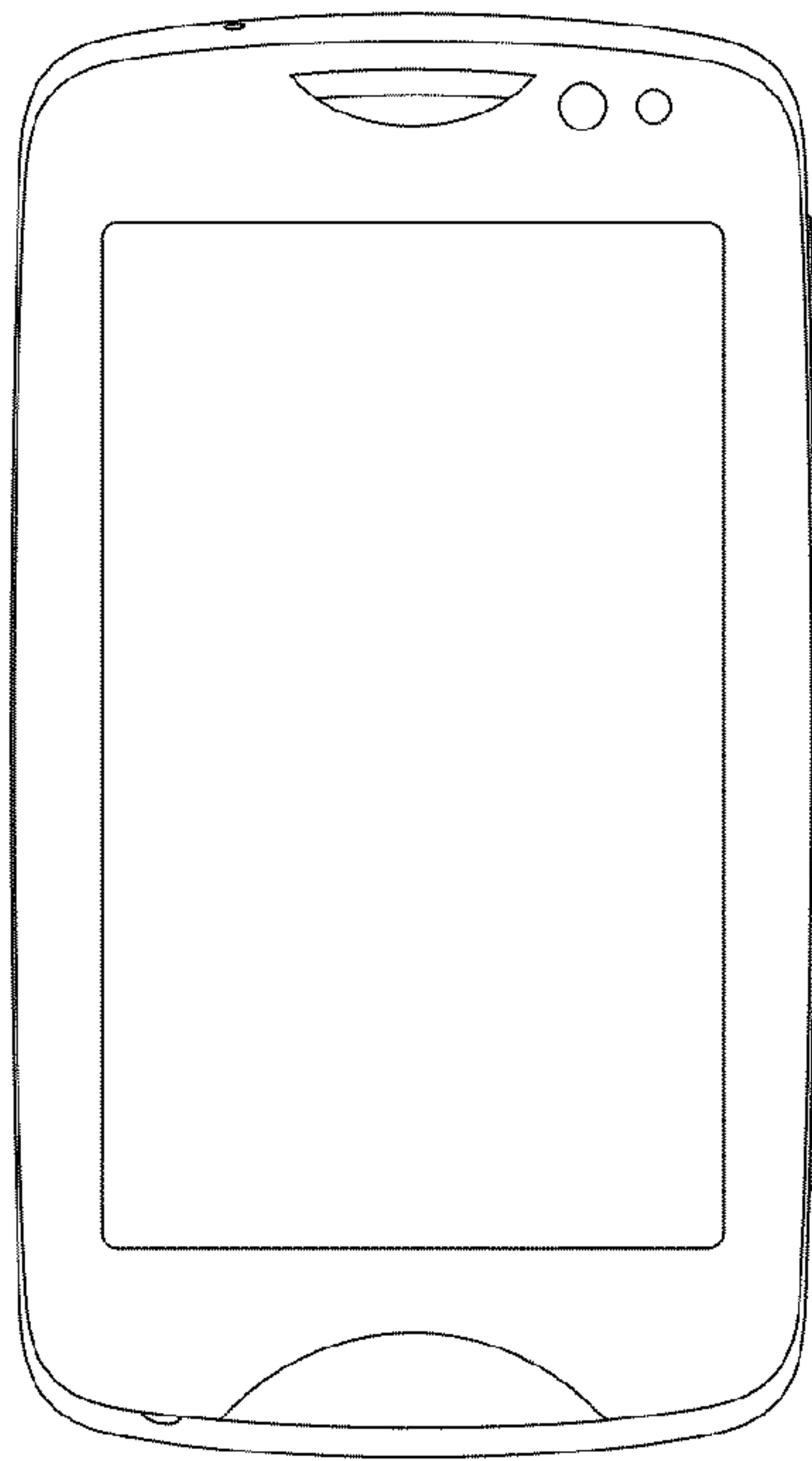

FIG. 2

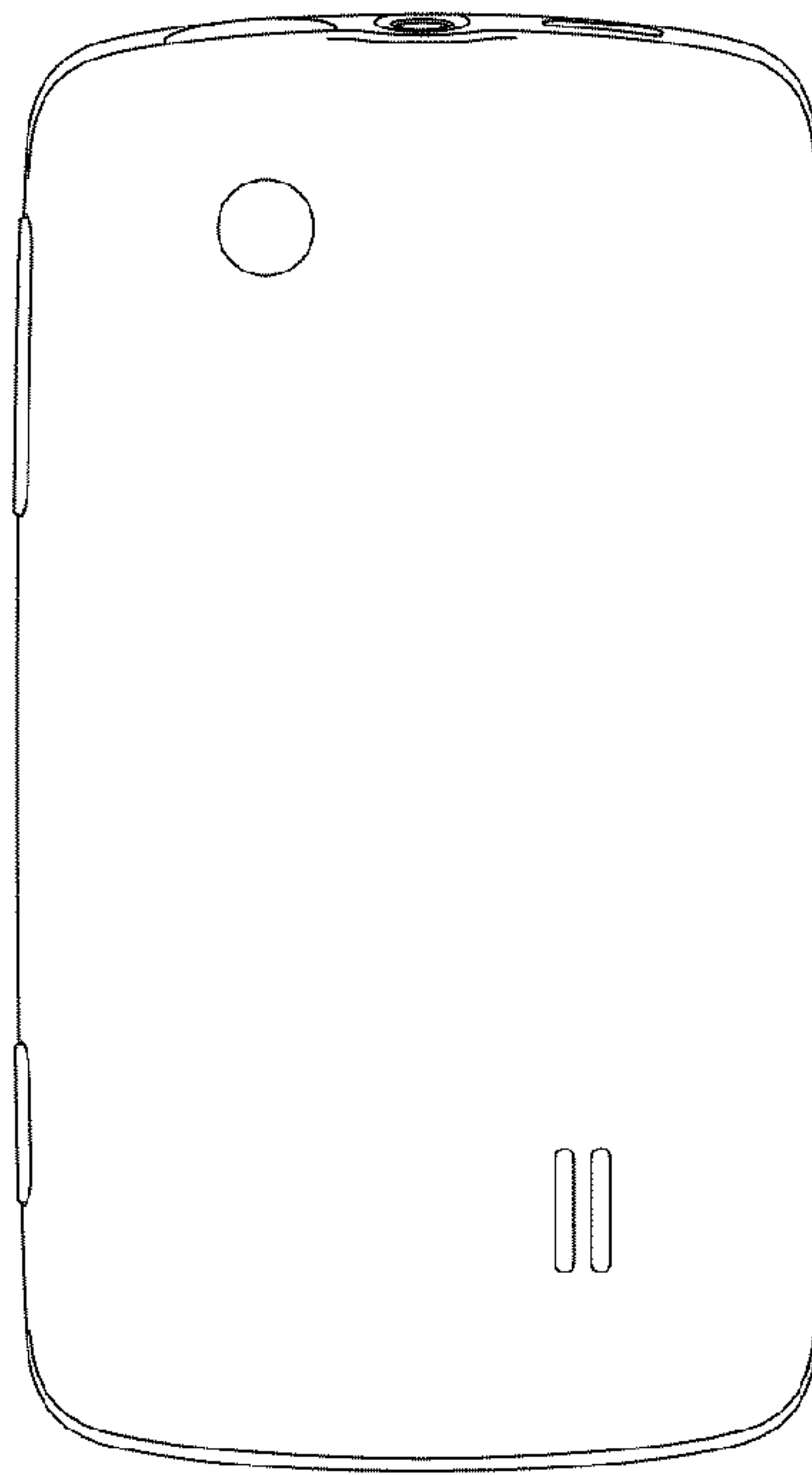

FIG. 3

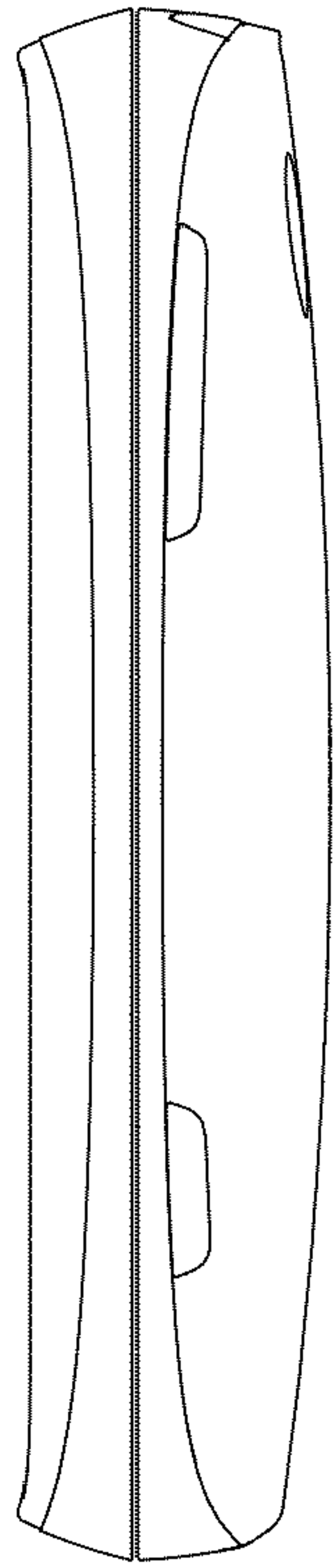

FIG. 4

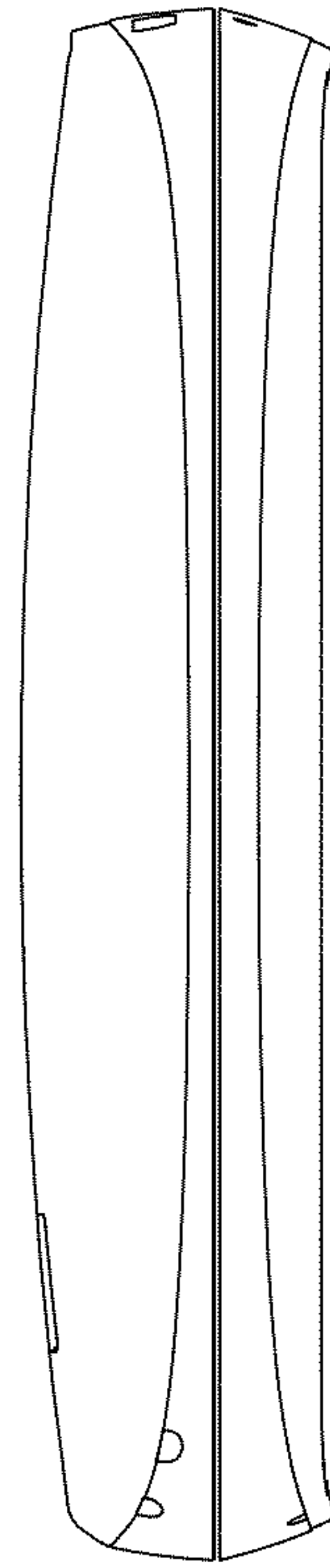

FIG. 5

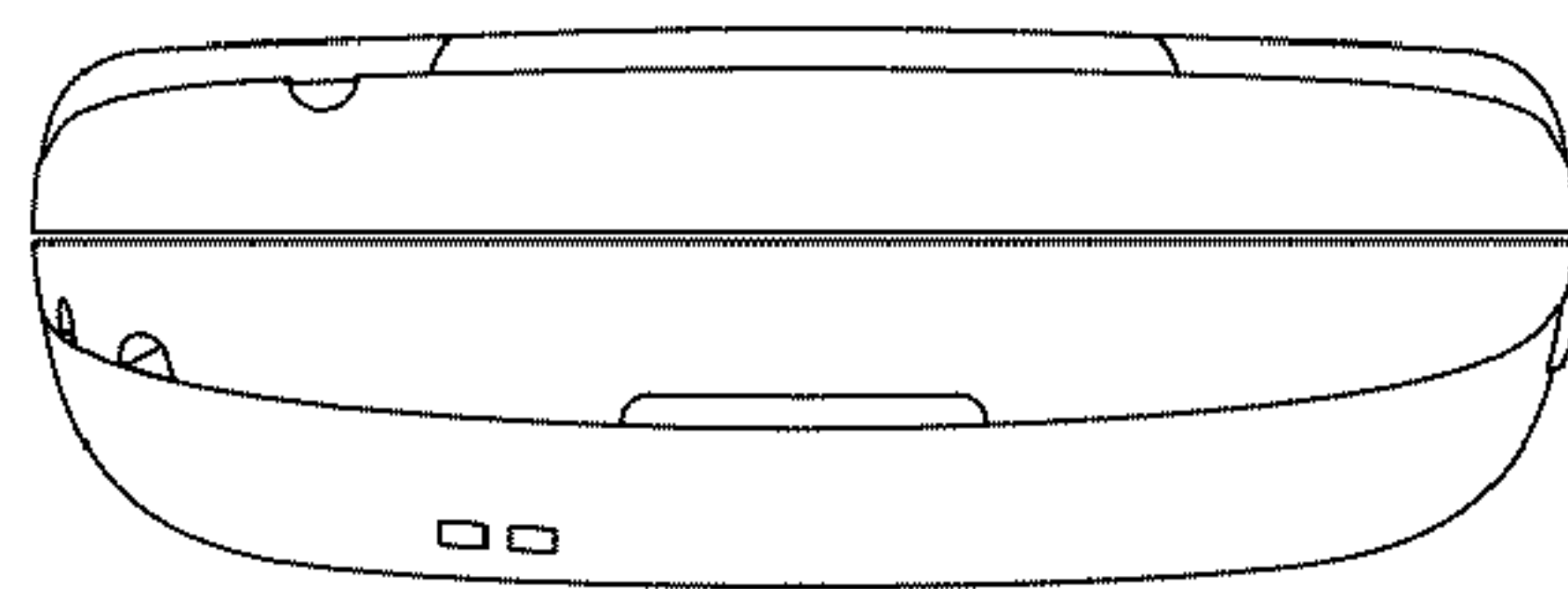

FIG. 6

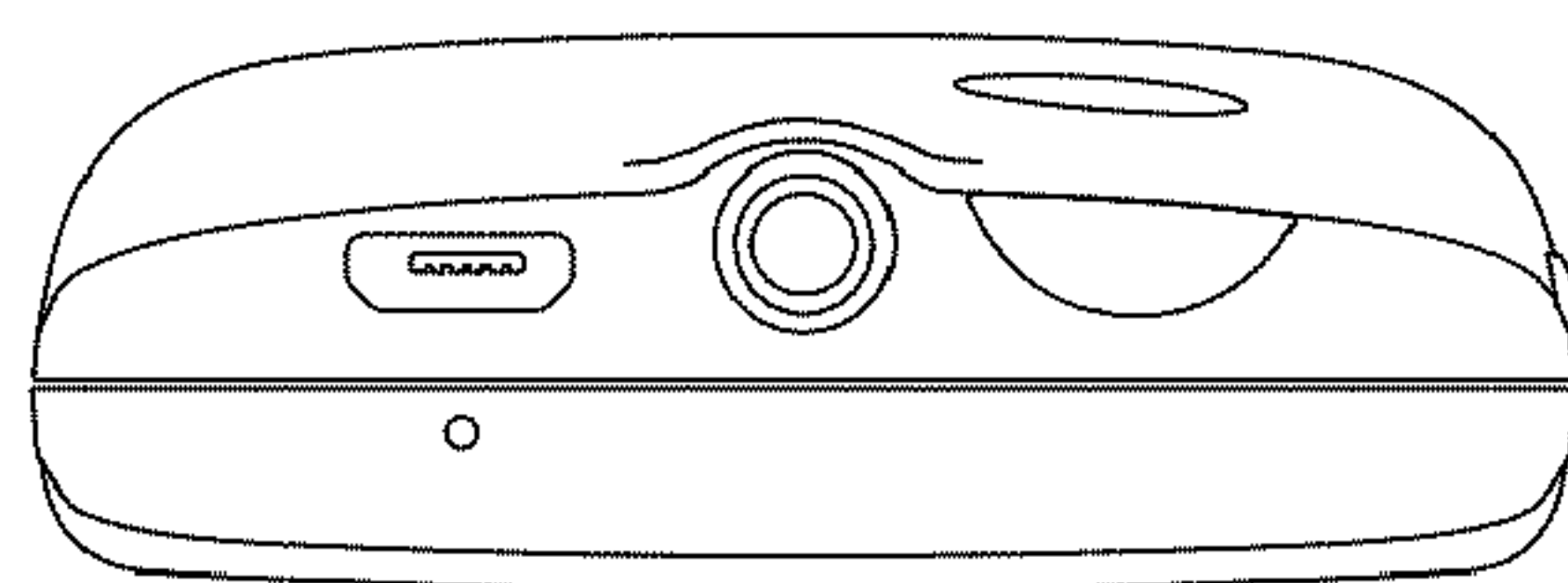

FIG. 7

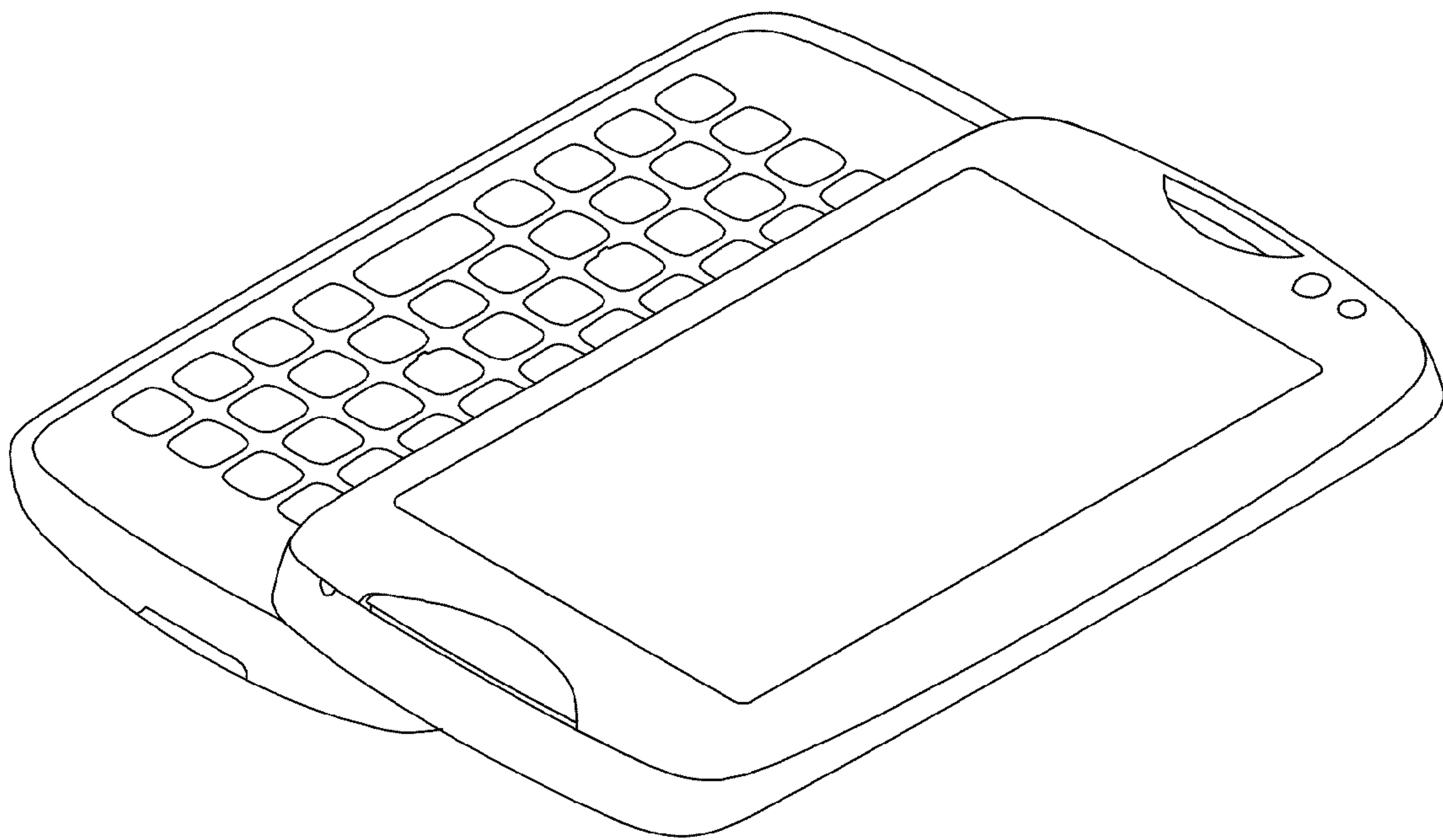

FIG. 8

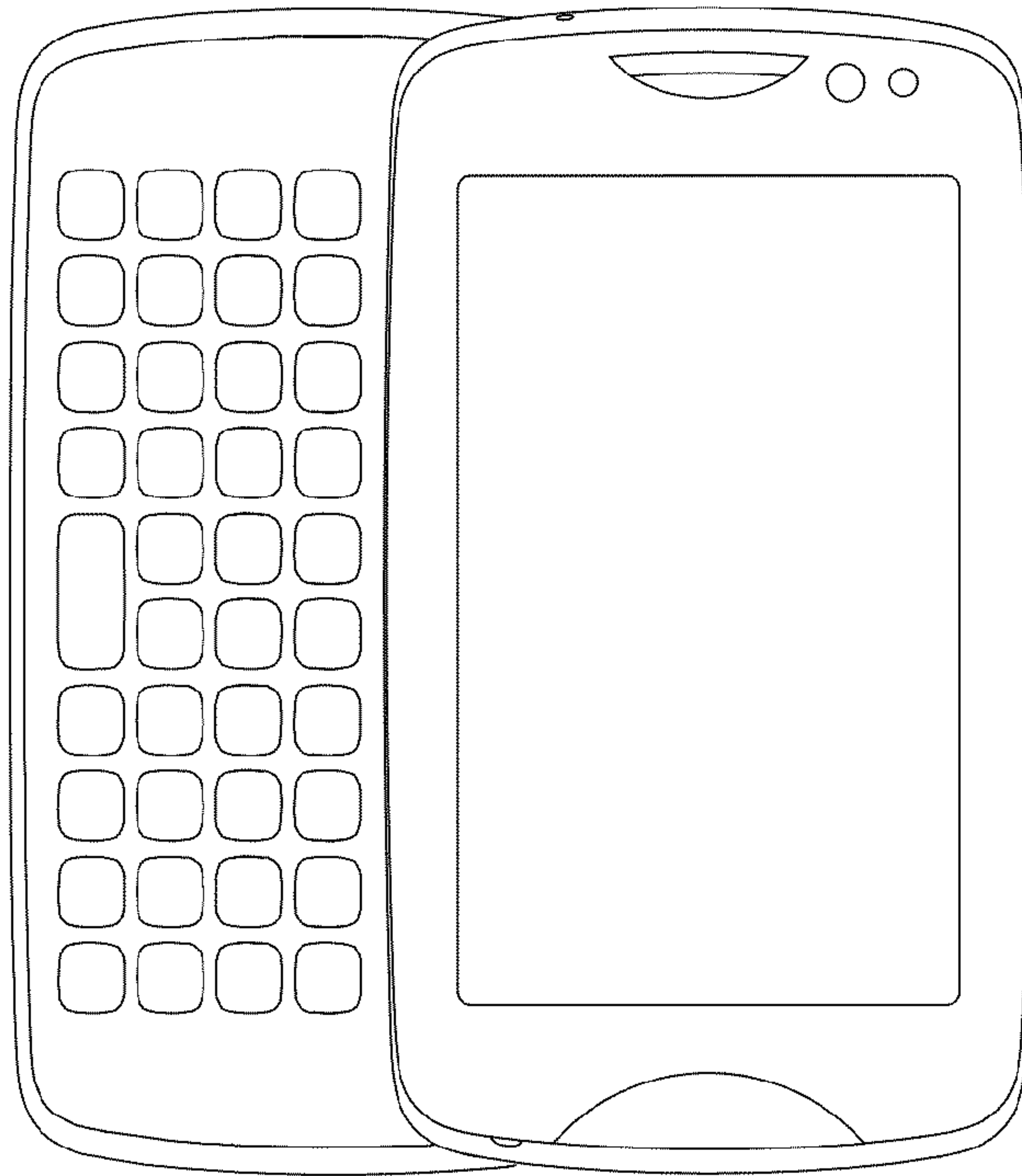

FIG. 9

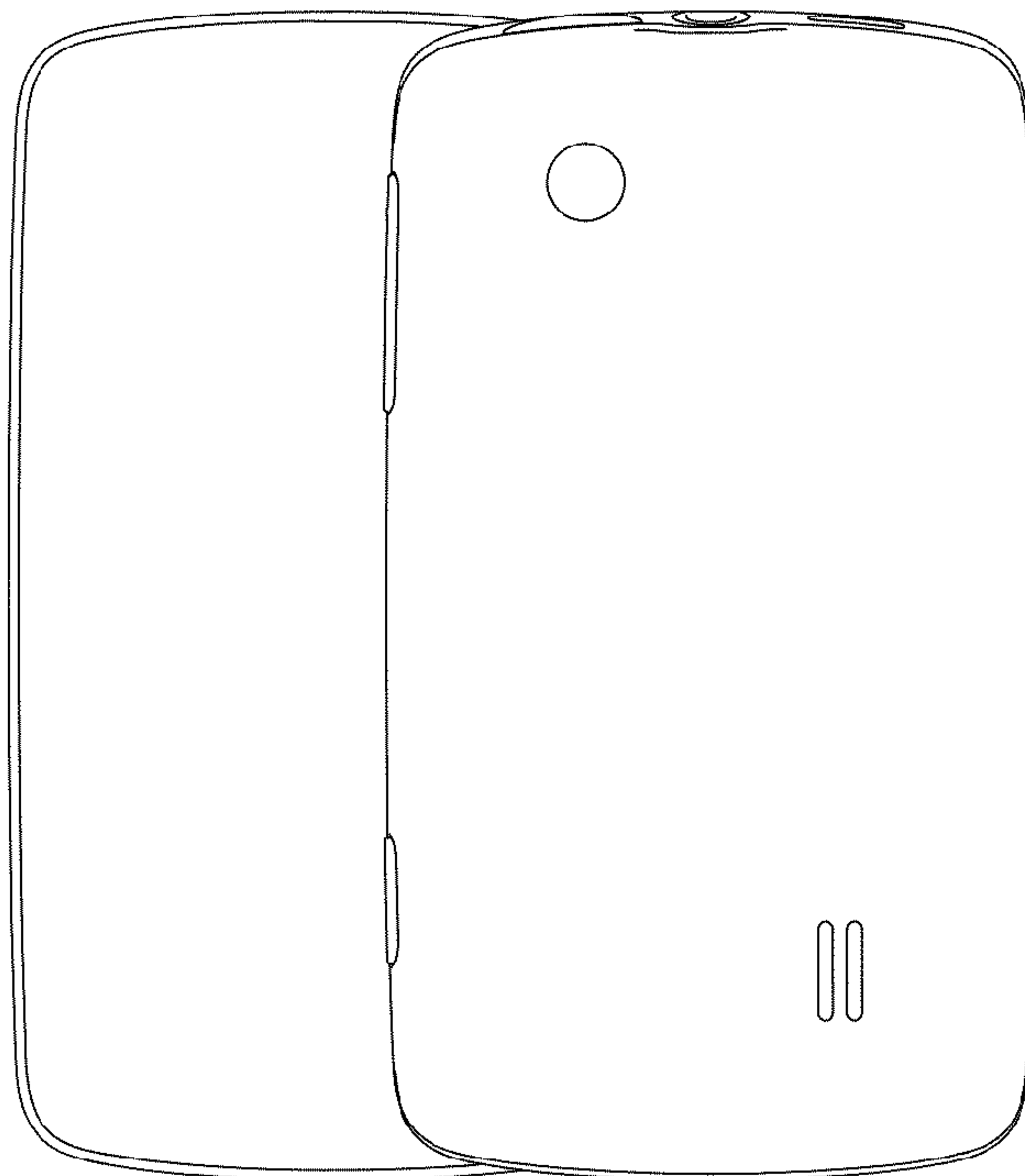

FIG. 10

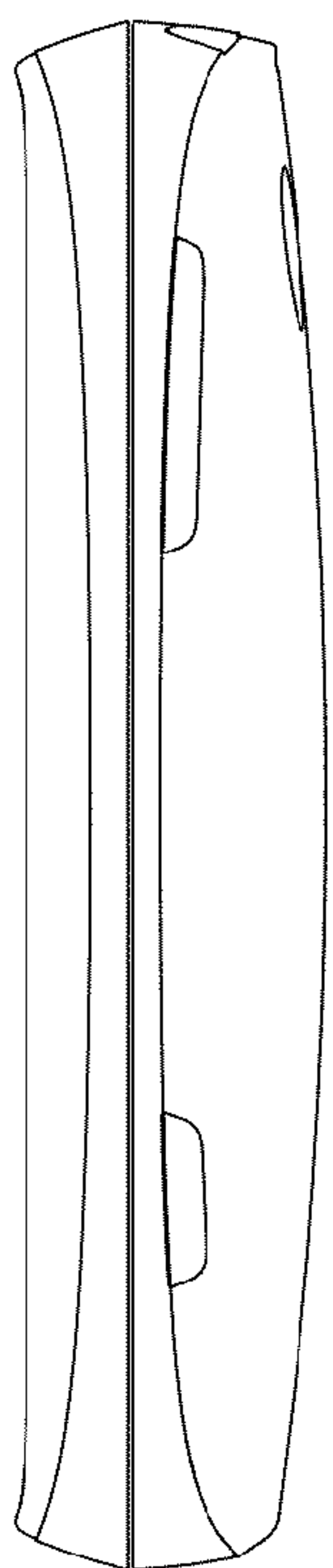

FIG. 11

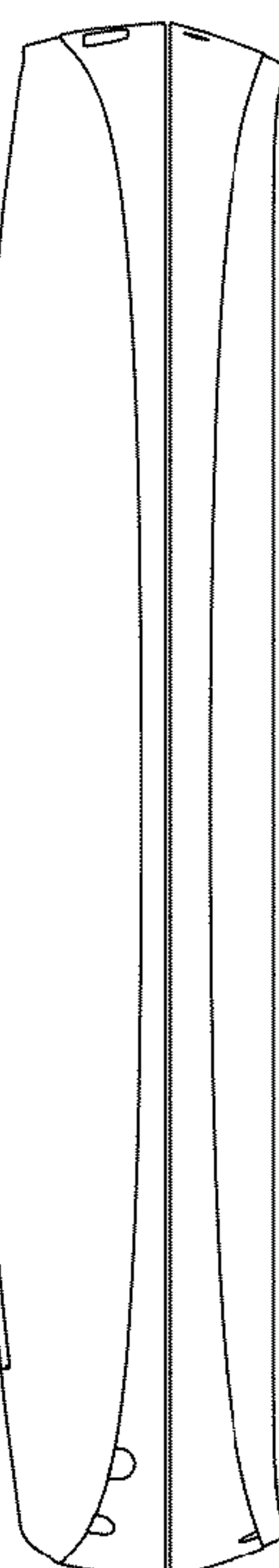

FIG. 12

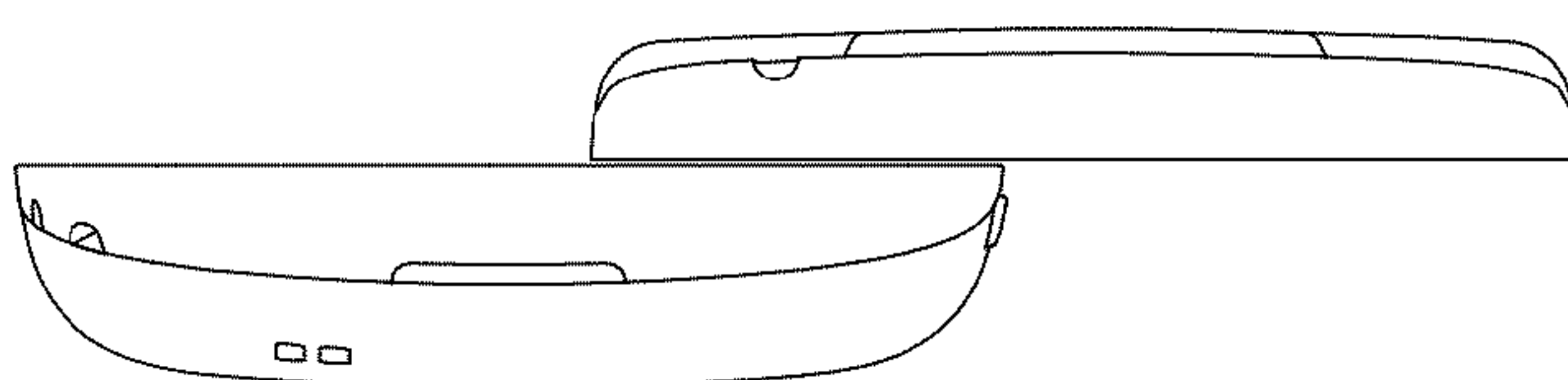

FIG. 13

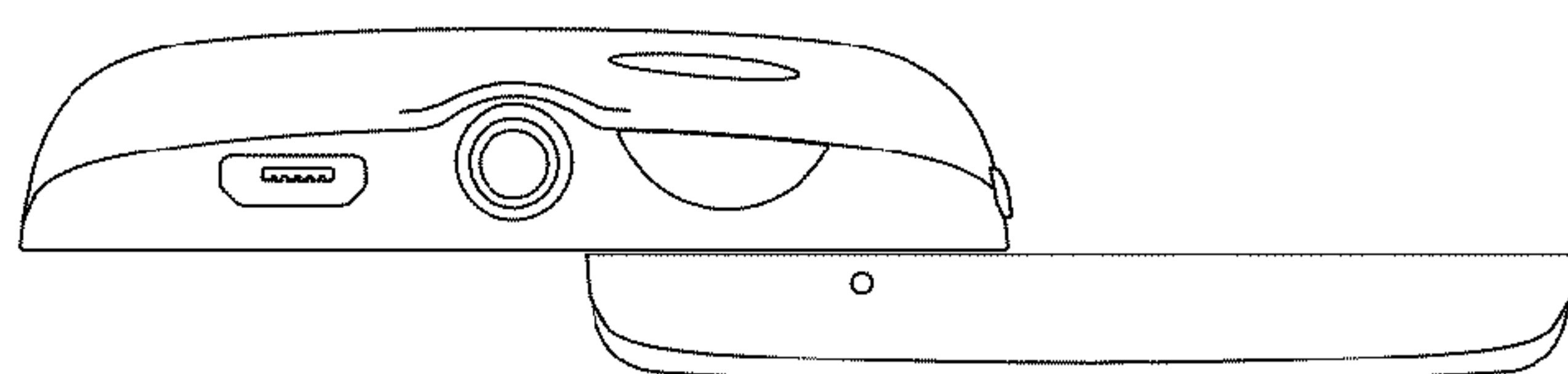

FIG. 14