



US00D653202S

(12) **United States Design Patent**  
**Hasbrook et al.**

(10) **Patent No.:** **US D653,202 S**  
(45) **Date of Patent:** **\*\* Jan. 31, 2012**

(54) **BATTERY CASE**

(75) Inventors: **William Benjamin Hasbrook**, Tualatin, OR (US); **Sean Michael Stuck**, Portland, OR (US); **Matthew Brand**, Brooklyn, NY (US); **Daniel Huang**, Irvine, CA (US)

(73) Assignee: **Mophie, Inc.**, Santa Ana, CA (US)

(\*\*) Term: **14 Years**

(21) Appl. No.: **29/369,362**

(22) Filed: **Sep. 7, 2010**

(51) **LOC (9) Cl.** ..... **13-02**

(52) **U.S. Cl.** ..... **D13/103**

(58) **Field of Classification Search** ..... D13/102-110,  
D13/118-119, 184, 199; D14/250, 251,  
D14/253, 432, 434; 320/101-102, 107-115;  
D3/201, 215, 218, 226, 230, 299; 429/96-100,  
429/163, 176; 206/320, 701

See application file for complete search history.

(56) **References Cited**

U.S. PATENT DOCUMENTS

D327,868 S *	7/1992	Oka	.....	D13/110
D407,063 S *	3/1999	Reis et al.	.....	D13/103
D460,411 S *	7/2002	Wang	.....	D13/103
D517,007 S *	3/2006	Yong-Jian et al.	.....	D13/108
D526,958 S *	8/2006	Shimizu	.....	D13/108

(Continued)

*Primary Examiner* — Rosemary K Tarcza

(74) *Attorney, Agent, or Firm* — Duane Morris LLP

(57) **CLAIM**

The ornamental design for a battery case, as shown and described.

**DESCRIPTION**

FIG. 1 is a exploded view of the battery case, showing the two halves of the battery case detached;

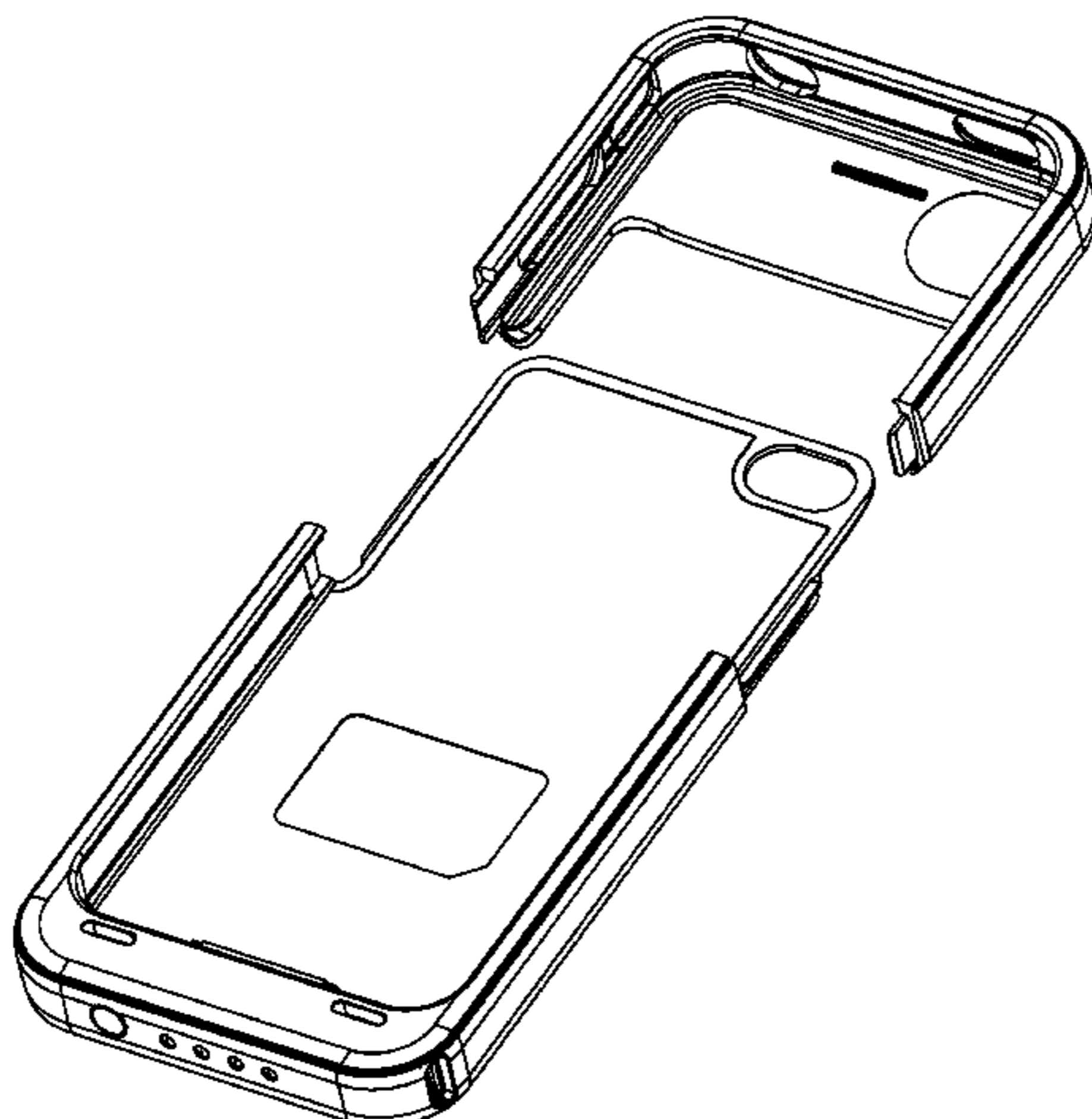

FIG. 2 is an exploded front view thereof;

FIG. 3 is an exploded rear view thereof;

FIG. 4 is an exploded left-hand side view thereof;

FIG. 5 is an exploded right-hand side view thereof;

FIG. 6 is a perspective view of a mobile phone enclosed within the battery case in broken lines;

FIG. 7 is a front view of a mobile phone enclosed within the battery case;

FIG. 8 is a perspective view of the battery case, with the bottom half removed for ease of illustration;

FIG. 9 is a front view thereof;

FIG. 10 is a rear view thereof;

FIG. 11 is a left-hand side view thereof;

FIG. 12 is a right-hand side view thereof;

FIG. 13 is a perspective view of the battery case, with the bottom half removed for ease of illustration;

FIG. 14 is a front view thereof;

FIG. 15 is a rear view thereof;

FIG. 16 is a left-hand side view thereof;

FIG. 17 is a right-hand side view thereof;

FIG. 18 is a perspective view of the battery case, with the top half removed for ease of illustration, showing a mobile phone enclosed within the battery case in broken lines;

FIG. 19 is a front view thereof;

FIG. 20 is a rear view thereof;

FIG. 21 is a left-hand side view thereof;

FIG. 22 is a right-hand side view thereof;

FIG. 23 is a perspective view of the battery case, showing the two halves of the battery case joined together;

FIG. 24 is a front view thereof;

FIG. 25 is a rear view thereof;

FIG. 26 is a top view thereof;

FIG. 27 is a bottom view thereof;

FIG. 28 is a left-hand side view thereof; and,

FIG. 29 is a right-hand side view thereof.

The broken lines showing the mobile phone are for the purpose of illustrating environmental structure, and forms no part of the claimed design.

**1 Claim, 29 Drawing Sheets**



# US D653,202 S

Page 2

---

## U.S. PATENT DOCUMENTS

D535,252 S *	1/2007	Sandnes .....	D13/108	D623,180 S *	9/2010	Diebel .....	D14/250
D556,681 S *	12/2007	Kim .....	D13/103	D623,640 S *	9/2010	Freeman .....	D14/250
D561,092 S *	2/2008	Kim .....	D13/103	D625,303 S *	10/2010	Kim .....	D14/250
D601,959 S *	10/2009	Lee et al. ....	D13/119	D626,538 S *	11/2010	Brown et al. ....	D14/250
D601,960 S *	10/2009	Dai .....	D13/119	D626,539 S *	11/2010	Brown et al. ....	D14/250
D616,360 S *	5/2010	Huang .....	D13/103	D636,386 S *	4/2011	Richardson et al. ....	D14/250
D616,361 S *	5/2010	Huang .....	D13/103	2009/0186264 A1 *	7/2009	Huang .....	429/96

\* cited by examiner

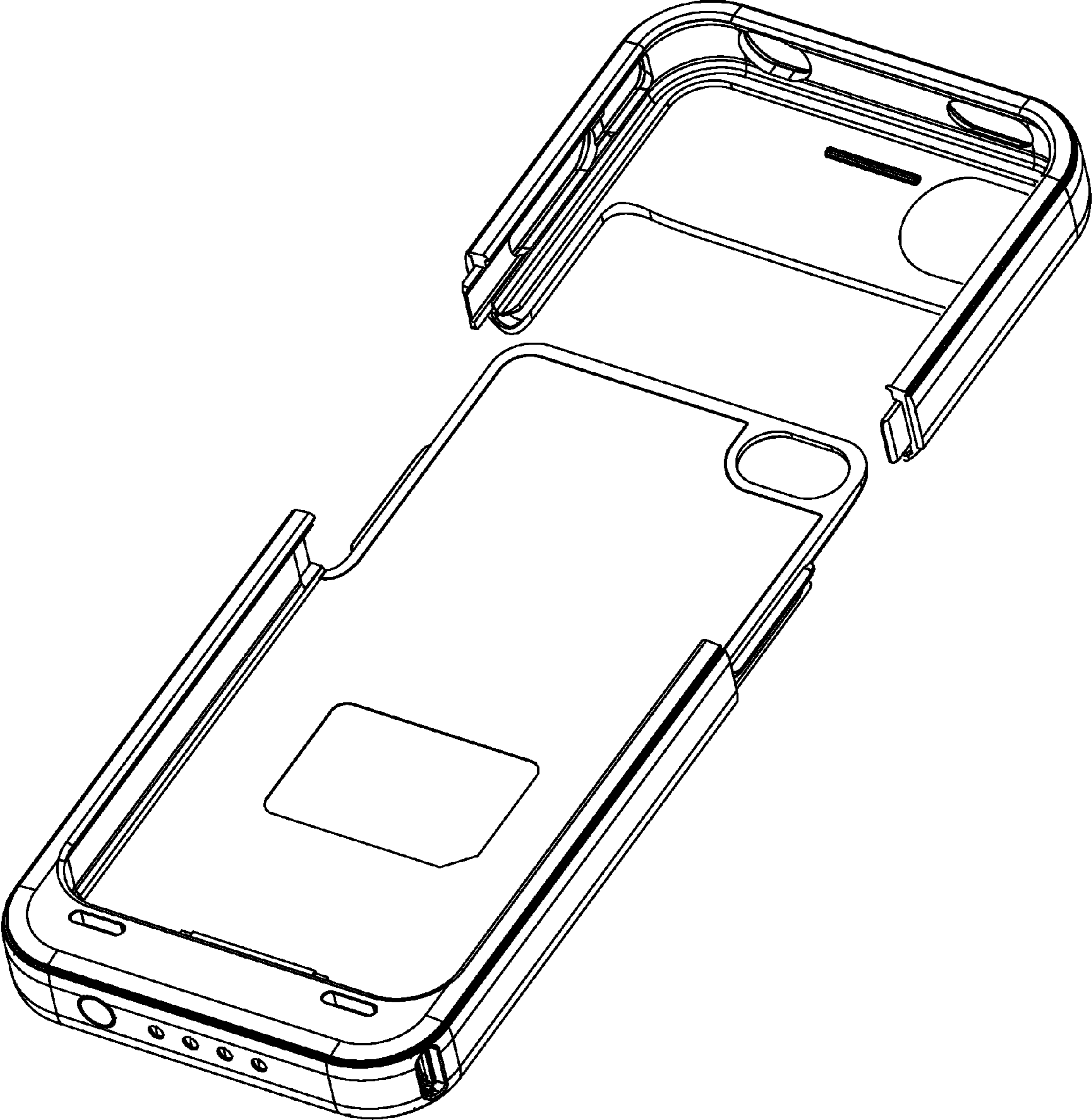

FIGURE 1

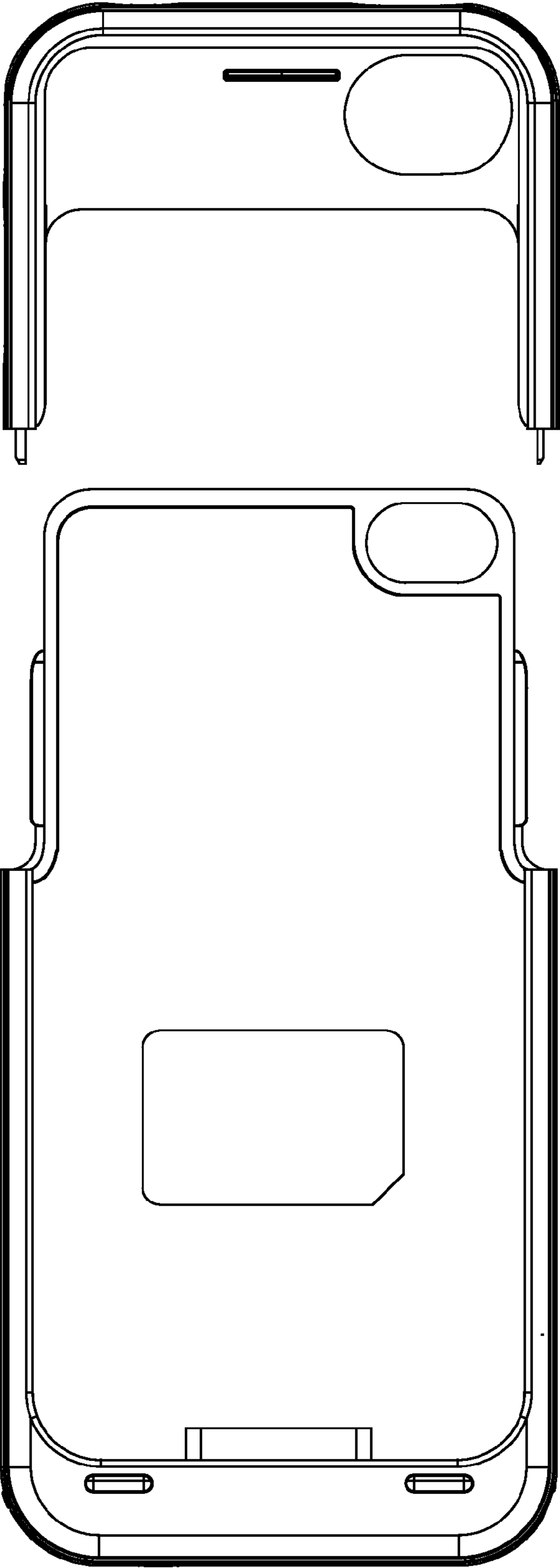

FIGURE 2



FIGURE 3

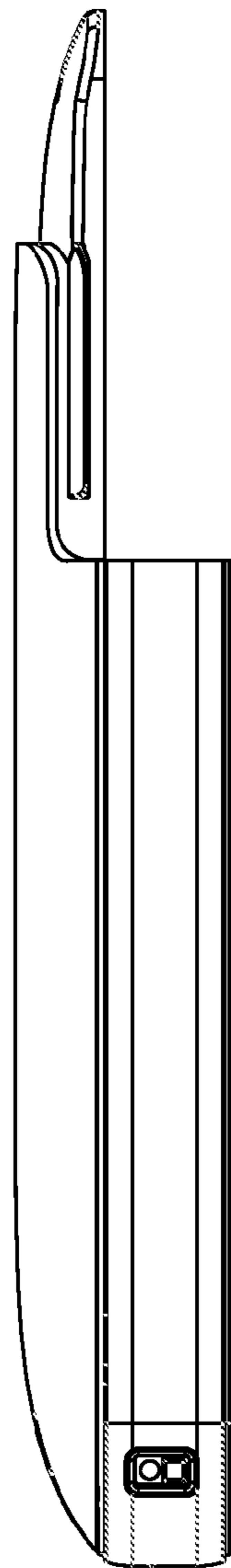
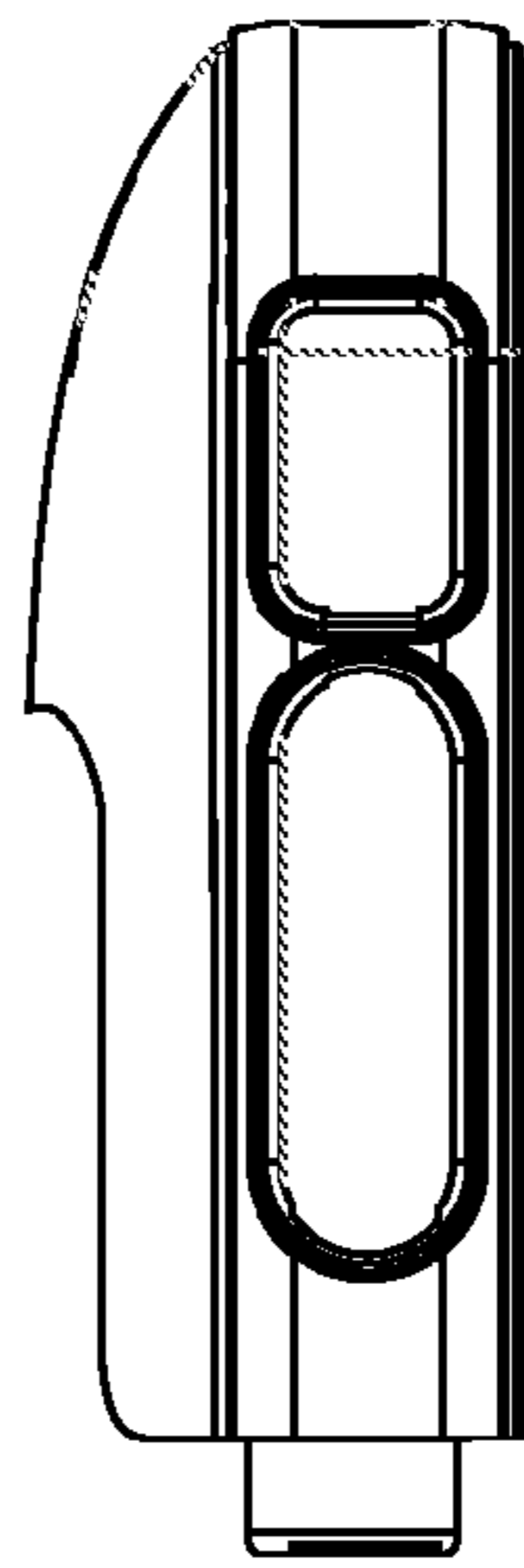

FIGURE 4

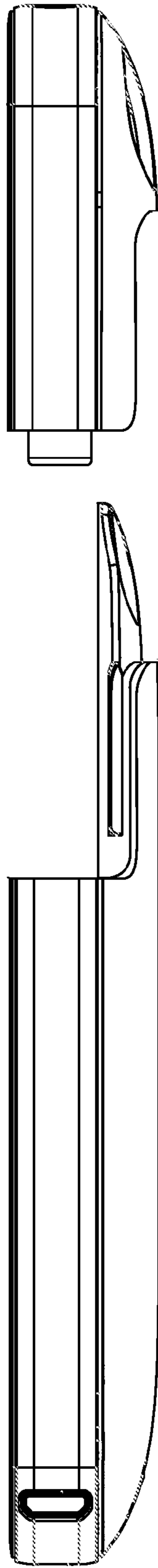

FIGURE 5

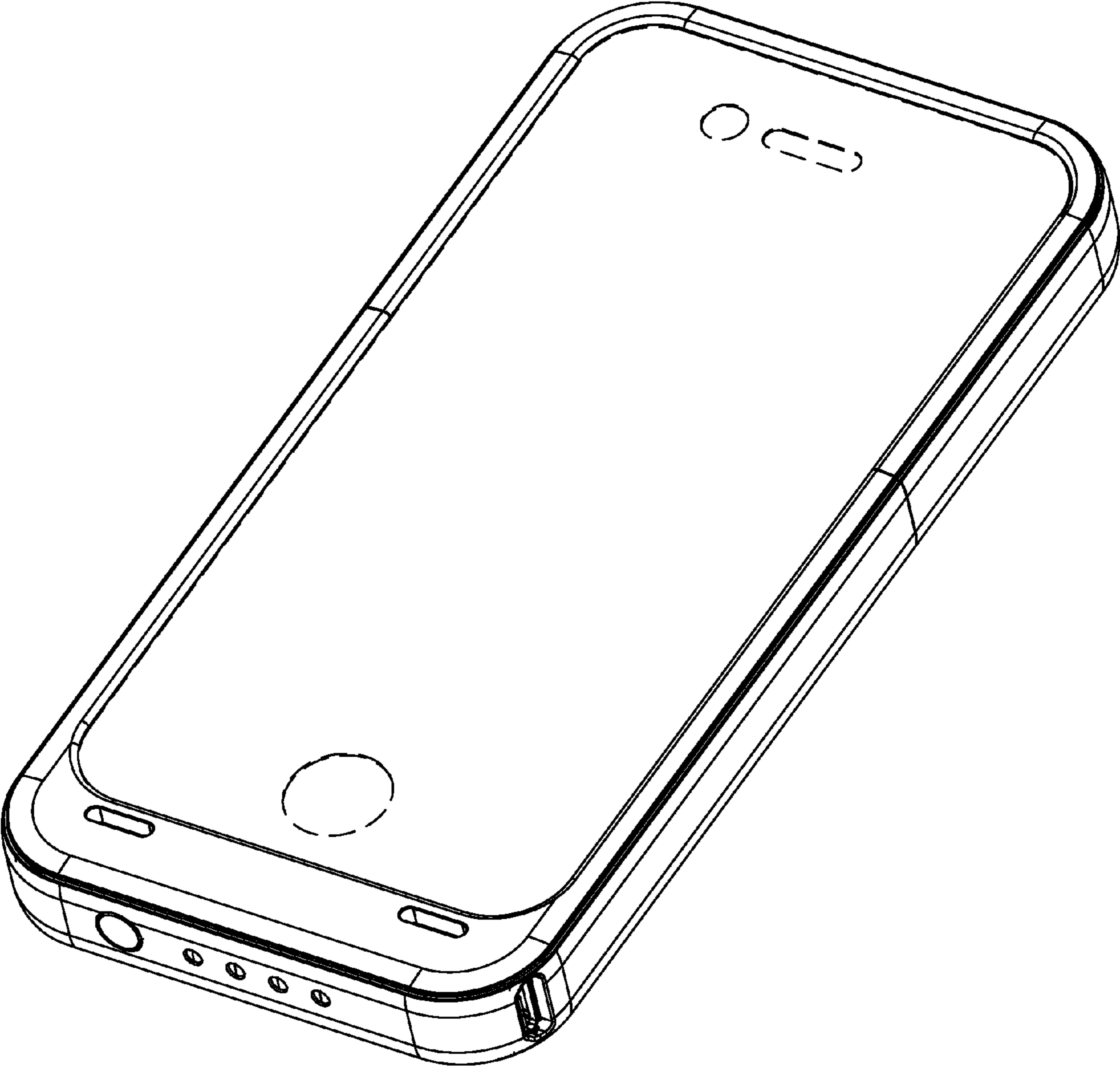

FIGURE 6



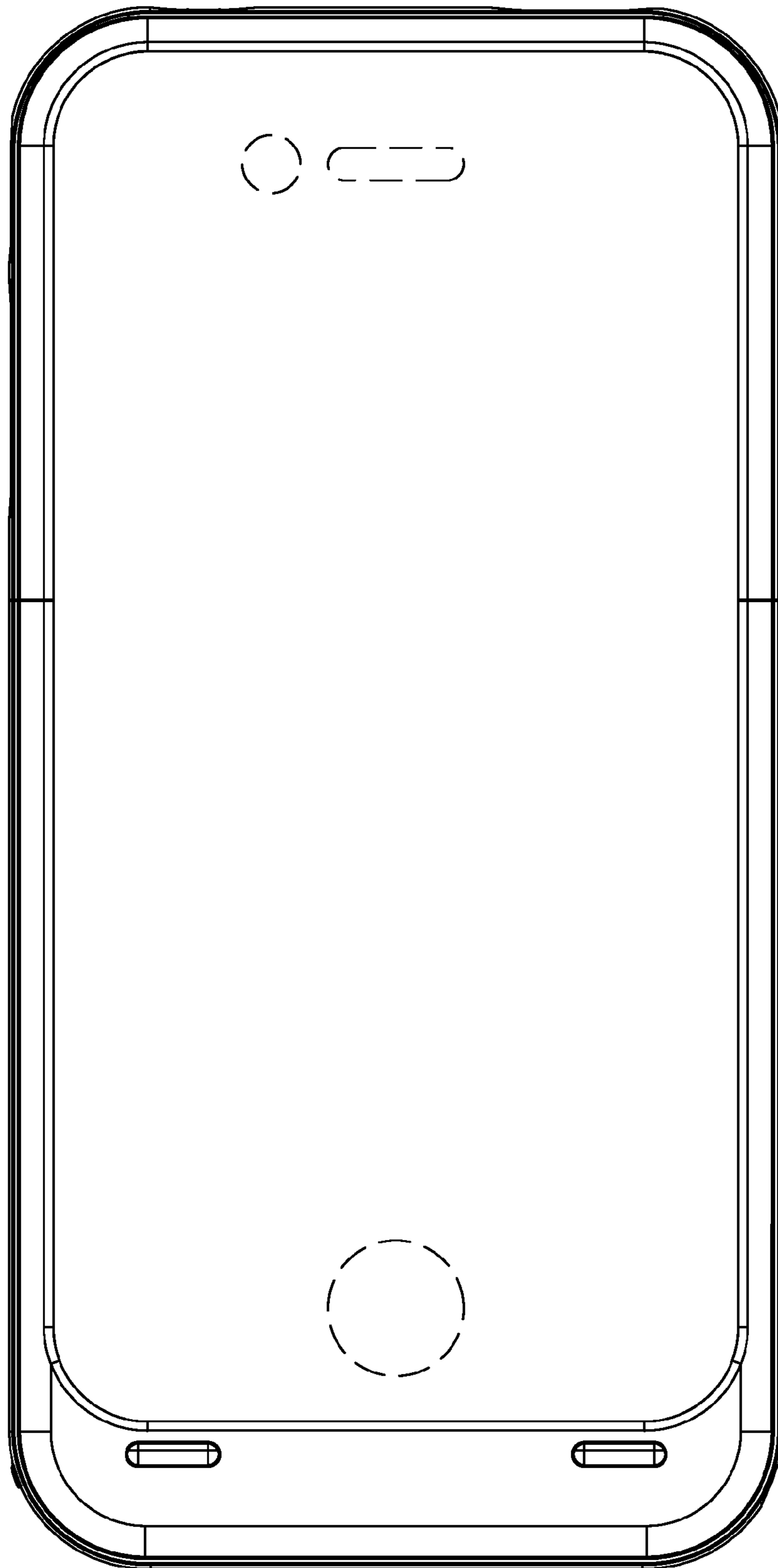

FIGURE 7

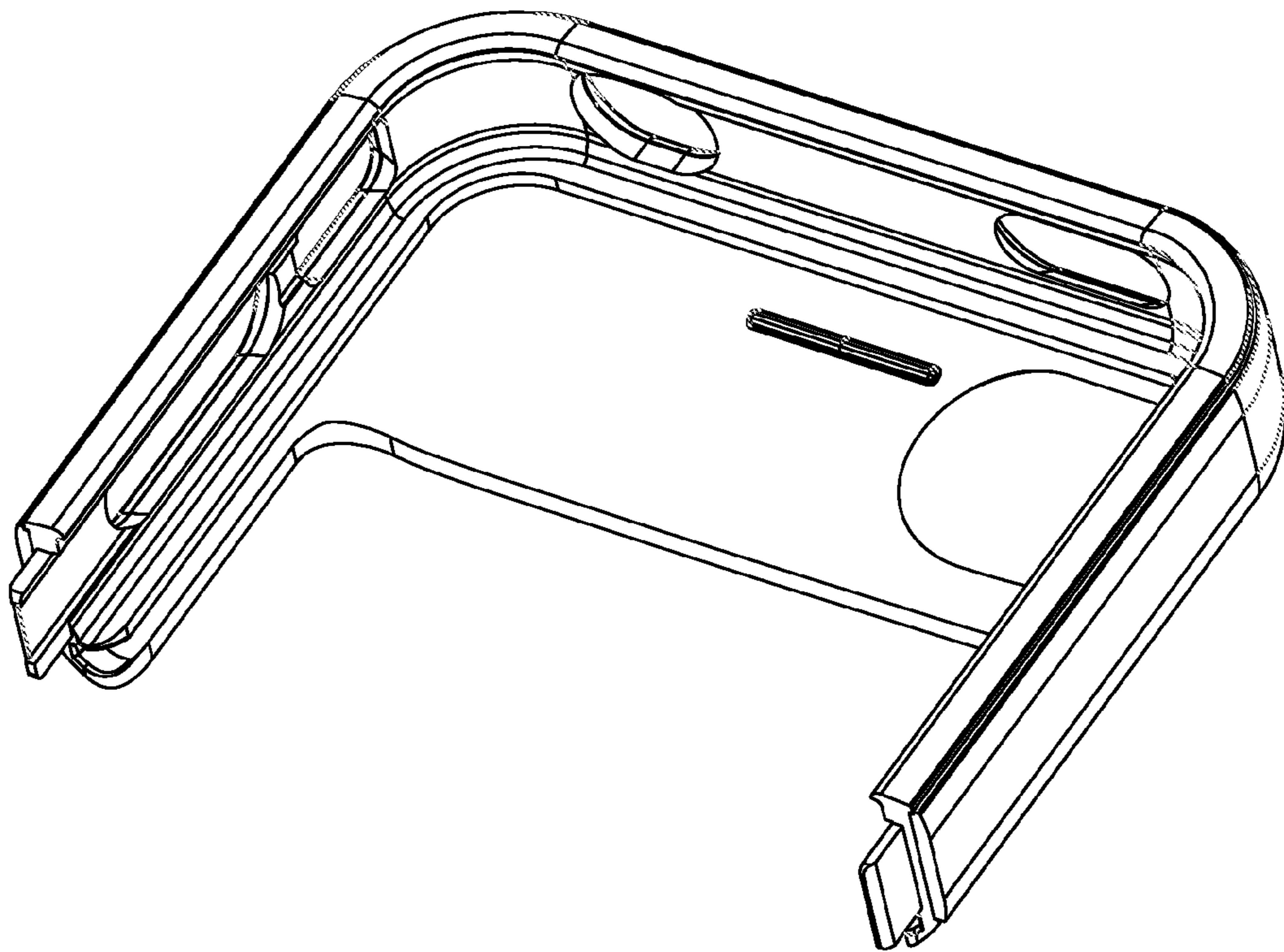

FIGURE 8

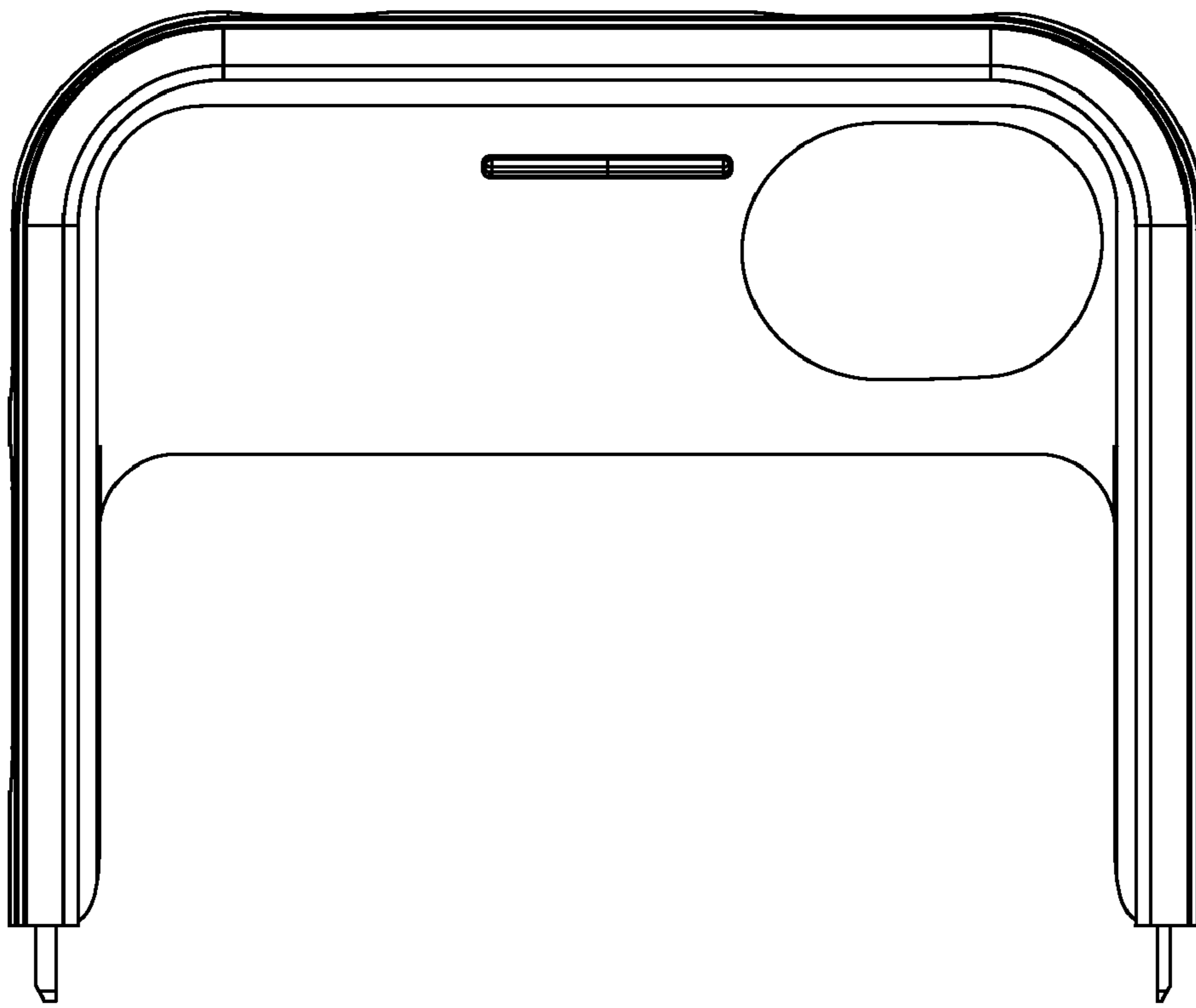

FIGURE 9

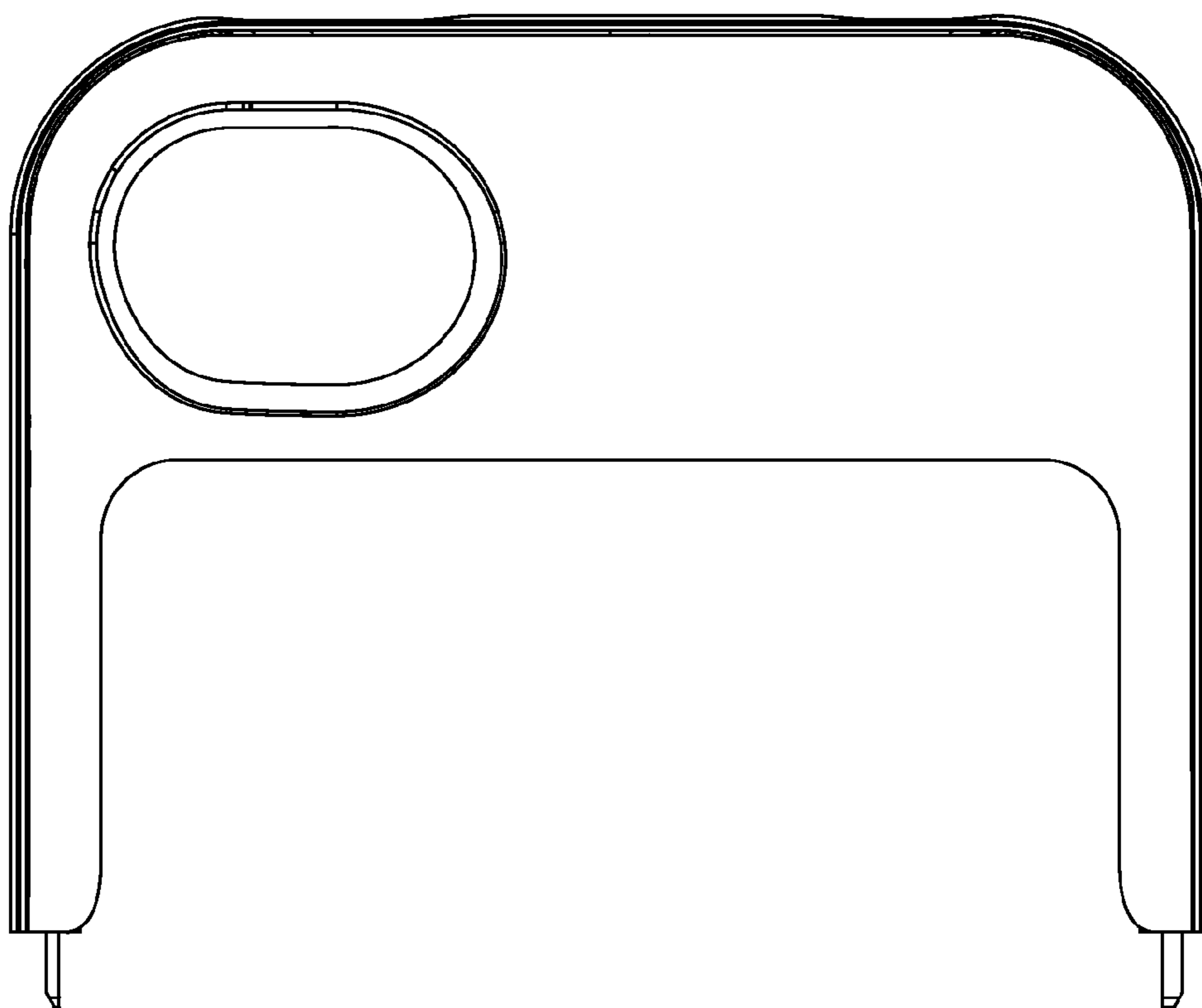

FIGURE 10

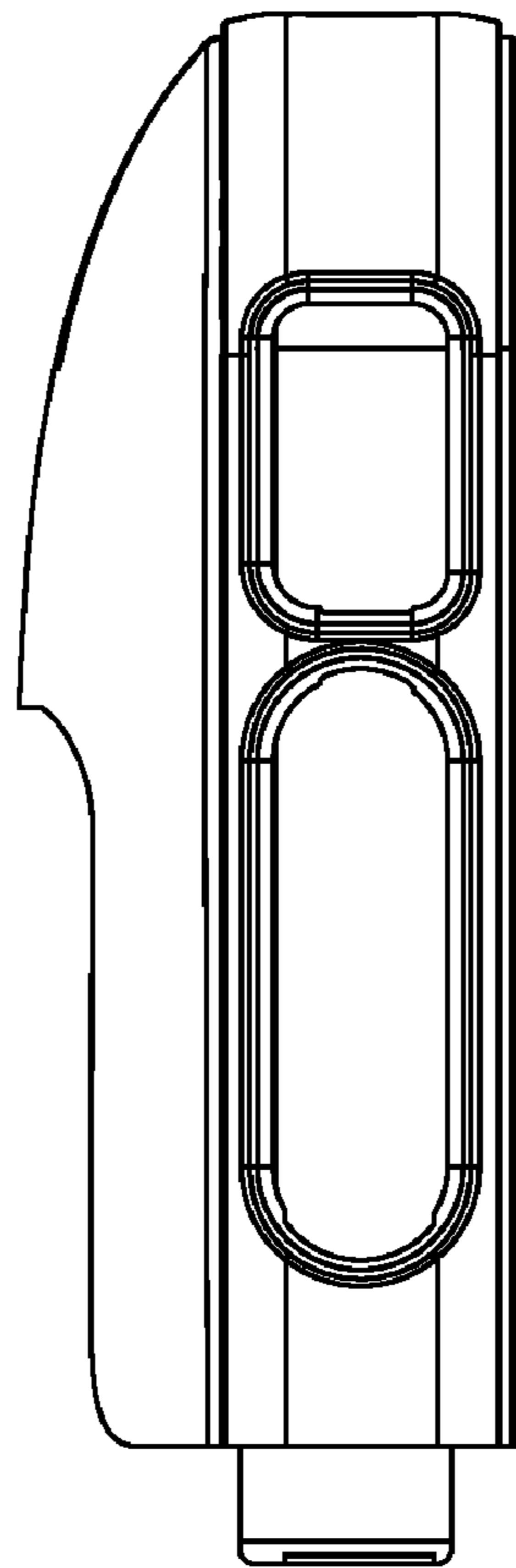

FIGURE 11

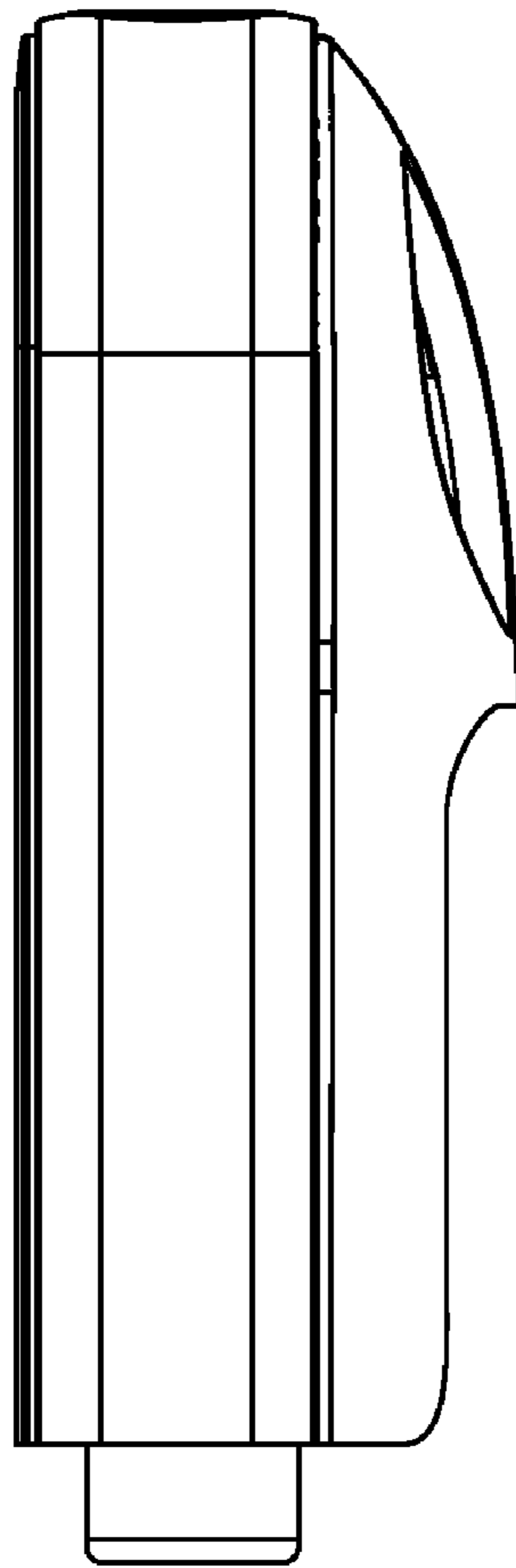

FIGURE 12

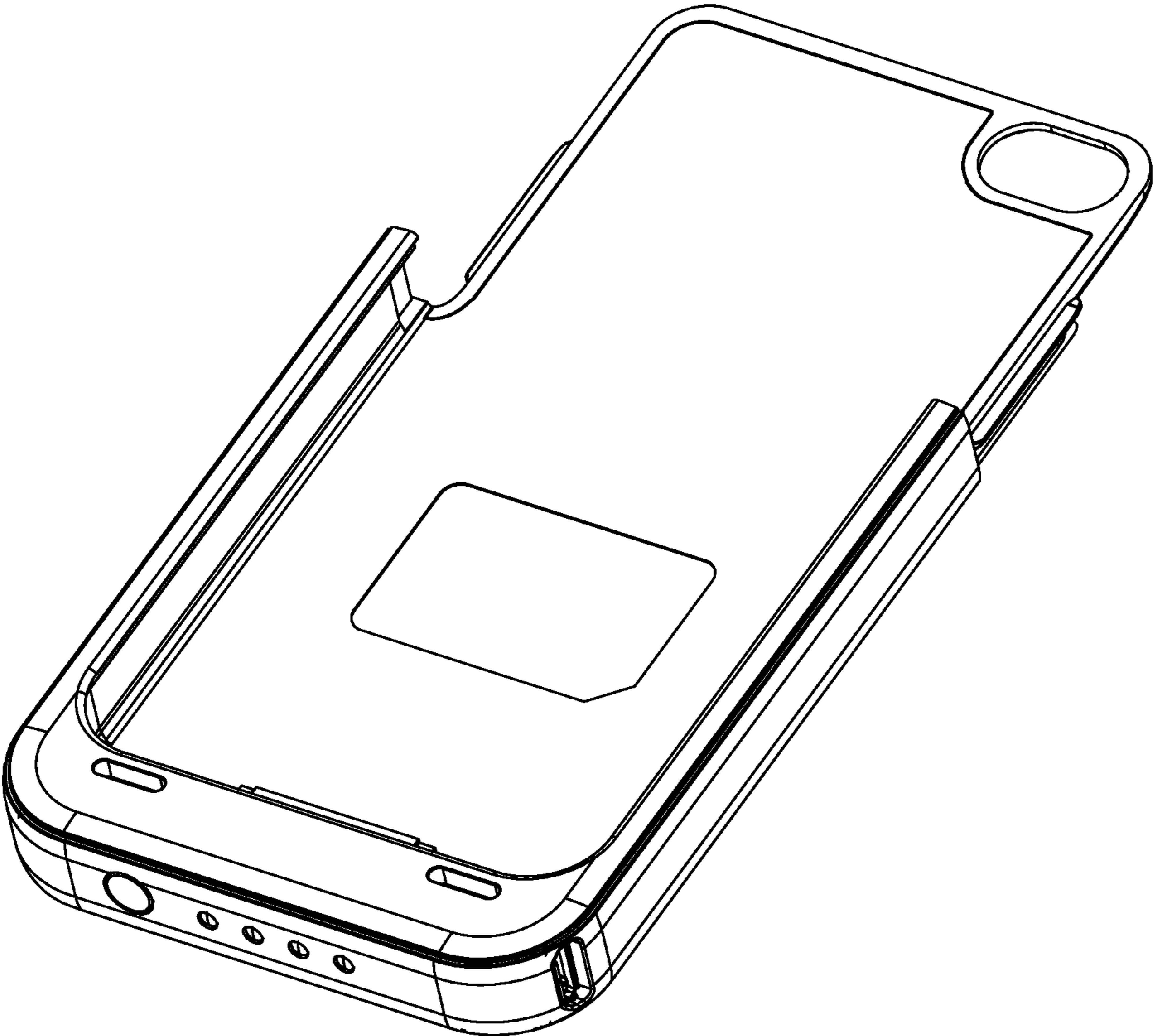

FIGURE 13

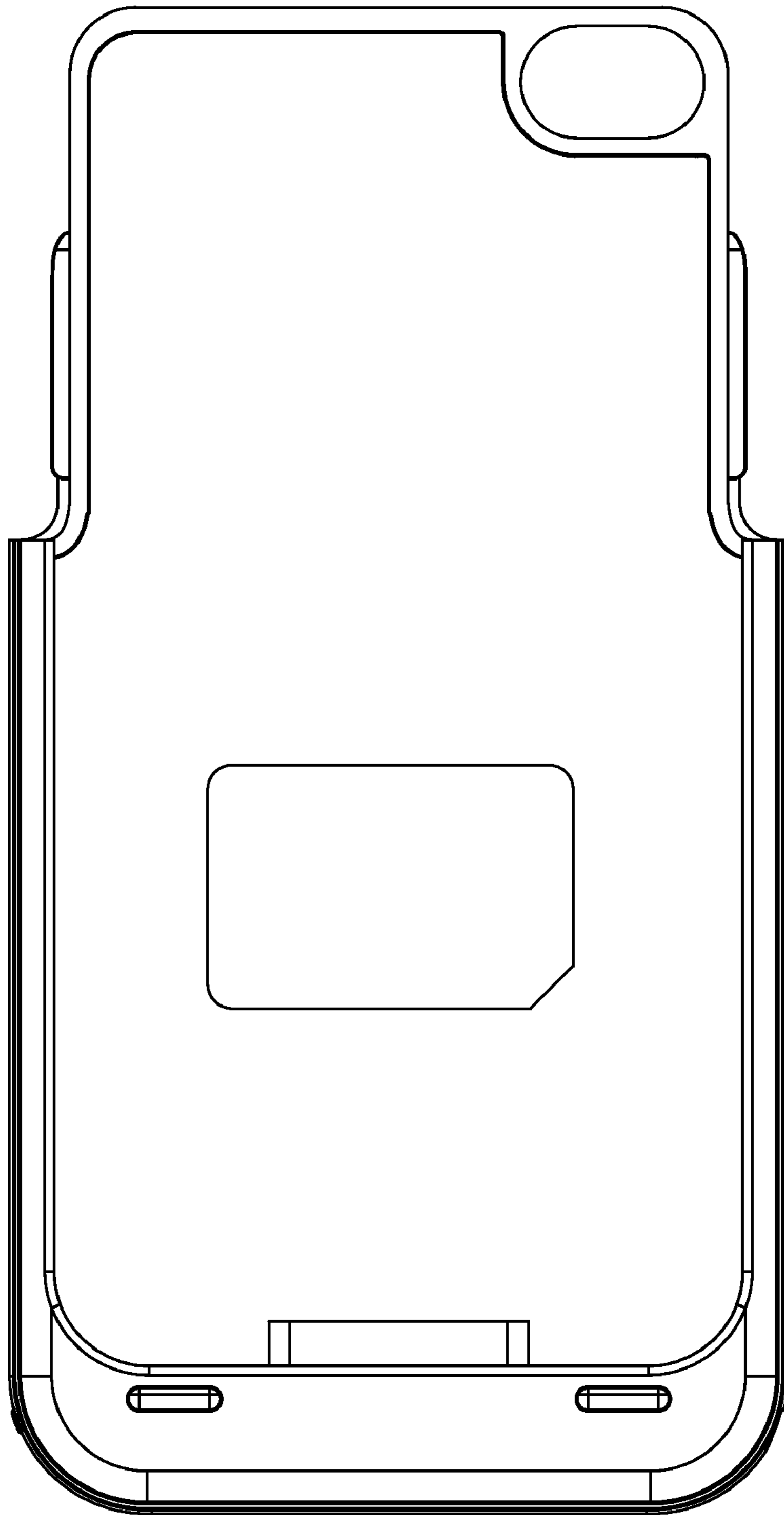

FIGURE 14



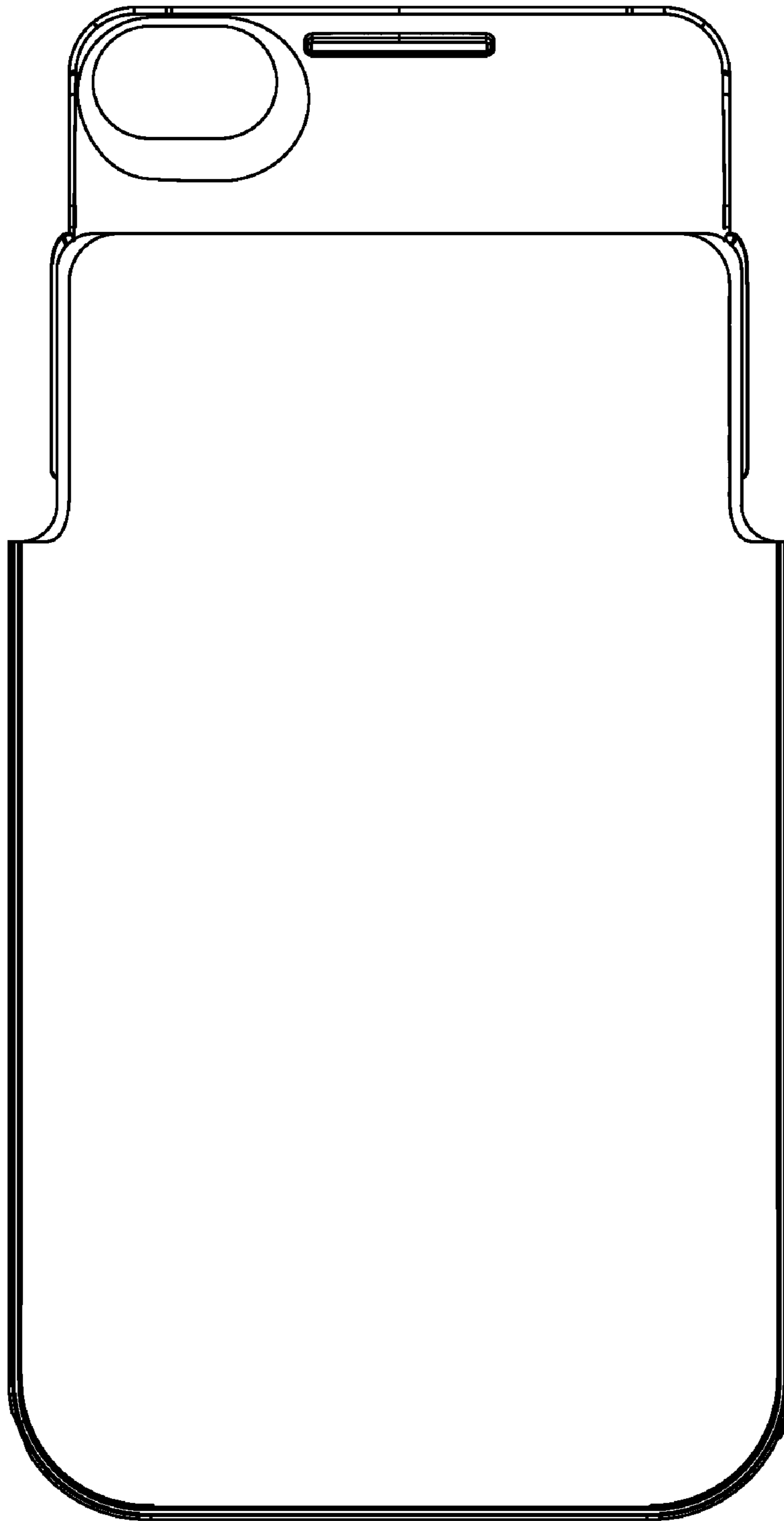

FIGURE 15

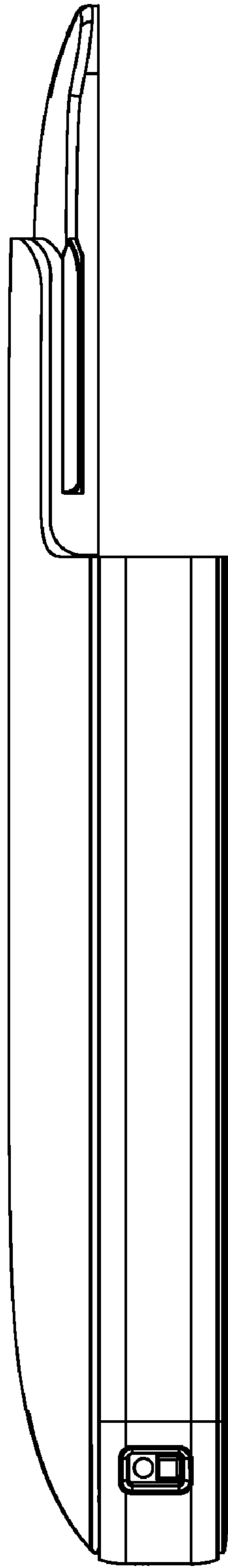

FIGURE 16

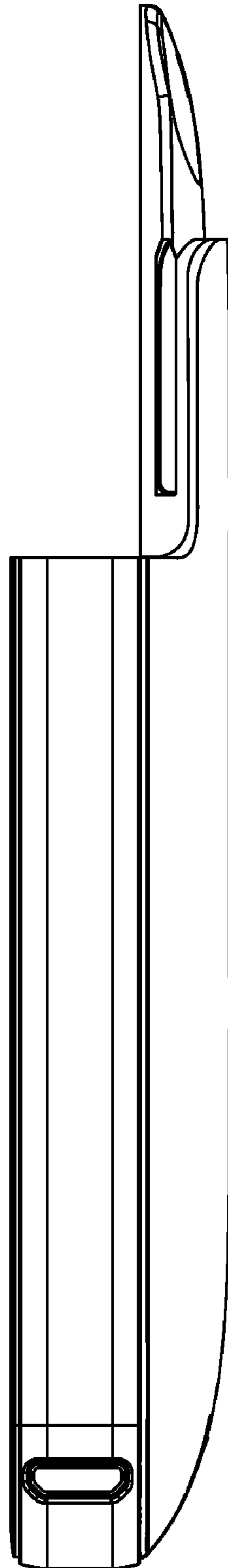

FIGURE 17

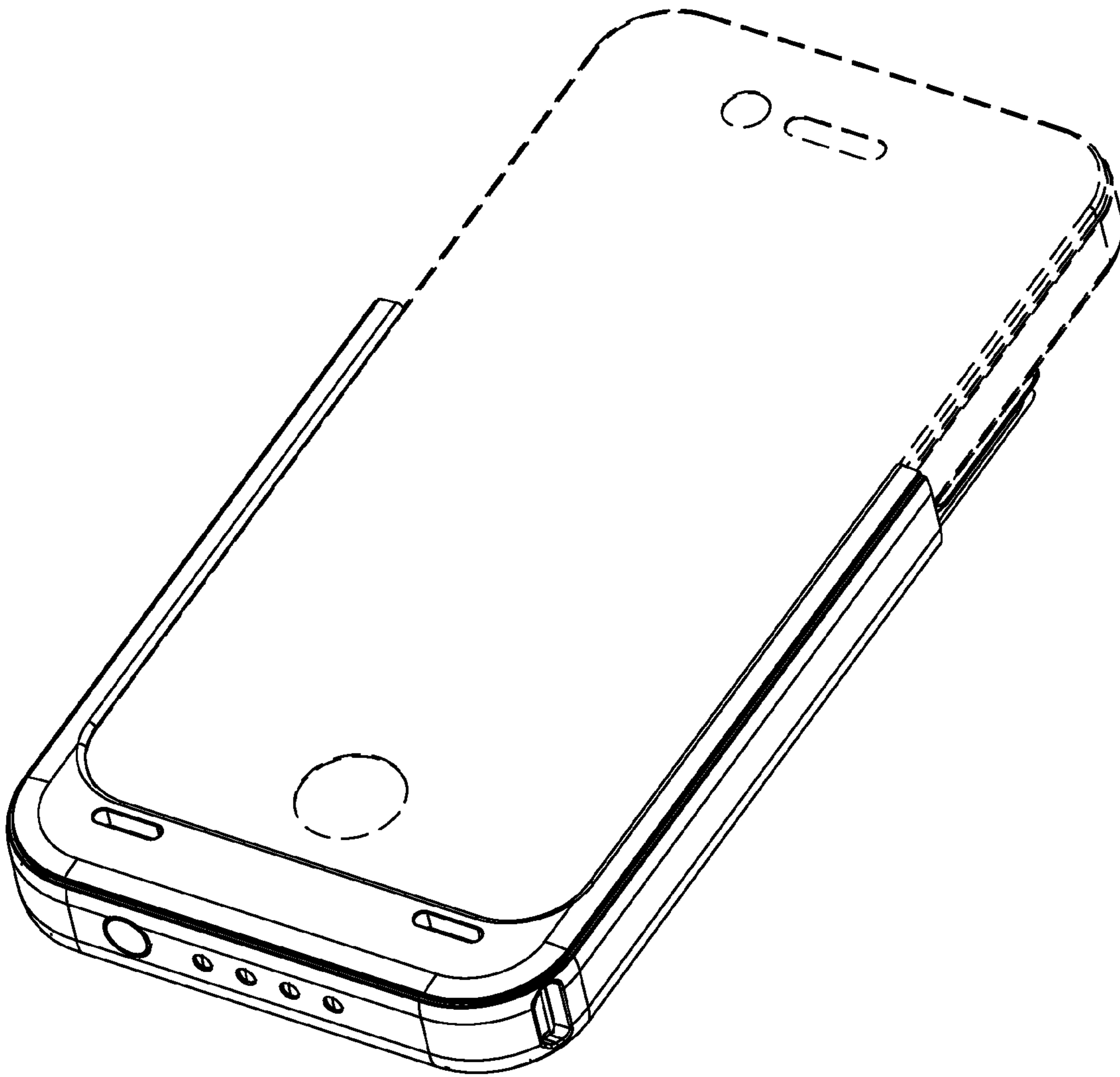

FIGURE 18

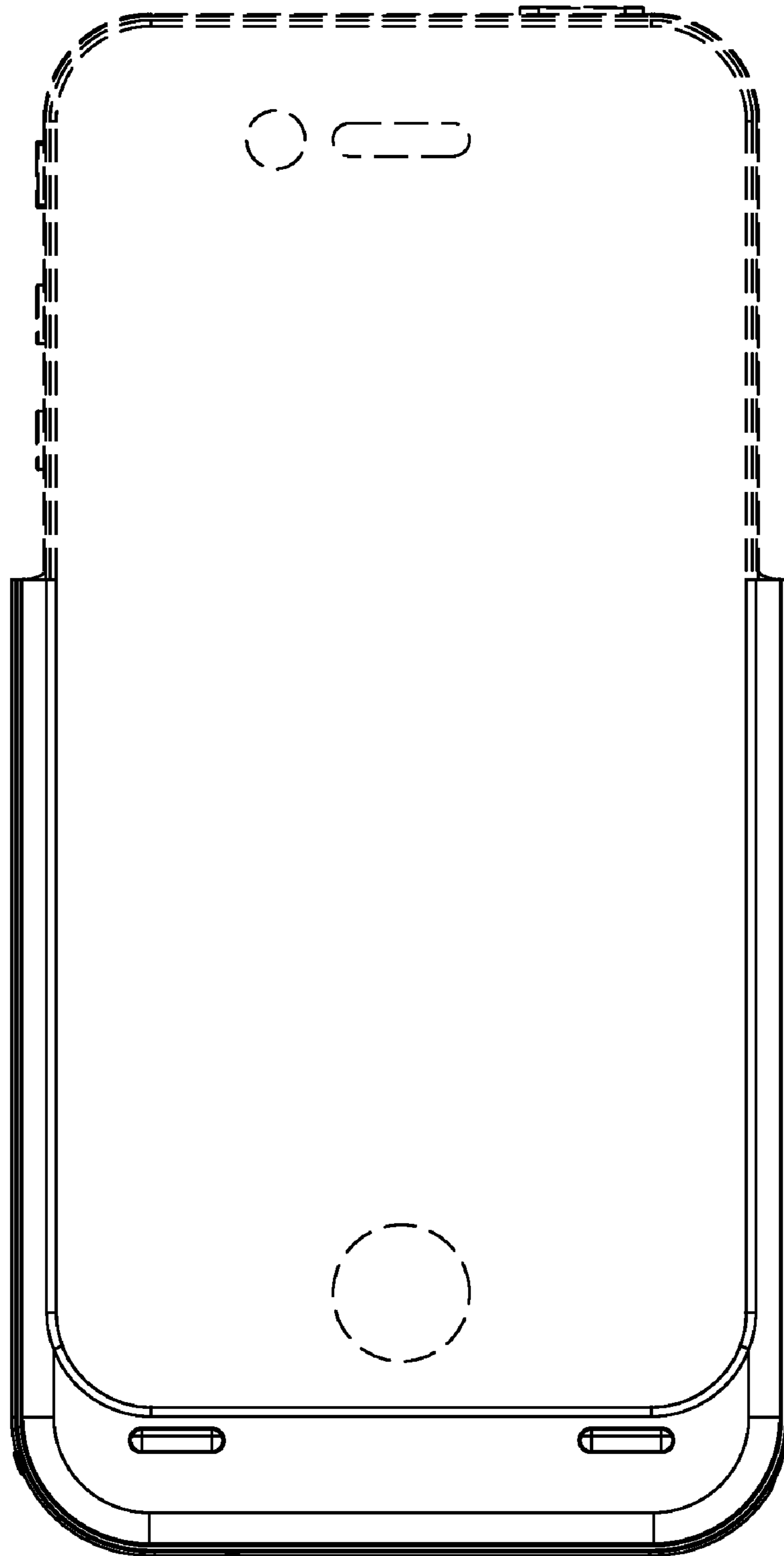

FIGURE 19

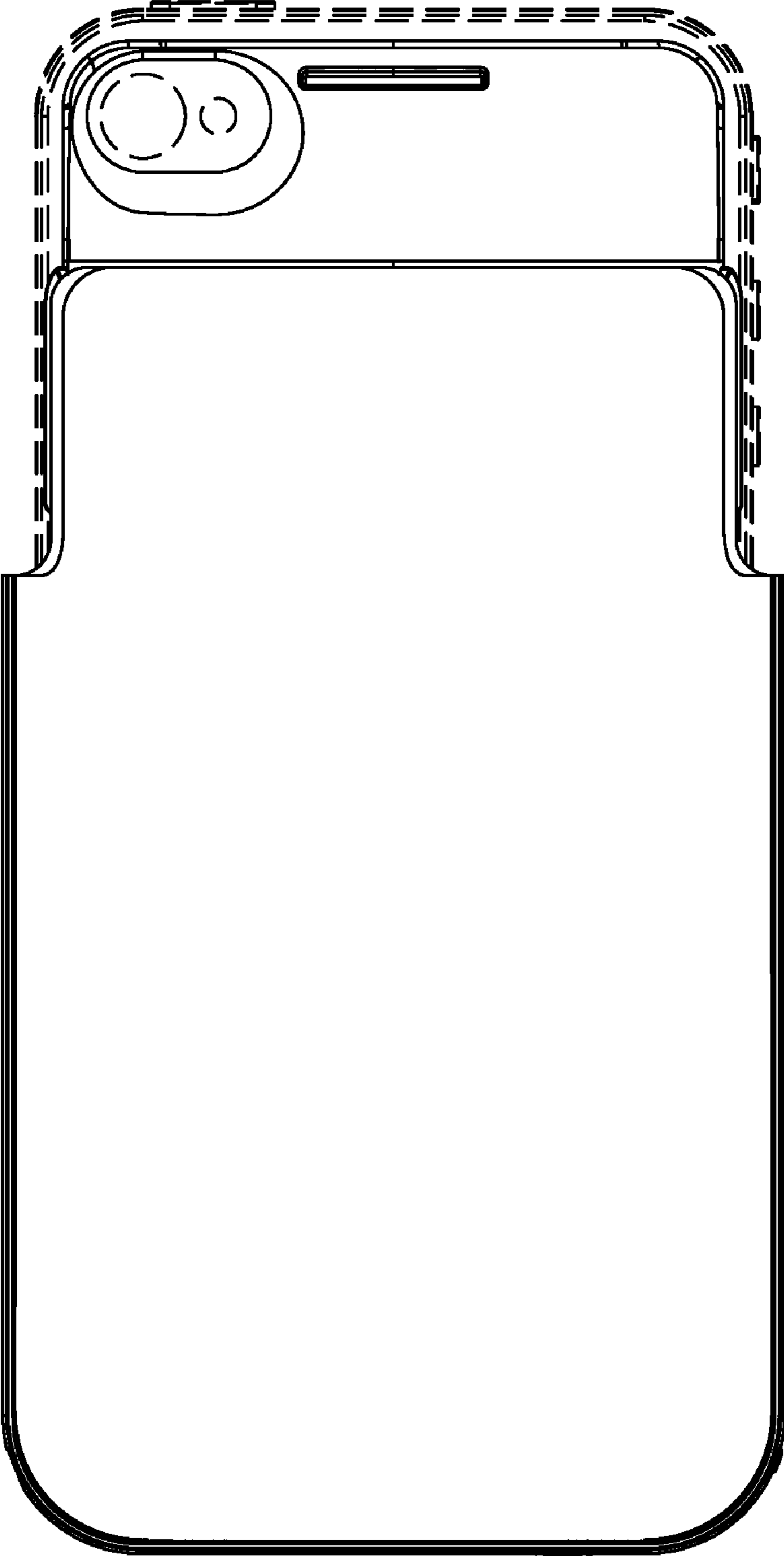

FIGURE 20

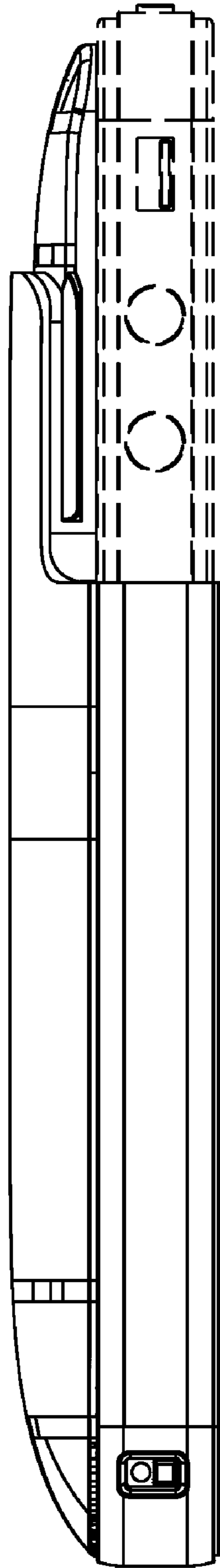

FIGURE 21

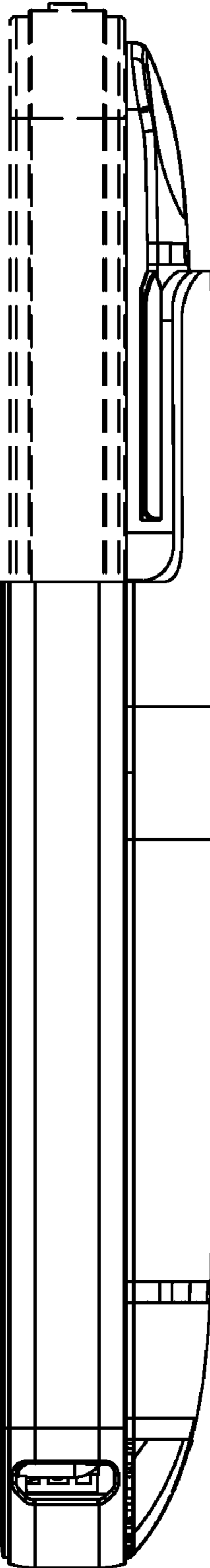

FIGURE 22



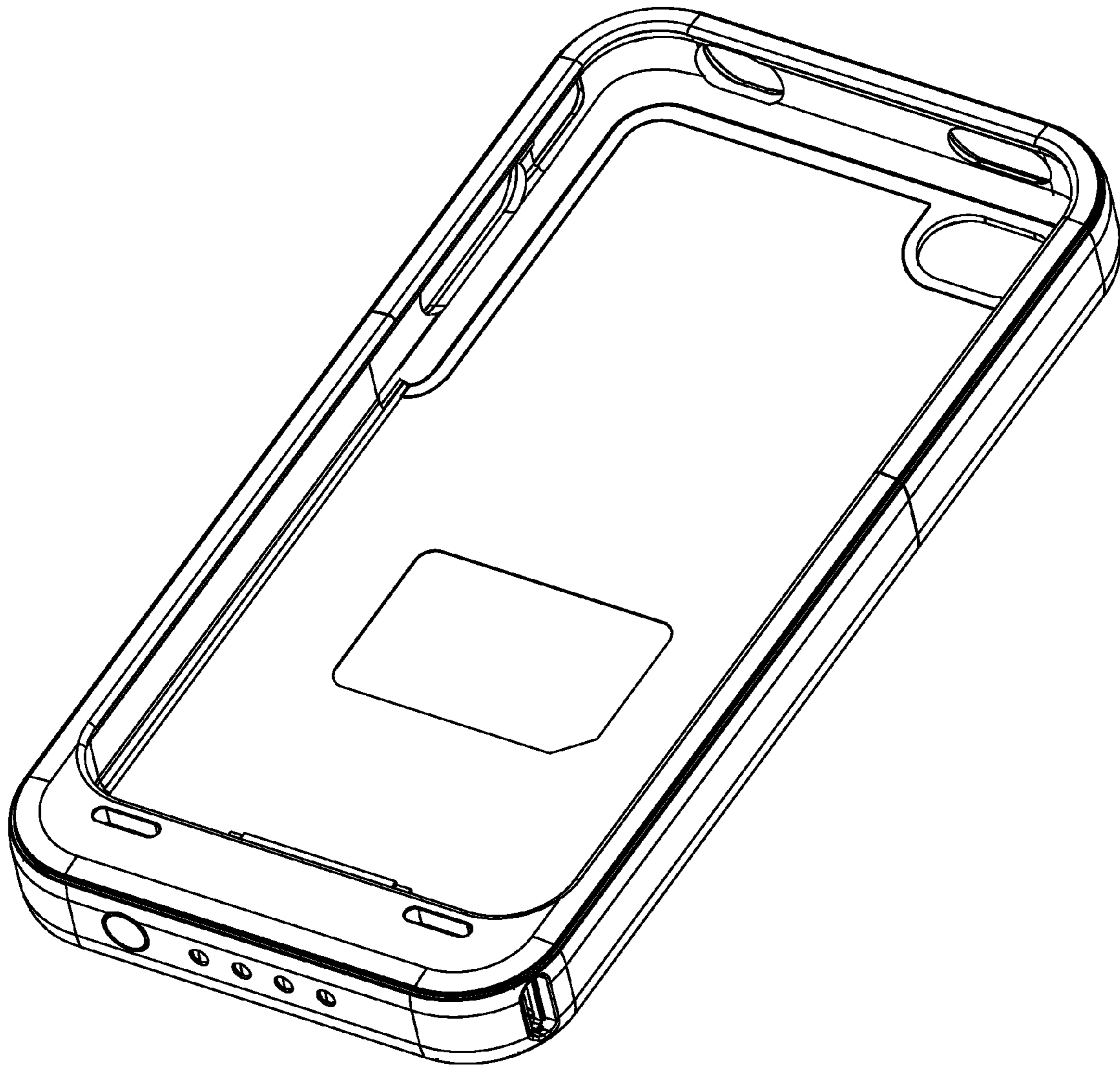

FIGURE 23

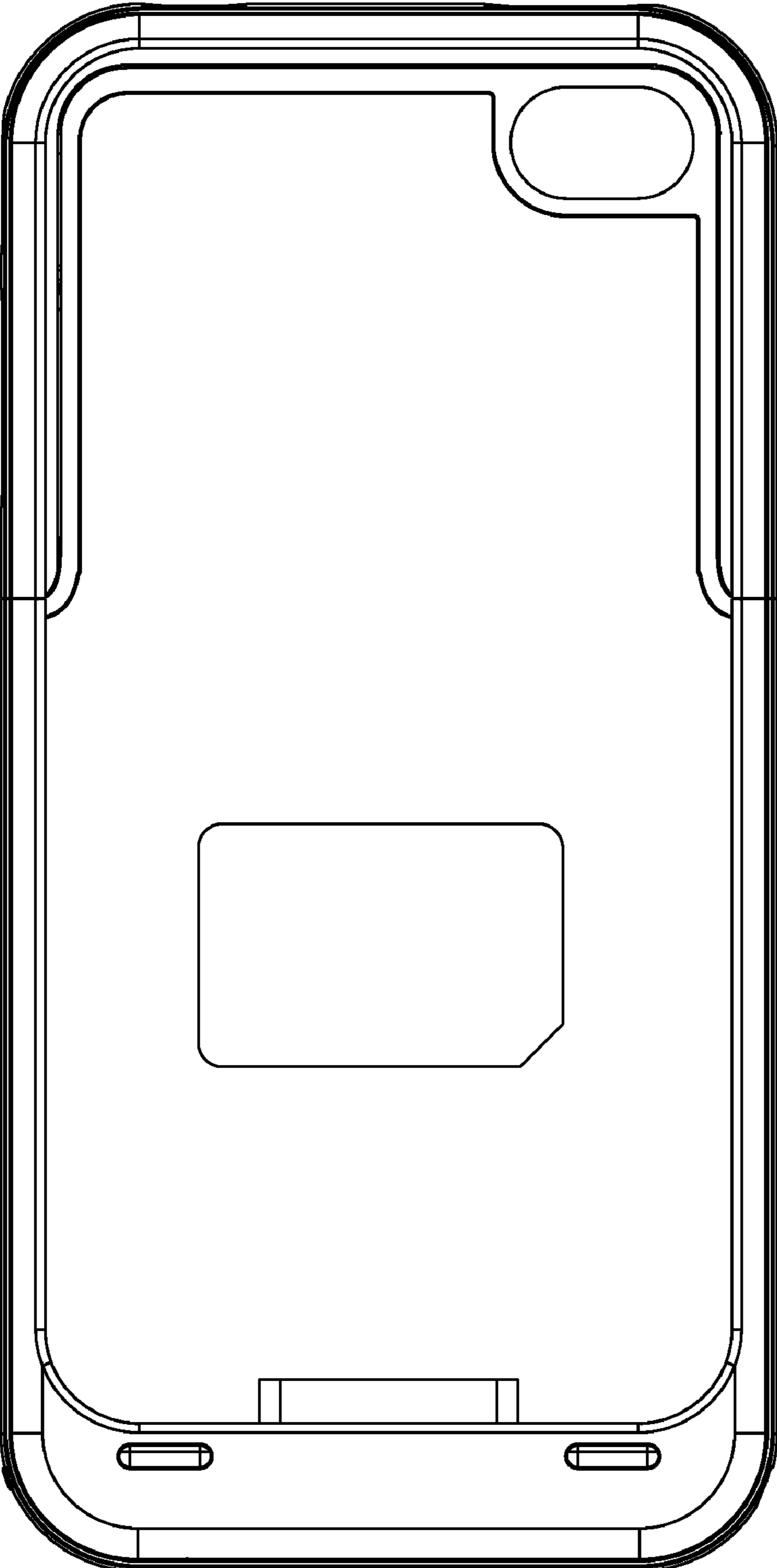

FIGURE 24

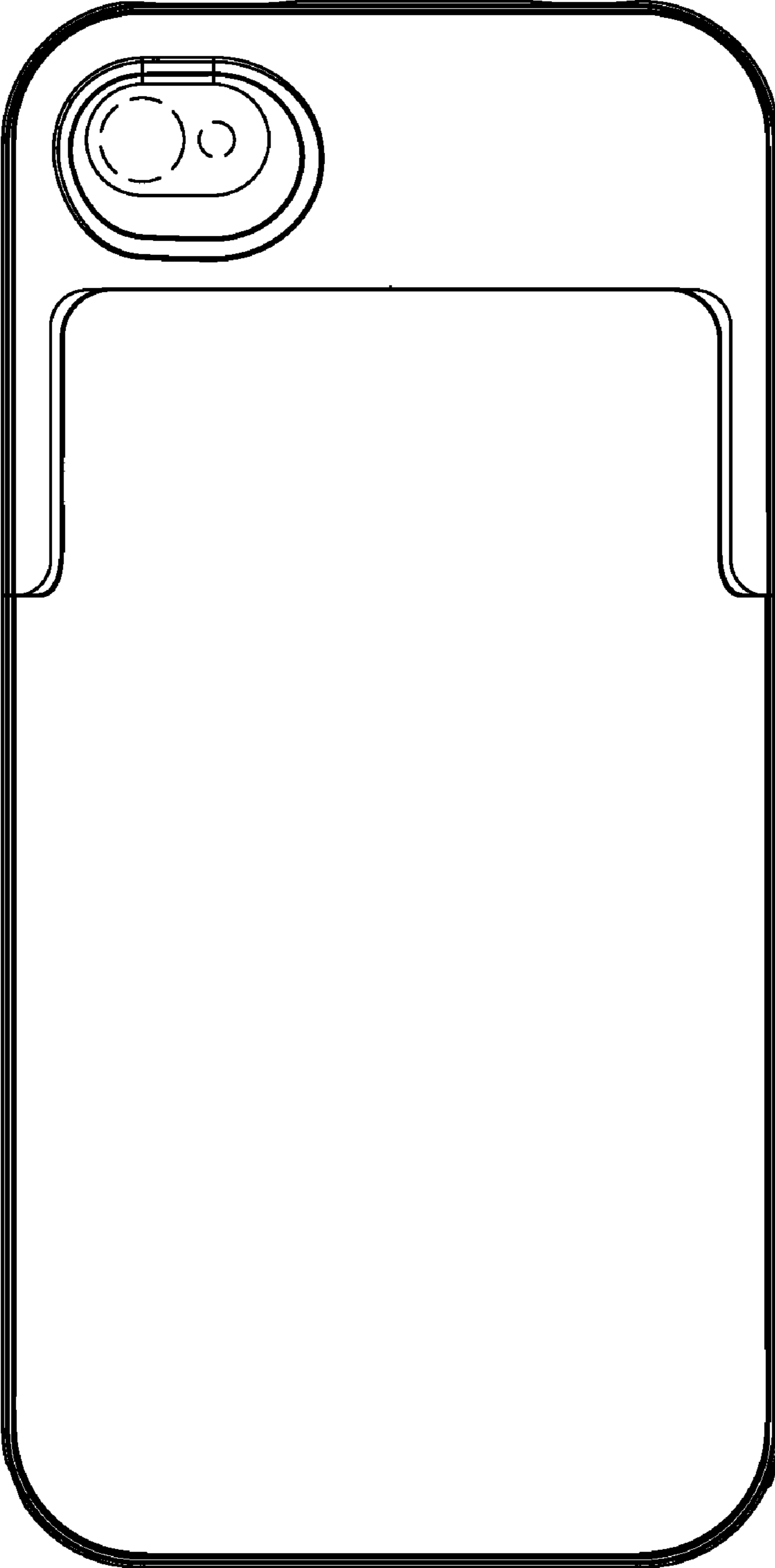

FIGURE 25

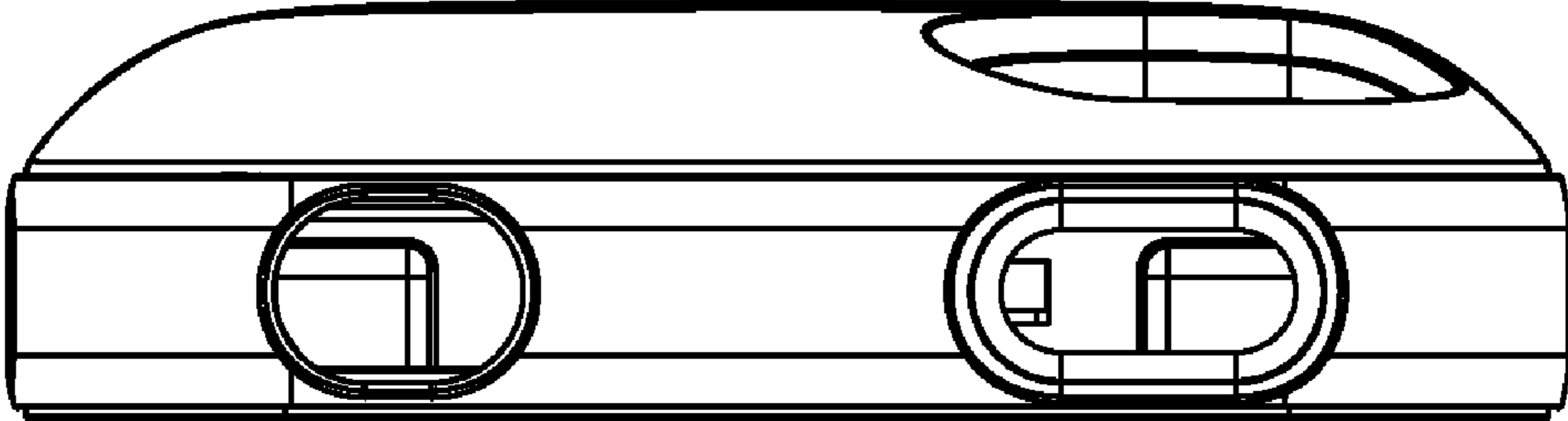

FIGURE 26

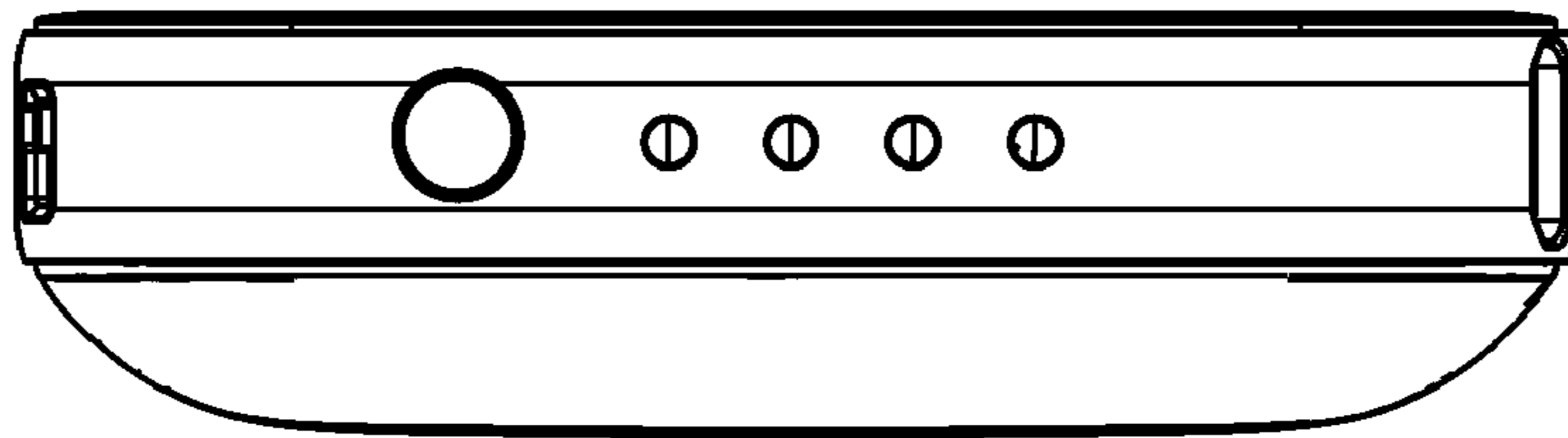

FIGURE 27

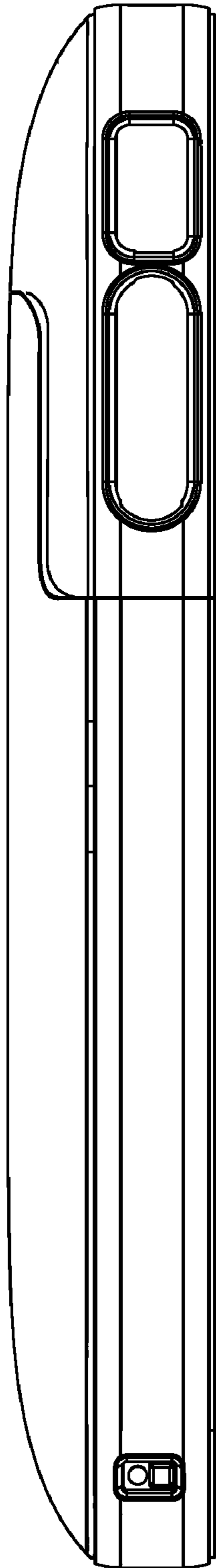

FIGURE 28

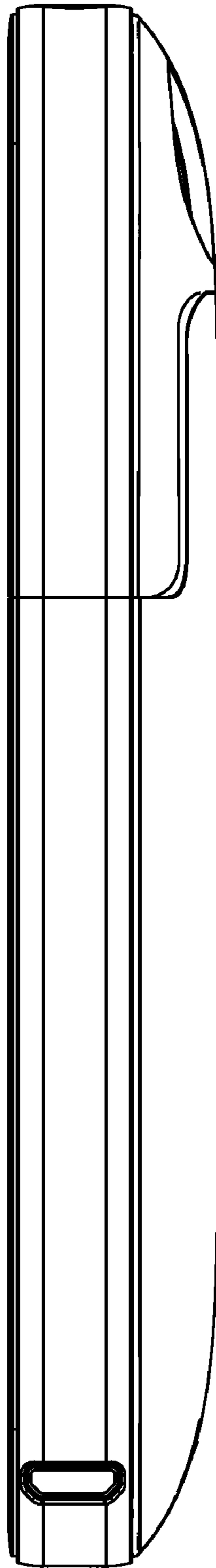

FIGURE 29