



US00D653167S

(12) **United States Design Patent**
Dunn

(10) **Patent No.:** **US D653,167 S**
(45) **Date of Patent:** **** Jan. 31, 2012**

(54) **FOOTBALL HELMET DISPLAY HOLDER FOR A CORD**

(76) Inventor: **Scott E. Dunn**, Atlanta, GA (US)

(**) Term: **14 Years**

(21) Appl. No.: **29/394,595**

(22) Filed: **Jun. 18, 2011**

(51) **LOC (9) Cl.** **11-02**

(52) **U.S. Cl.** **D11/184**

(58) **Field of Classification Search** D11/184;
D8/105, 107, 333, 349, 354, 356, 358, 367,
D8/373, 382, 383, 394-396; D23/261; D26/38;
24/197, 561; 174/153 G; 242/400.1, 405.1,
242/405.2, 600, 916; 248/65, 74.1-74.4,
248/214, 215, 229.26, 201, 302, 204, 316.7,
248/316.8; 439/501; D34/38; 108/57.52
See application file for complete search history.

(56) **References Cited**

U.S. PATENT DOCUMENTS

1,195,276 A 8/1916 Seaman
(Continued)

FOREIGN PATENT DOCUMENTS

WO 2010132567 A1 11/2010

OTHER PUBLICATIONS

<http://www.thecablelabelco.co.uk/buy.php> (Buy Cable Bug Labels in Bags) (First access Nov. 26, 2010).

(Continued)

Primary Examiner — Holly Baynham
Assistant Examiner — Michelle E Wilson

(74) *Attorney, Agent, or Firm* — Ballard Spahr LLP

(57) **CLAIM**

The ornamental design for a football helmet display holder for a cord, as shown and described.

DESCRIPTION

FIG. 1 is a perspective view of one embodiment of a football helmet display holder for a cord of the present invention; FIG. 2 is a front elevational view of the football helmet display holder for a cord of FIG. 1; FIG. 3 is a rear elevational view of the football helmet display holder for a cord of FIG. 1; FIG. 4 is a left side elevational view of the football helmet display holder for a cord of FIG. 1; FIG. 5 is a right side elevational view of the football helmet display holder for a cord of FIG. 1; FIG. 6 is a top elevational view of the football helmet display holder for a cord of FIG. 1; FIG. 7 is a bottom elevational view of the football helmet display holder for a cord of FIG. 1; FIG. 8 is a perspective view of the football helmet display holder for a cord of FIG. 1, showing a representative design in broken lines on the front side of the device; FIG. 9 is a front elevational view of the football helmet display holder for a cord of FIG. 8; FIG. 10 is a rear elevational view of the football helmet display holder for a cord of FIG. 8; FIG. 11 is a left side elevational view of the football helmet display holder for a cord of FIG. 8; FIG. 12 is a right side elevational view of the football helmet display holder for a cord of FIG. 8; FIG. 13 is a top elevational view of the football helmet display holder for a cord of FIG. 8; and, FIG. 14 is a bottom elevational view of the football helmet display holder for a cord of FIG. 8. The broken lines shown in FIGS. 8, 9 and 11-13 are for illustrative purposes only and form no part of the claimed design.

1 Claim, 10 Drawing Sheets

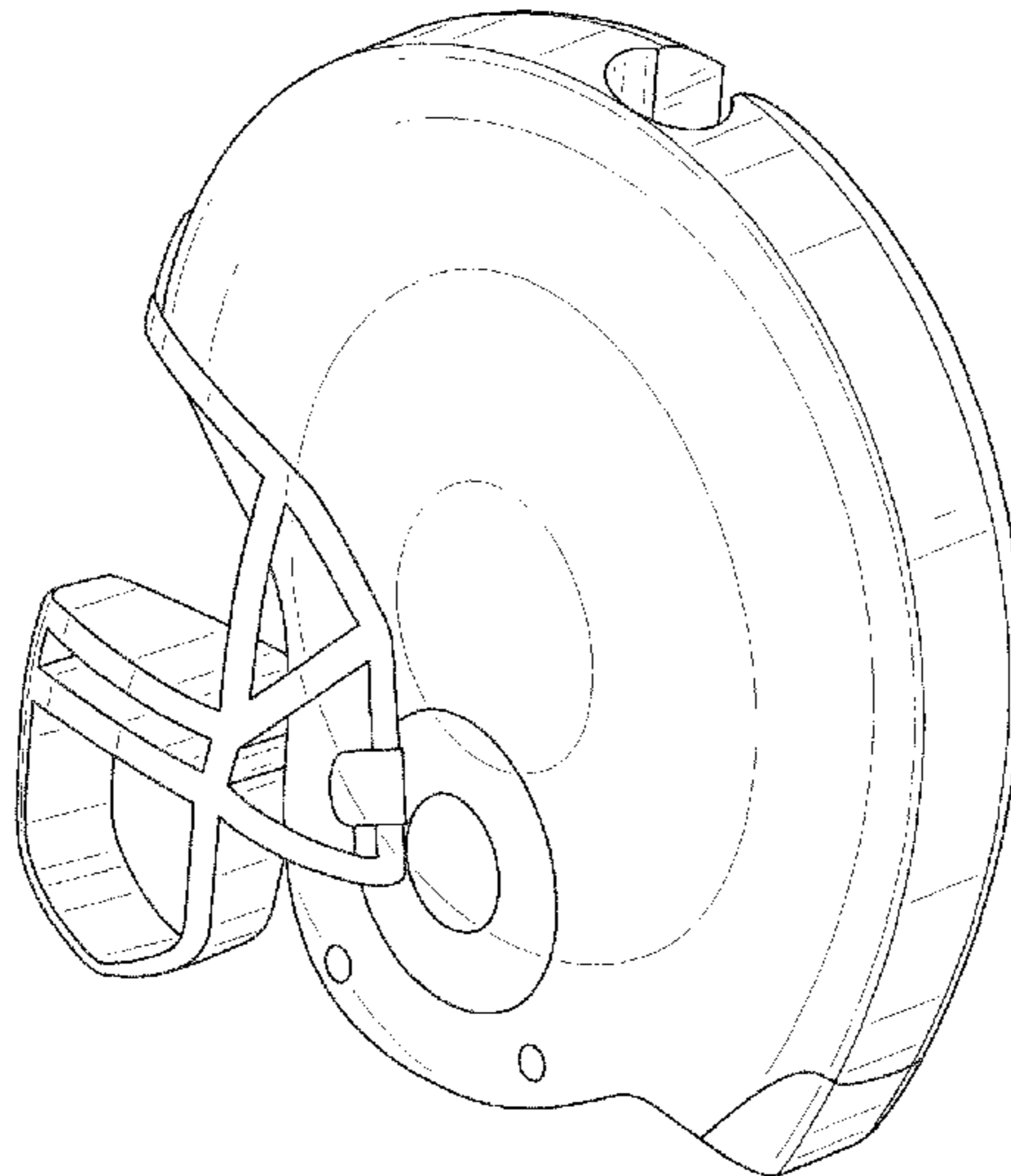

US D653,167 S

Page 2

U.S. PATENT DOCUMENTS

1,388,219 A 8/1921 Thompson
1,832,318 A 11/1931 Myers
3,203,700 A 8/1965 Antonious
3,576,304 A * 4/1971 Gillemot et al. 248/74.2
3,696,920 A * 10/1972 Lahay 206/370
3,772,809 A 11/1973 Schneller
4,004,362 A 1/1977 Barbieri
4,011,673 A 3/1977 Levine
4,261,121 A 4/1981 Coon
D275,174 S * 8/1984 Rolli D8/356
4,539,767 A 9/1985 Jaffe
D285,044 S * 8/1986 Mockett D8/354
D289,138 S * 4/1987 Nead D8/356
4,656,767 A 4/1987 Tarrant
D289,732 S * 5/1987 Jason D8/356
D293,766 S * 1/1988 Lamb D8/356
4,856,214 A 8/1989 Machen
D308,011 S * 5/1990 Norris D8/356
D325,400 S 4/1992 Wolff
D358,615 S 5/1995 Cline
D388,833 S 1/1998 Wilson
D390,066 S * 2/1998 Watkins et al. D7/633
5,933,995 A 8/1999 Gorbach
5,971,436 A 10/1999 Cox
5,979,028 A 11/1999 Hicks et al.
D421,773 S 3/2000 Yashar
D436,518 S * 1/2001 Matsubara D8/356
6,301,756 B1 10/2001 Howard
6,332,247 B1 12/2001 Hsich
D454,244 S * 3/2002 Scheff D99/34

D456,692 S * 5/2002 Epstein D8/356
6,392,147 B1 * 5/2002 Hier et al. 174/70 C
D459,194 S 6/2002 Johansson et al.
6,430,782 B1 8/2002 Torres et al.
6,634,528 B2 10/2003 Hurtgam
6,651,362 B2 11/2003 Cavency
D490,692 S * 6/2004 Williams D8/356
D507,508 S * 7/2005 Brownell D11/184
7,073,282 B2 7/2006 Savagian et al.
D542,123 S * 5/2007 Symons D8/356
D568,723 S * 5/2008 Morgan D8/356
D589,328 S * 3/2009 Edge D8/356
7,509,765 B2 3/2009 Flores
D629,286 S * 12/2010 Laskowski D8/356
D629,671 S * 12/2010 Ohori et al. D8/356
D644,501 S * 9/2011 Chen D8/356
2008/0285785 A1 11/2008 Zieg et al.

OTHER PUBLICATIONS

[http:// www.fibernetworktools.com/catalog2.php](http://www.fibernetworktools.com/catalog2.php) (FNT Cables and Assemblies)(First access Nov. 26, 2010).
<http://www.nelcoproducts.com> (Nelco Blank Flag Tie Markets)(First access Nov. 26, 2010).
<http://stickngo.com.au> (Stick'nGo Cables Label)(First access Nov. 26, 2010).
http://www.the_storagestore.com (Computer Cable Flags)(First access Nov. 26, 2010).
<http://www.sunlec.com.au> (Sunlec International Cable Sleeves)(First access Nov. 26, 2010).

* cited by examiner

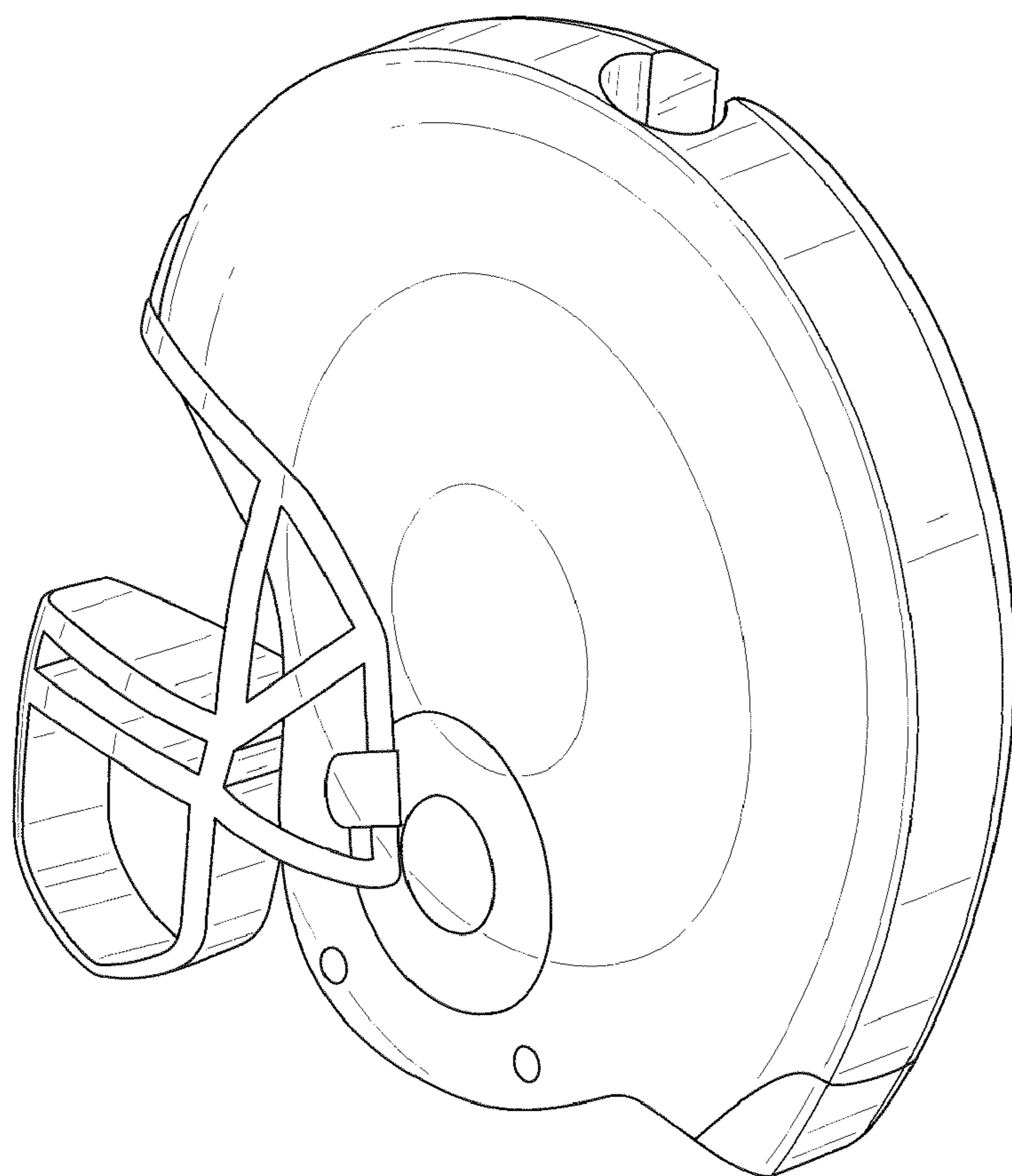

FIG. 1

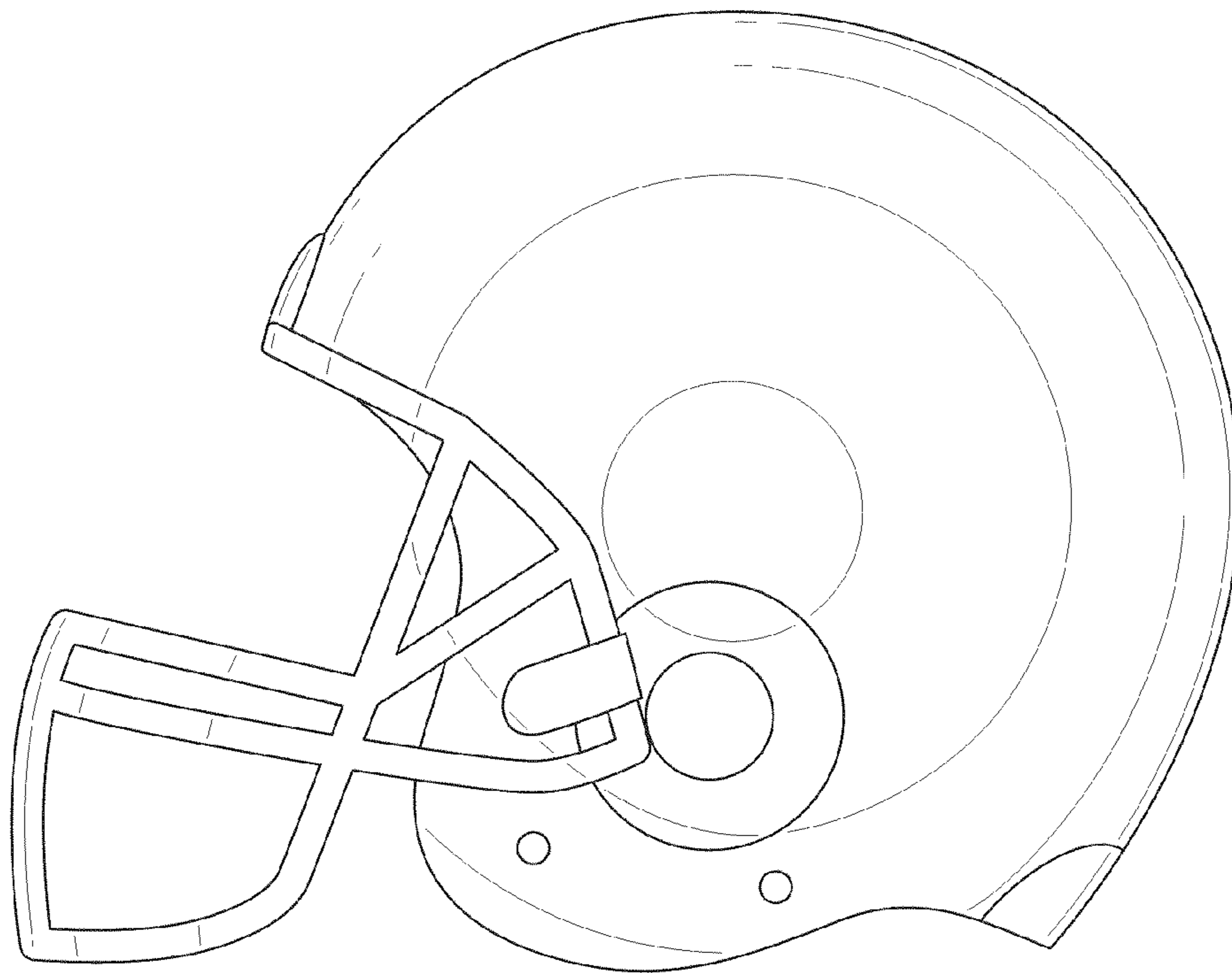

FIG. 2

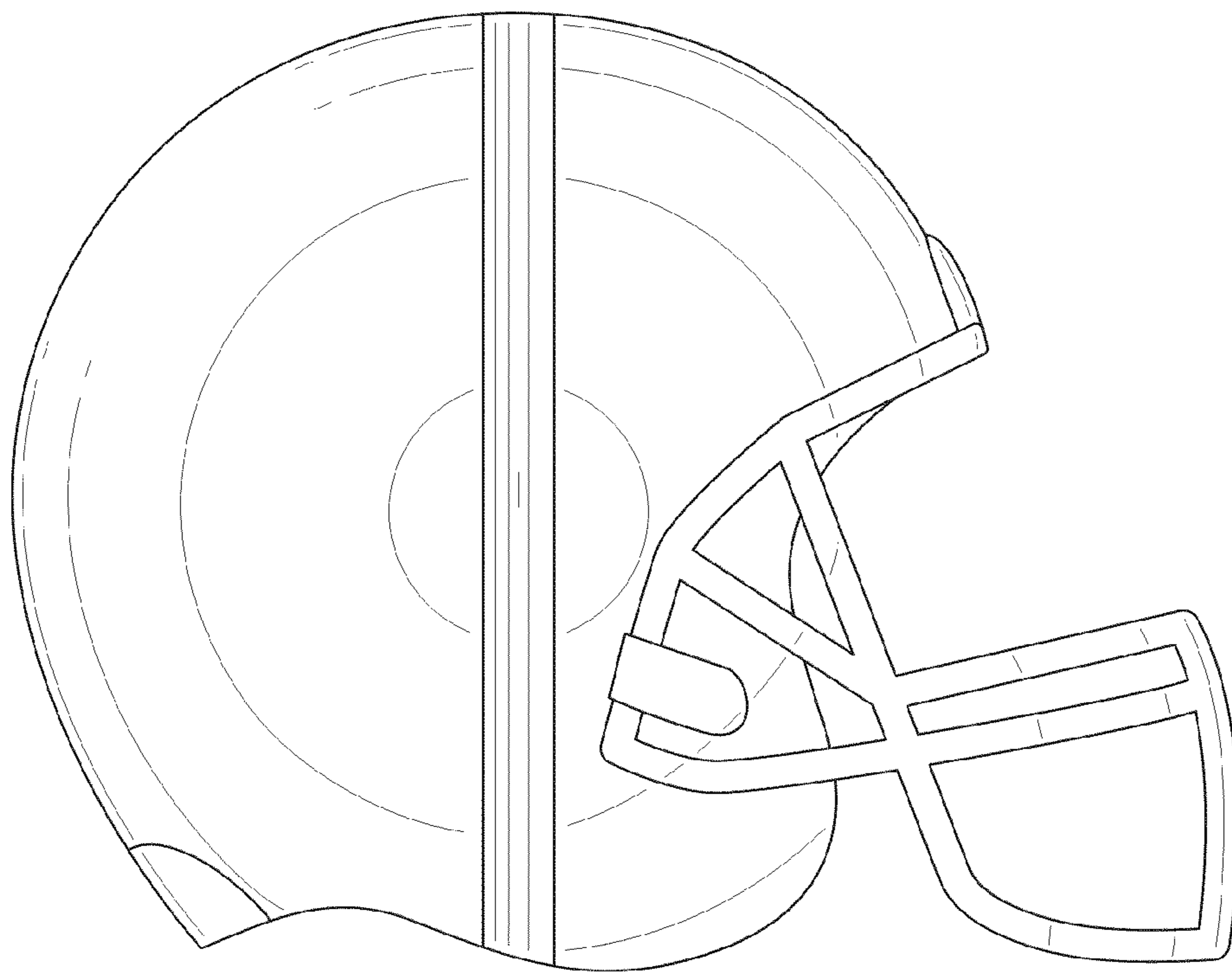

FIG. 3

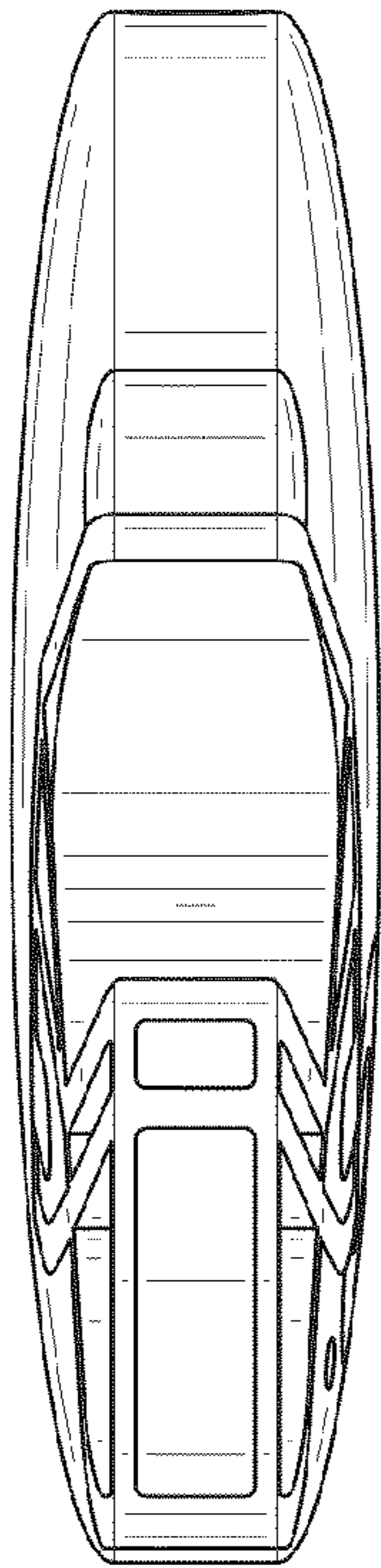

FIG. 4

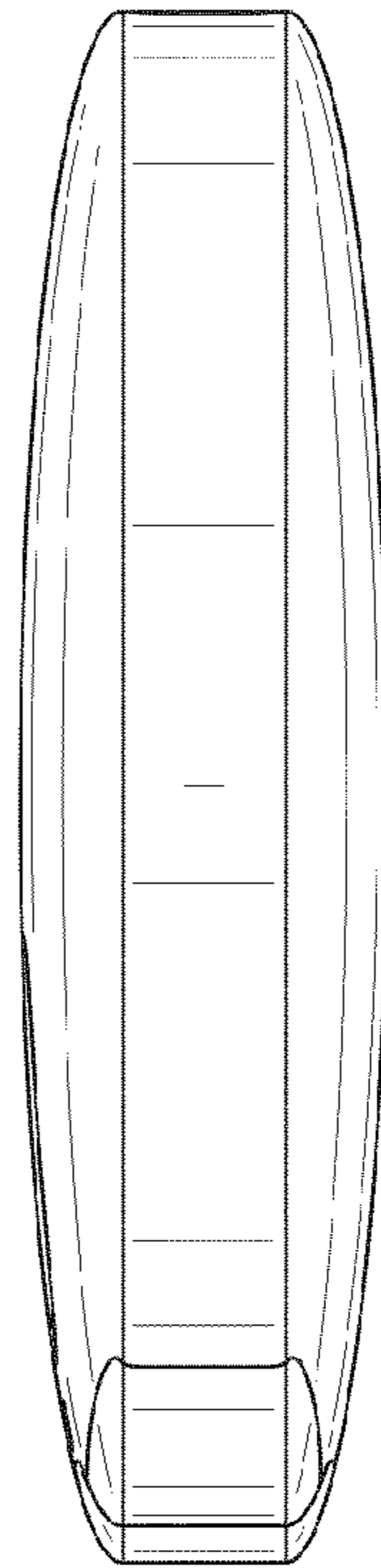

FIG. 5

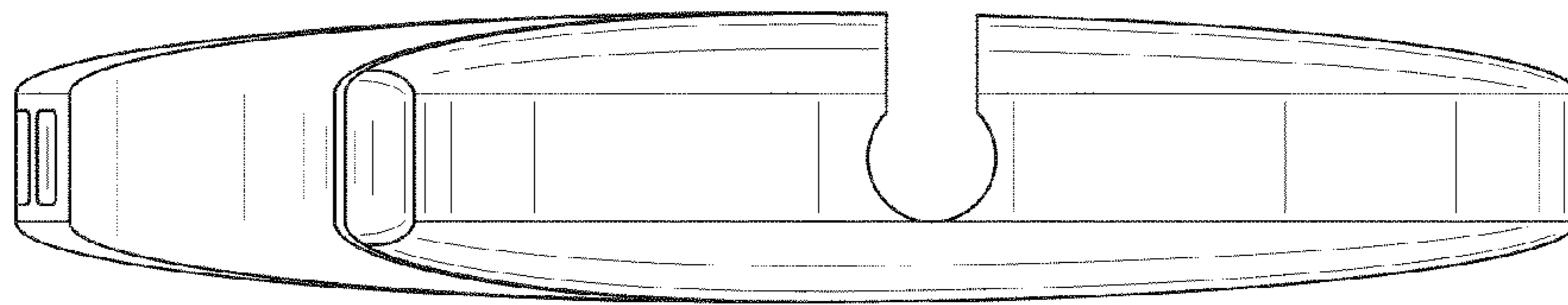

FIG. 6

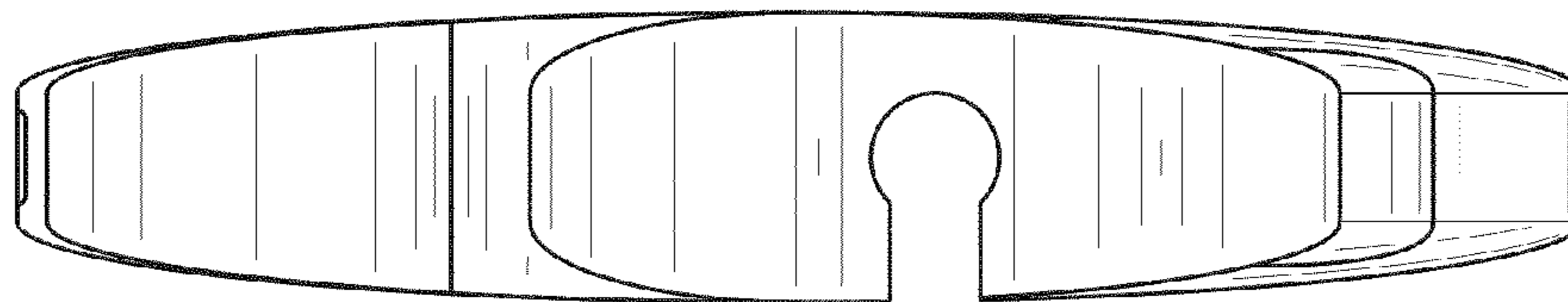

FIG. 7

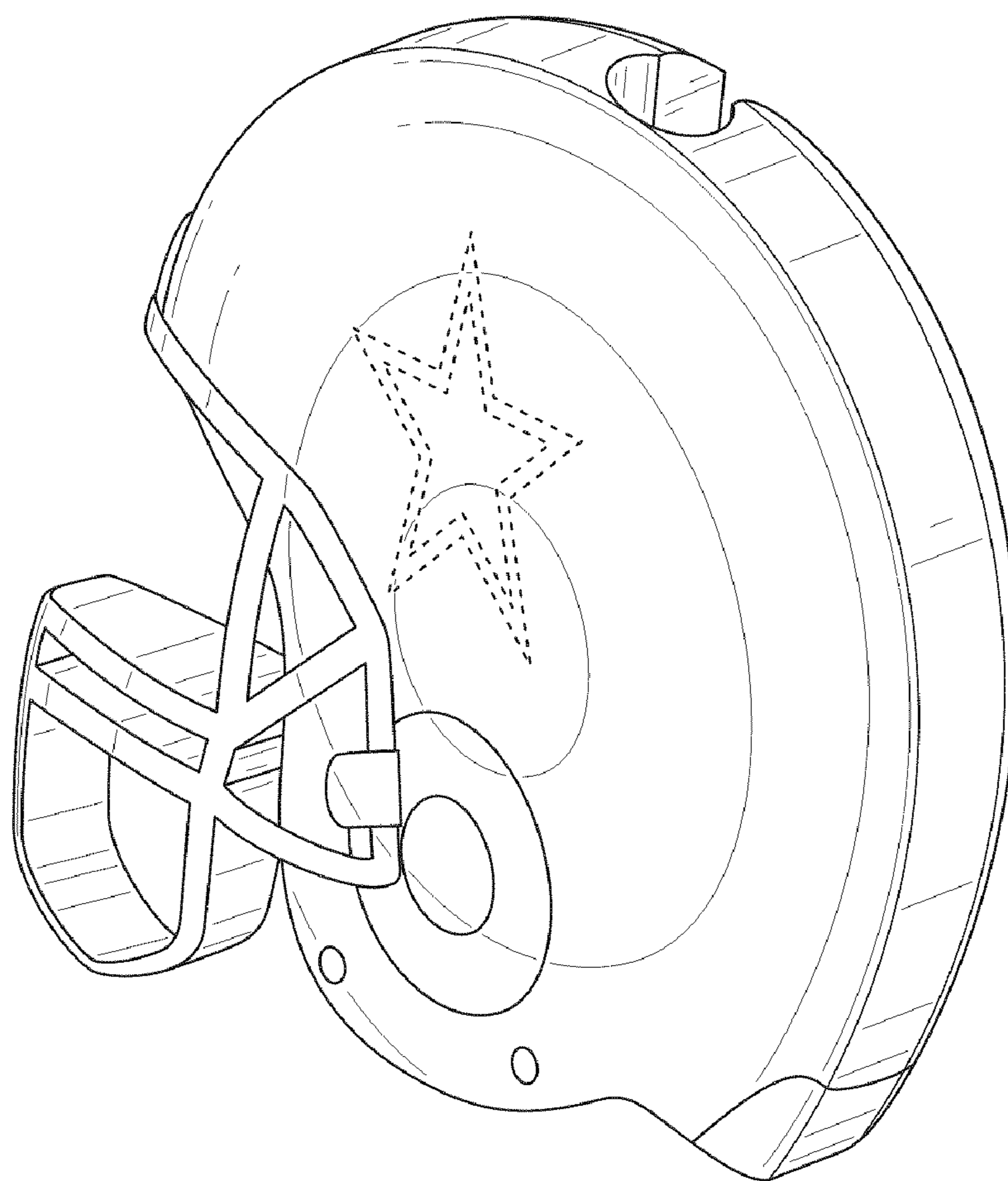

FIG. 8

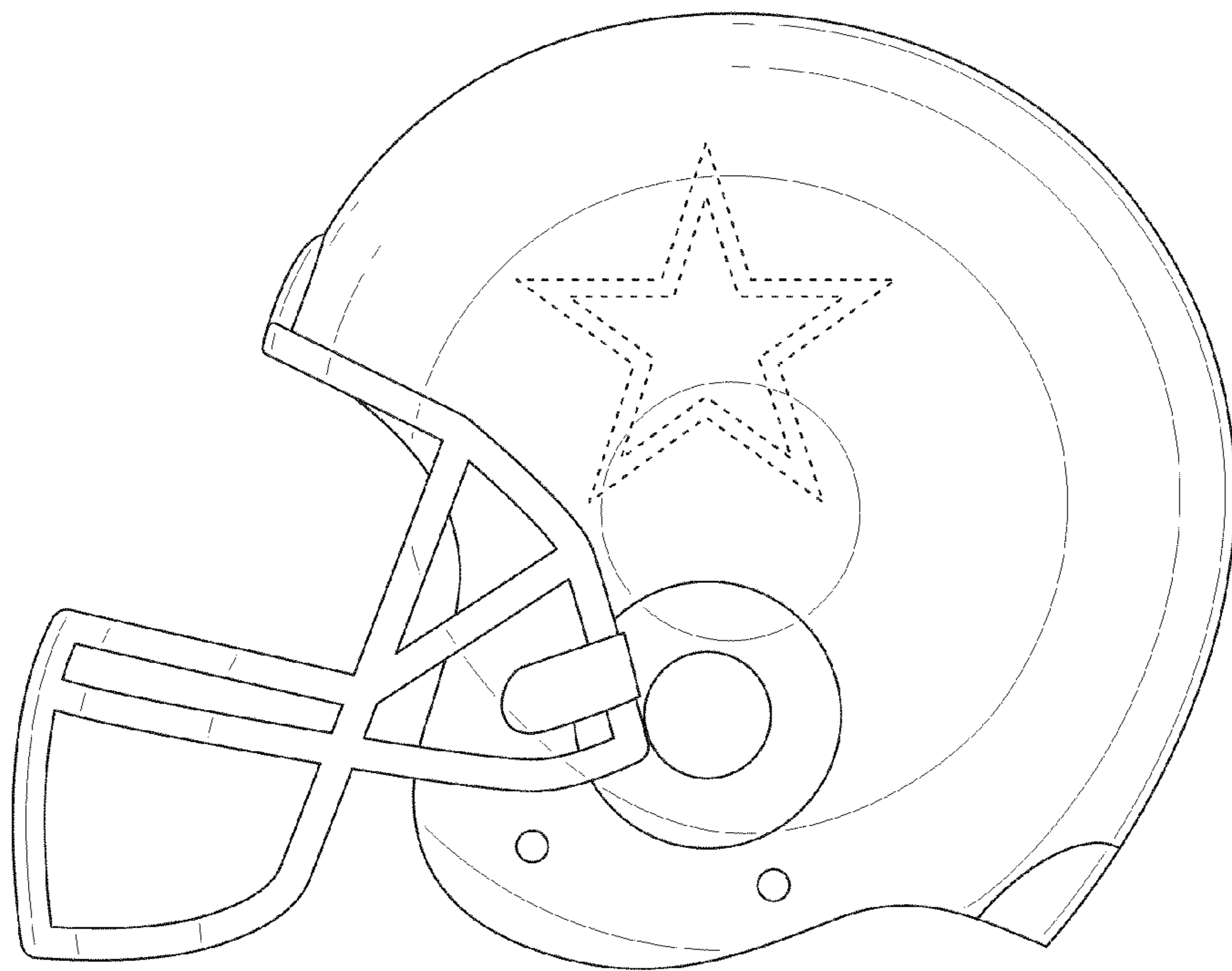

FIG. 9

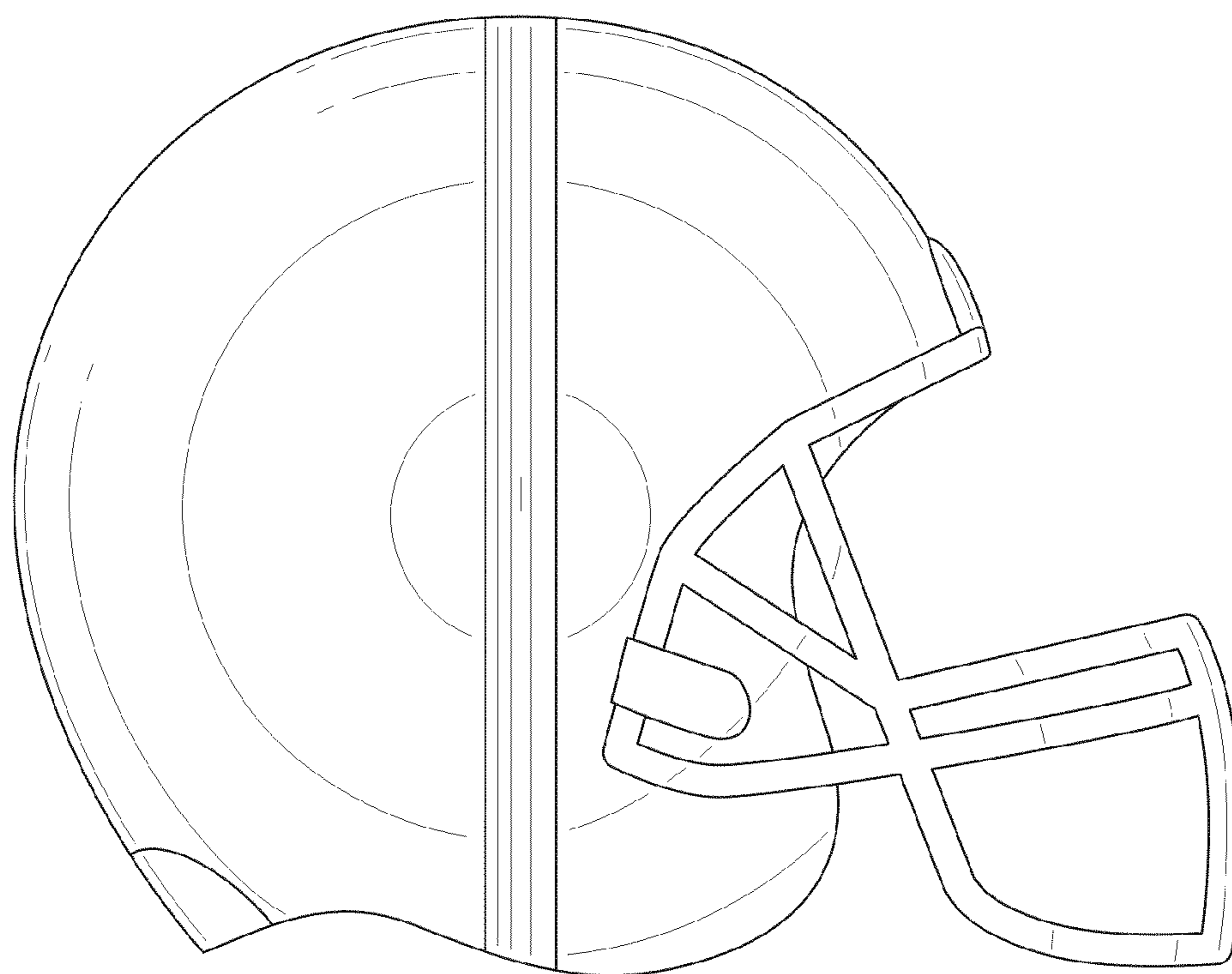

FIG. 10

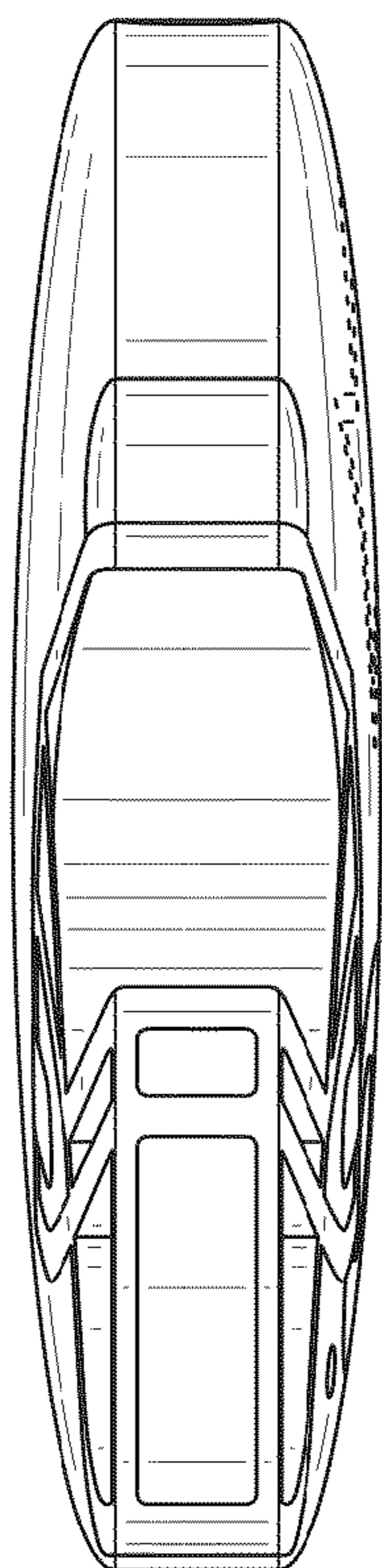

FIG. 11

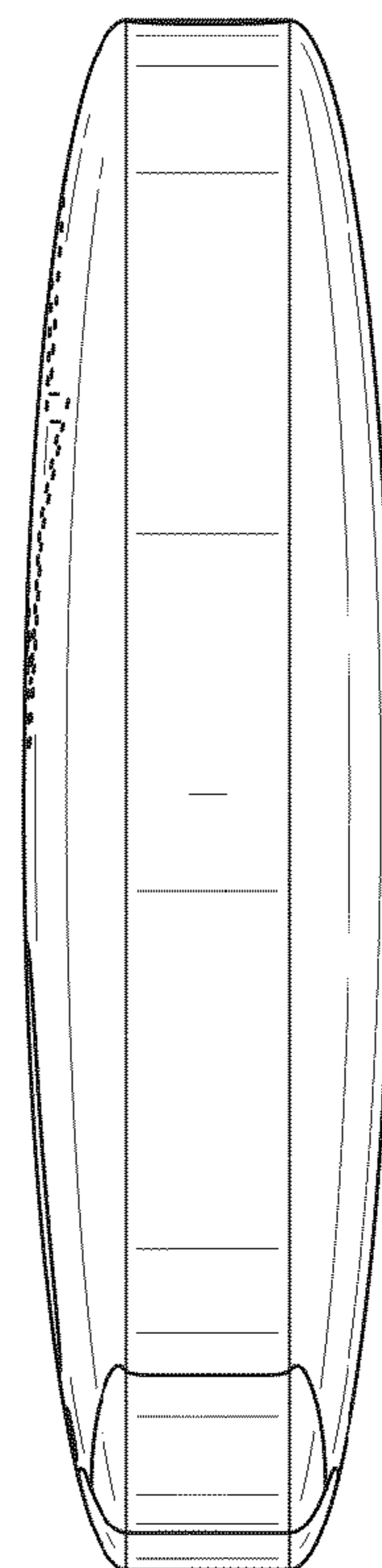

FIG. 12

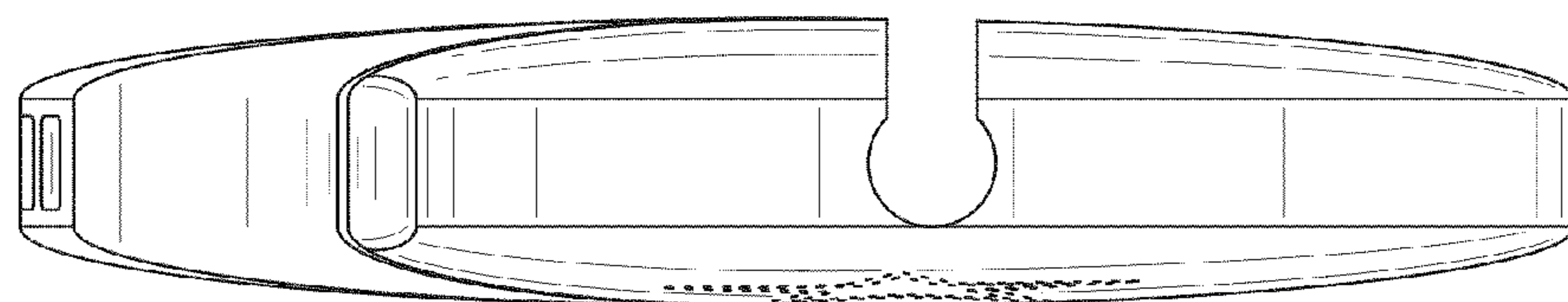

FIG. 13

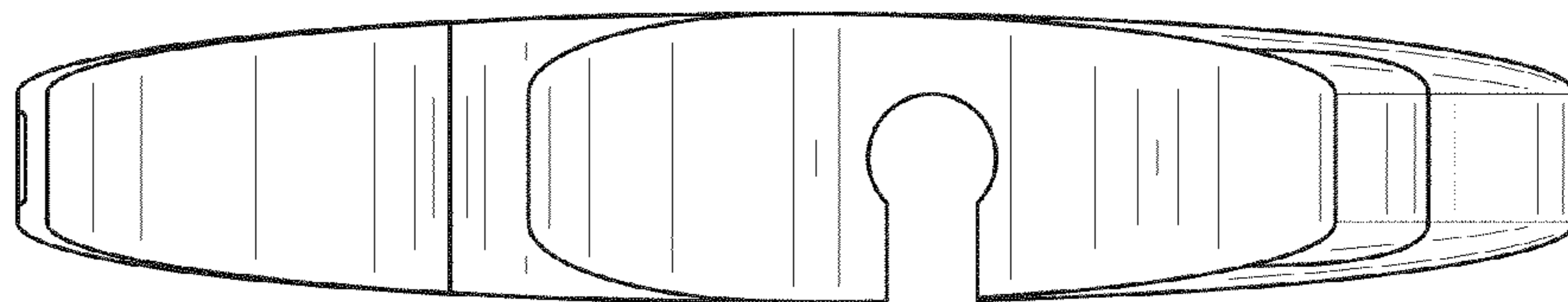

FIG. 14