



US00D653156S

(12) **United States Design Patent**  
**Phelps et al.**

(10) **Patent No.:** **US D653,156 S**  
(45) **Date of Patent:** **\*\* Jan. 31, 2012**

(54) **PLANTER ASSEMBLY**

(76) Inventors: **Robert Phelps**, Warren, OH (US);  
**Belinda Phelps**, Warren, OH (US)

(\*\*) Term: **14 Years**

(21) Appl. No.: **29/390,235**

(22) Filed: **Apr. 21, 2011**

(51) **LOC (9) Cl.** ..... **11-02**

(52) **U.S. Cl.** ..... **D11/143; D11/152**

(58) **Field of Classification Search** ..... D6/403-405,  
D6/556-558; D8/1; D11/143-156, 164;  
D19/77, 80, 81; D25/100; D26/9-11, 16;  
D34/1, 2, 4-6; D99/5, 19; 47/32.4, 32.5,  
47/32.7, 33, 41.01, 41.1, 41.11-41.15, 44-47,  
47/65, 65.5, 65.9, 66.1, 66.2, 66.6, 66.7,  
47/67-71

See application file for complete search history.

(56) **References Cited**

**U.S. PATENT DOCUMENTS**

0,262,335	A	8/1882	Wagner	
2,159,302	A *	5/1939	Rab et al.	D11/154
3,252,252	A *	5/1966	Muelberger, Jr.	D11/143
D262,274	S	12/1981	Lahr	
D281,841	S *	12/1985	Smith	D6/404
4,614,056	A *	9/1986	Farkas	47/67
D295,842	S *	5/1988	Gay	D11/152
4,779,378	A	10/1988	Mason, Jr.	
D306,985	S *	4/1990	Mason, Jr.	D11/143

D309,878	S *	8/1990	Mason, Jr.	D11/143
5,404,672	A	4/1995	Sanderson	
5,440,836	A	8/1995	Lee	
D447,086	S *	8/2001	Weder	D11/164
6,684,565	B2	2/2004	Kemp et al.	
D493,384	S *	7/2004	Jensen	D11/143
7,043,877	B1	5/2006	Jensen	
7,055,282	B2	6/2006	Bryan, III	
D614,081	S *	4/2010	Potts et al.	D11/152
7,690,151	B2	4/2010	Wilkes	
D631,683	S *	2/2011	Ash et al.	D6/558
D635,318	S *	3/2011	Zwade	D34/4

\* cited by examiner

*Primary Examiner* — Garth Rademaker

(57) **CLAIM**

The ornamental design for a planter assembly, as shown and described.

**DESCRIPTION**

FIG. 1 is a front elevated view of a planter assembly showing my new design;

FIG. 2 is a rear elevated view of the planter assembly;

FIG. 3 is a right side elevated view of the planter assembly;

FIG. 4 is a left side elevated view of the planter assembly;

FIG. 5 is a top plan view of the planter assembly;

FIG. 6 is a bottom plan elevated view of the planter assembly;

FIG. 7 is a top isometric view of the planter assembly; and,

FIG. 8 is a bottom isometric view of the planter assembly.

The broken lines shown in FIG. 5 depict environmental subject matter only and form no part of the claimed design.

**1 Claim, 6 Drawing Sheets**

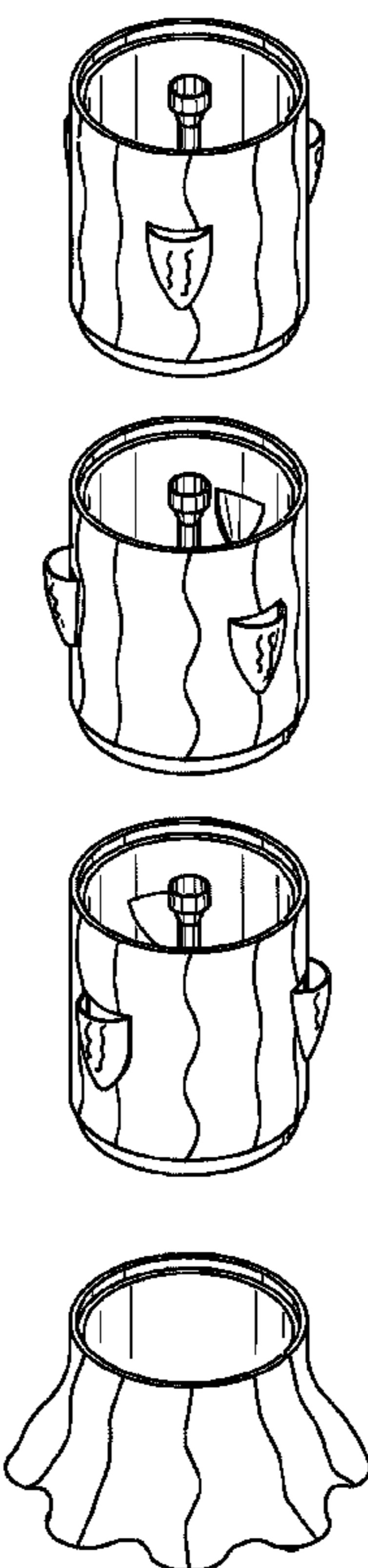

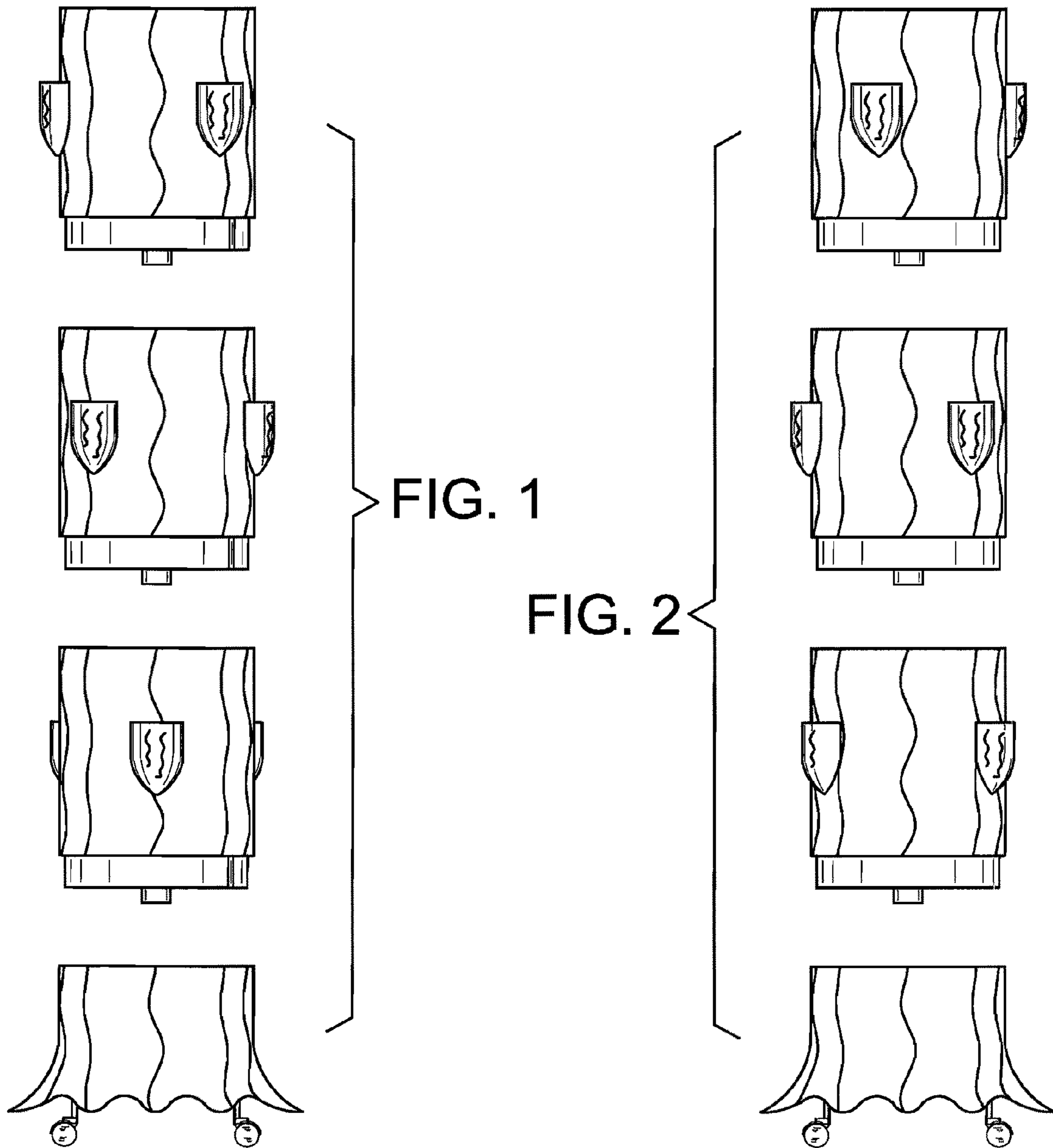

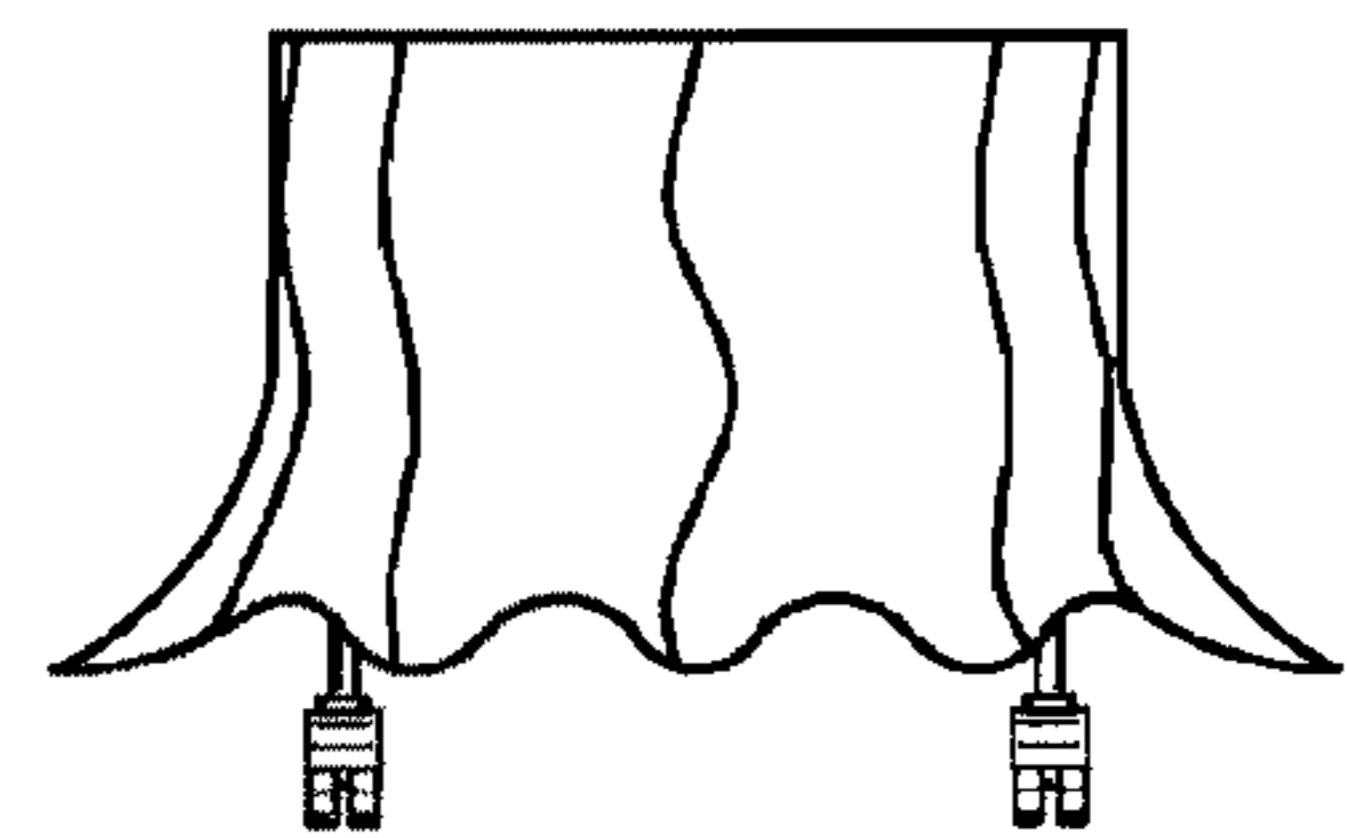
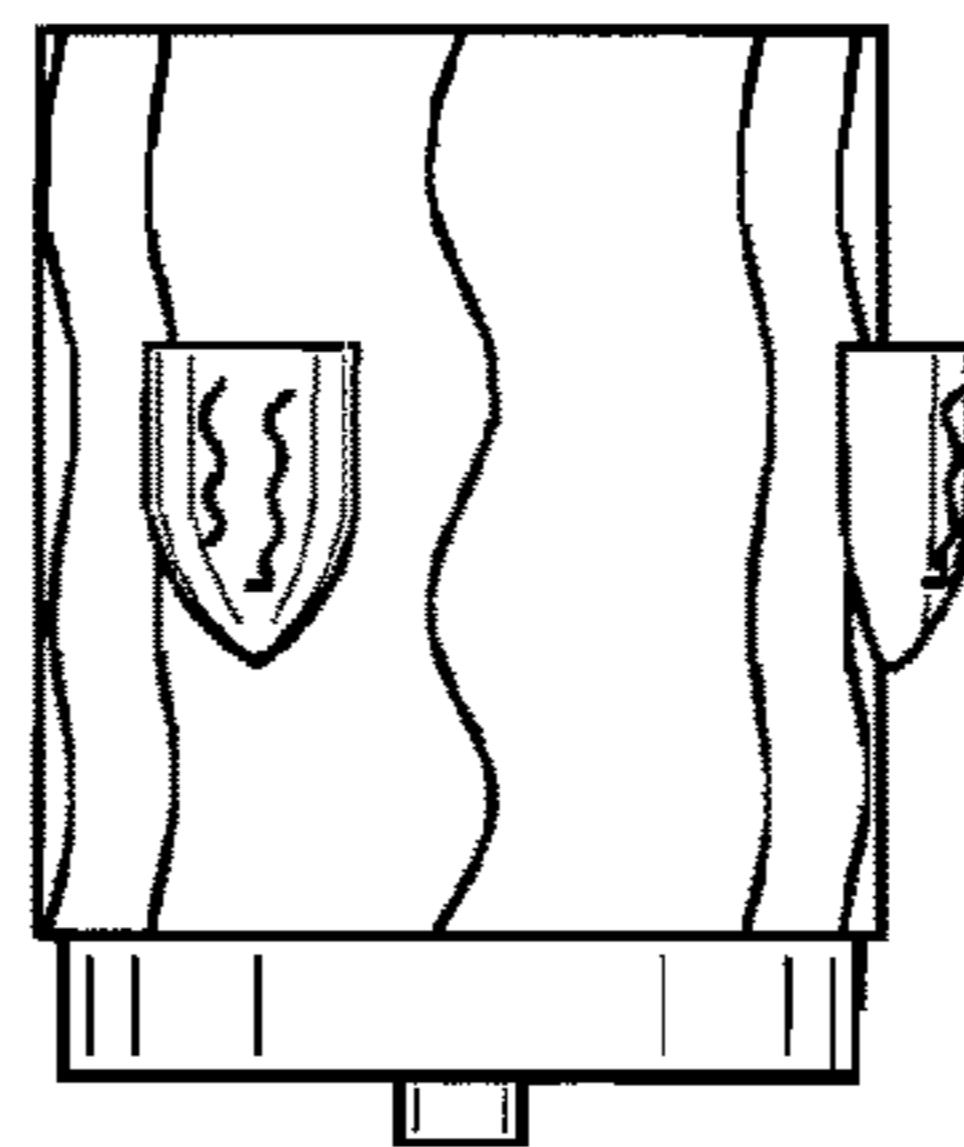
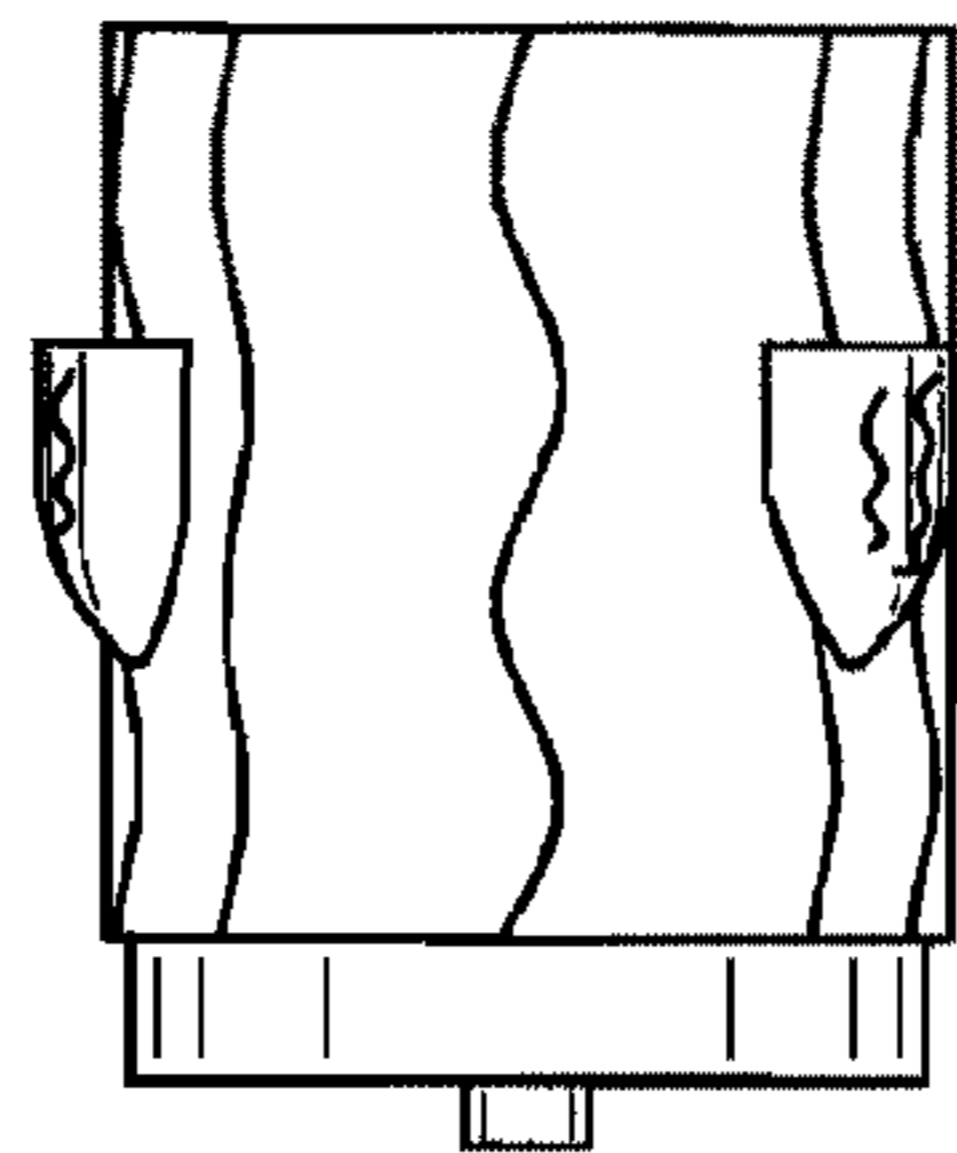
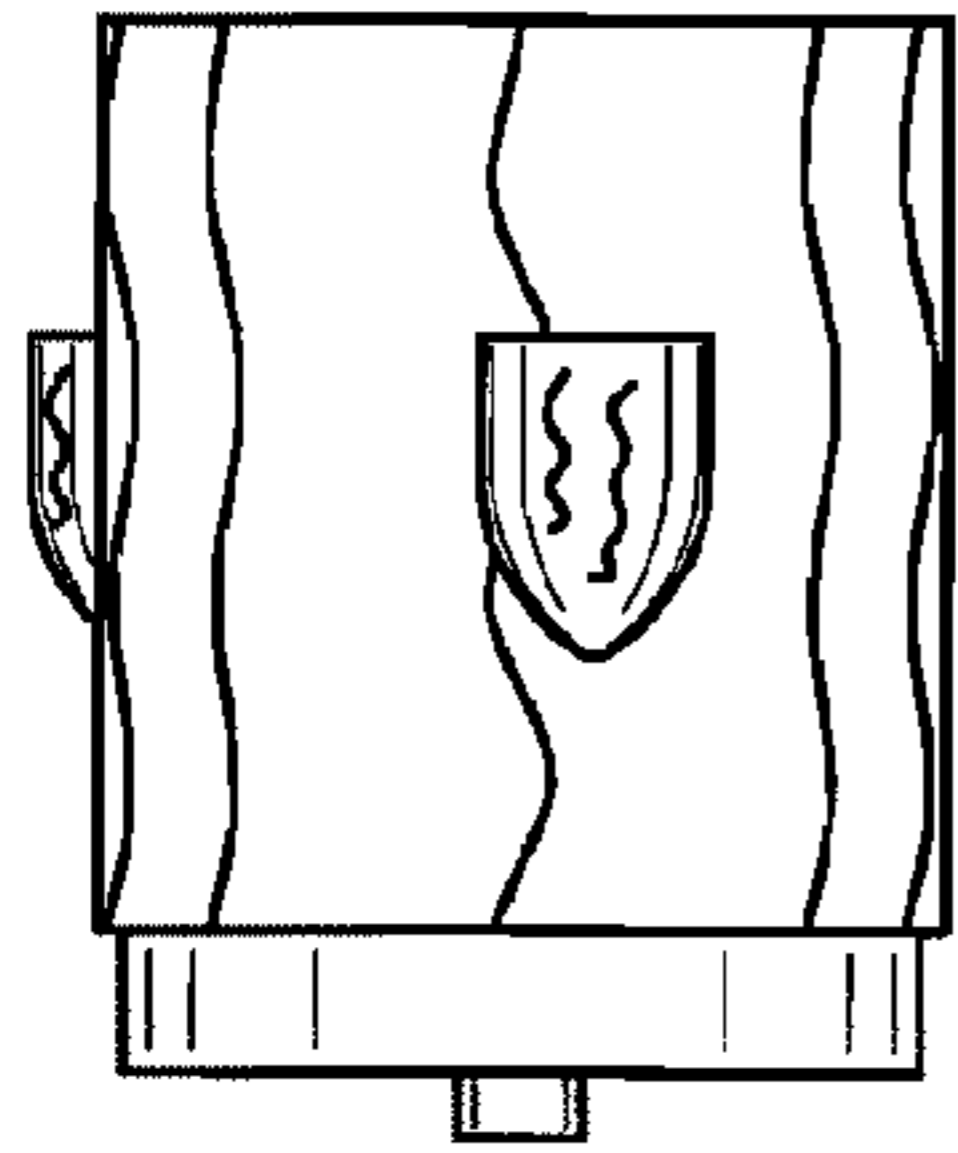
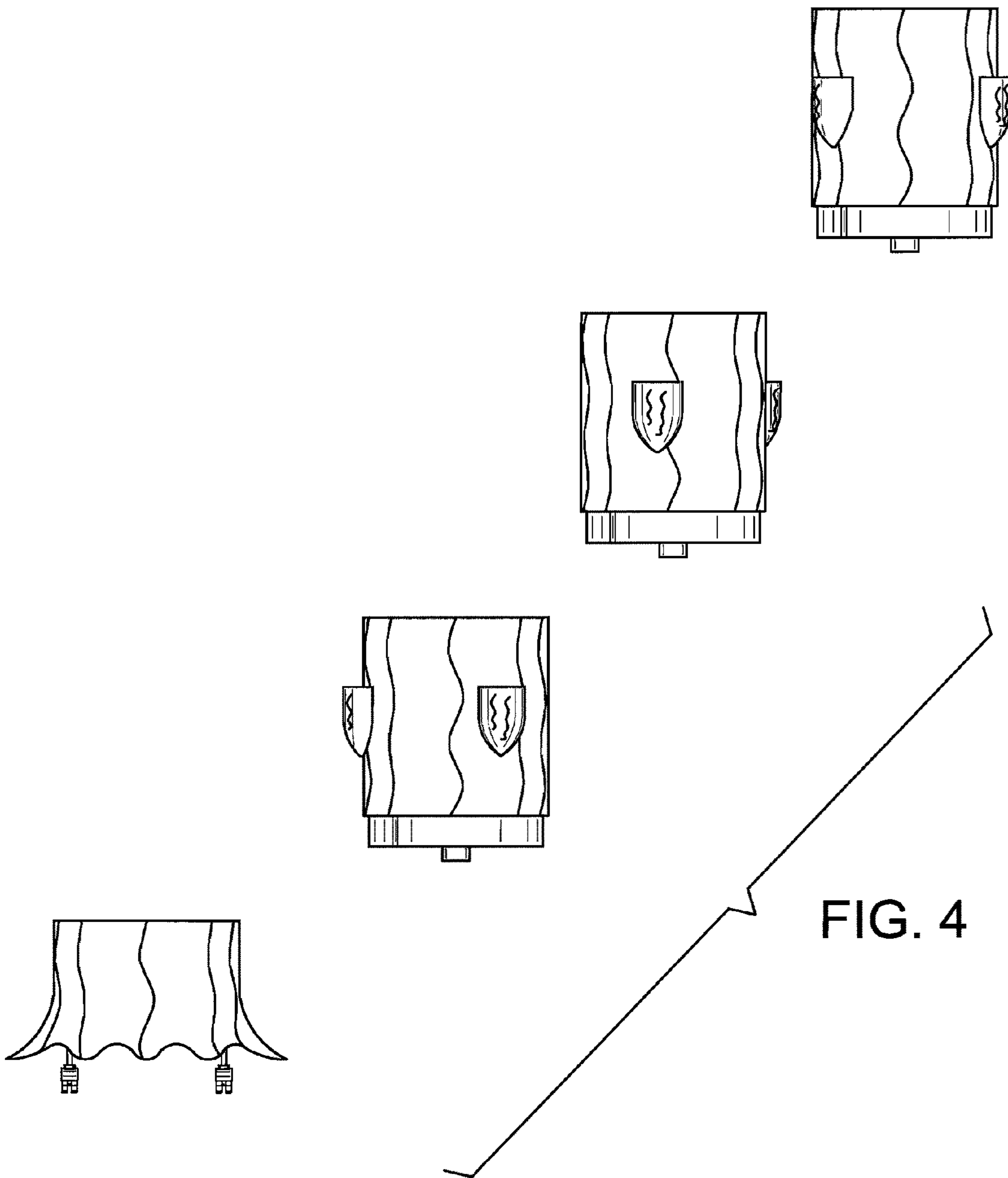

FIG. 3



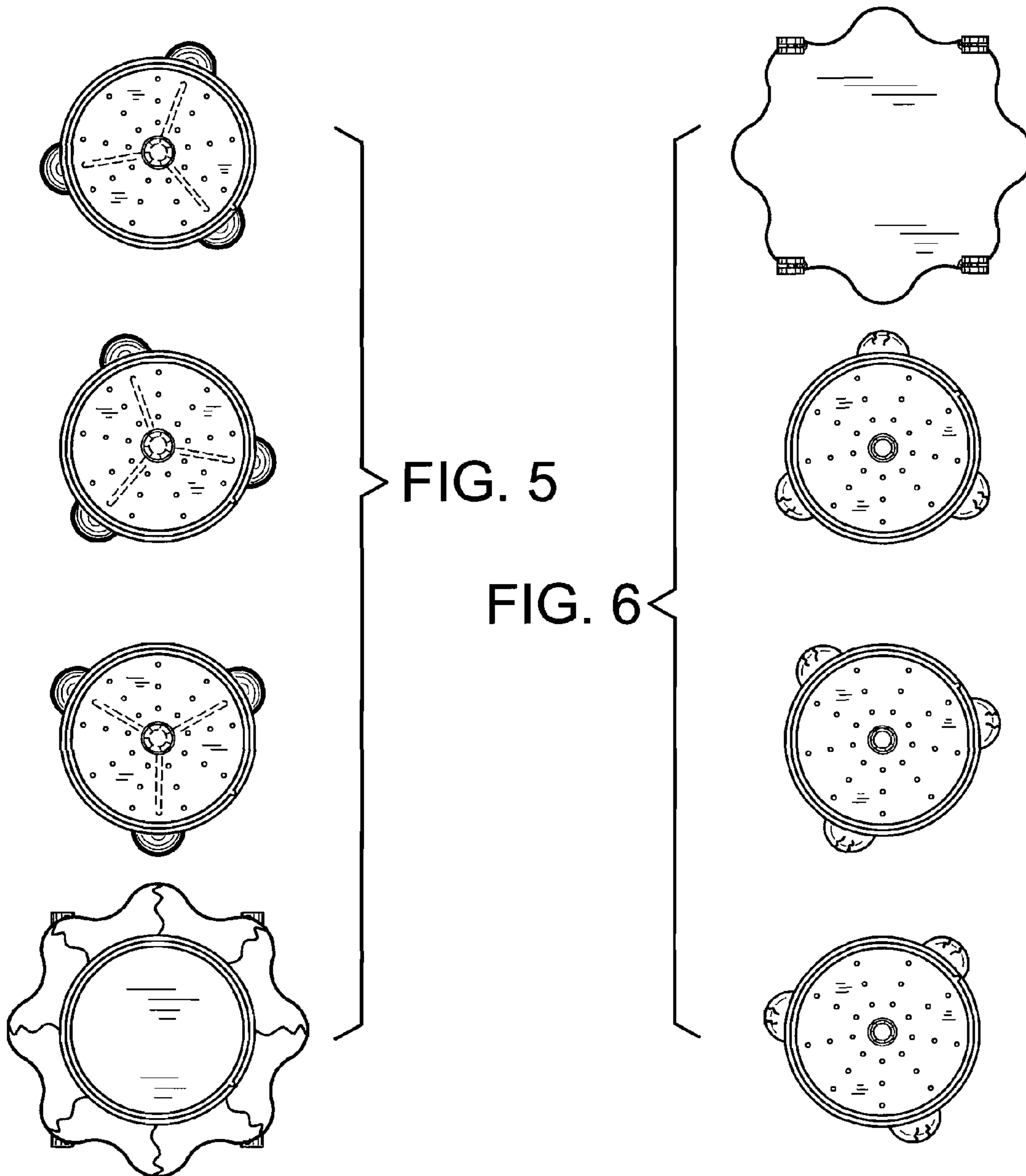



FIG. 7

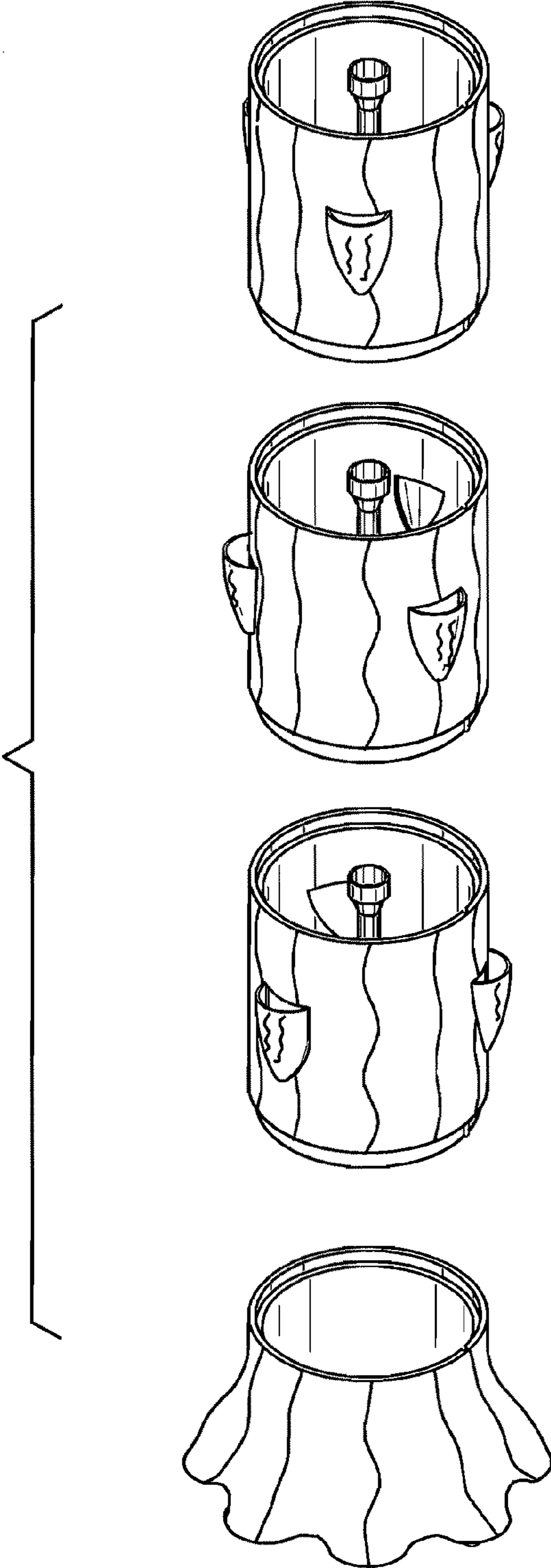

FIG. 8

