



US00D653090S

(12) **United States Design Patent**
Stratford

(10) **Patent No.:** **US D653,090 S**

(45) **Date of Patent:** **** Jan. 31, 2012**

(54) **STRING TRIMMER**

(75) Inventor: **Mark Stratford**, County Durham (GB)

(73) Assignee: **Black & Decker Inc.**, Newark, DE (US)

(**) Term: **14 Years**

(21) Appl. No.: **29/369,097**

(22) Filed: **Sep. 2, 2010**

(30) **Foreign Application Priority Data**

Mar. 4, 2010 (EP) 001199533

(51) **LOC (9) Cl.** **08-01**

(52) **U.S. Cl.** **D8/8**

(58) **Field of Classification Search** D8/7, 8,
D8/9; 30/208, 276, 228, 382, 383, 216; 56/12.7,
56/233-237

See application file for complete search history.

(56) **References Cited**

U.S. PATENT DOCUMENTS

| | | | | |
|--------------|---------|--------------|-------|------|
| D450,226 S * | 11/2001 | Martin | | D8/8 |
| D463,231 S * | 9/2002 | Robson | | D8/8 |
| D463,722 S * | 10/2002 | Robson | | D8/8 |
| D547,143 S * | 7/2007 | Evans et al. | | D8/8 |
| D548,029 S * | 8/2007 | Evans et al. | | D8/8 |
| D552,436 S * | 10/2007 | Stratford | | D8/8 |

| | | | | |
|-------------------|---------|-------------------|-------|--------|
| D566,491 S * | 4/2008 | Martin et al. | | D8/8 |
| D580,719 S * | 11/2008 | Baxter | | D8/8 |
| 2002/0083596 A1 * | 7/2002 | Richardson et al. | | 30/276 |

* cited by examiner

Primary Examiner — Cynthia M Chin

Assistant Examiner — Sheryl Lane

(74) *Attorney, Agent, or Firm* — John Yun

(57) **CLAIM**

The ornamental design for a string trimmer, as shown and described.

DESCRIPTION

FIG. 1 is a perspective view of a string trimmer showing my new design.

FIG. 2 is a left side view of the string trimmer according to FIG. 1.

FIG. 3 is a right side view of the string trimmer according to FIG. 1.

FIG. 4 is a rear view of the string trimmer according to FIG. 1.

FIG. 5 is a front view of the string trimmer according to FIG. 1.

FIG. 6 is a top view of the string trimmer according to FIG. 1; and,

FIG. 7 is a bottom view of the string trimmer according to FIG. 1.

In the drawings the broken lines and the areas within the broken lines form no part of the claimed design.

1 Claim, 6 Drawing Sheets

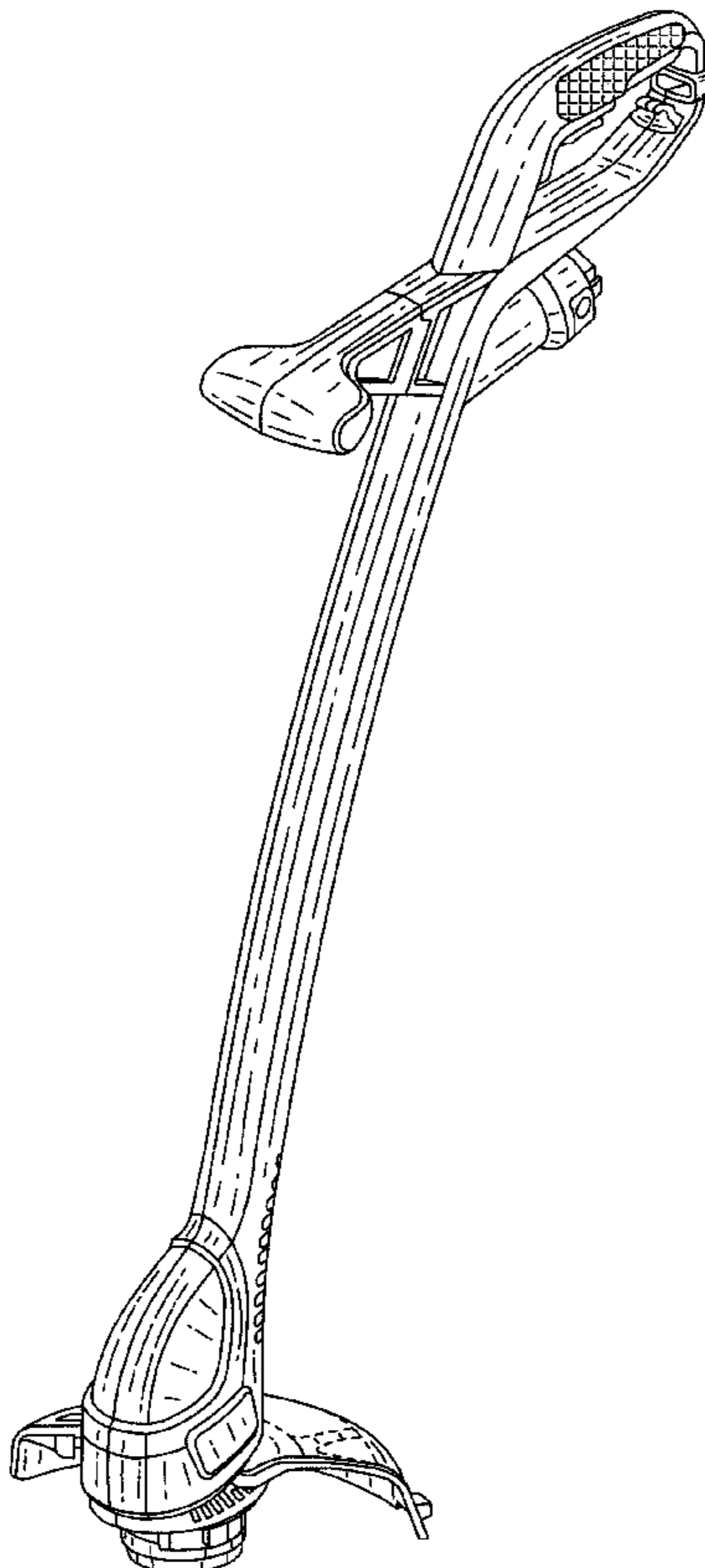

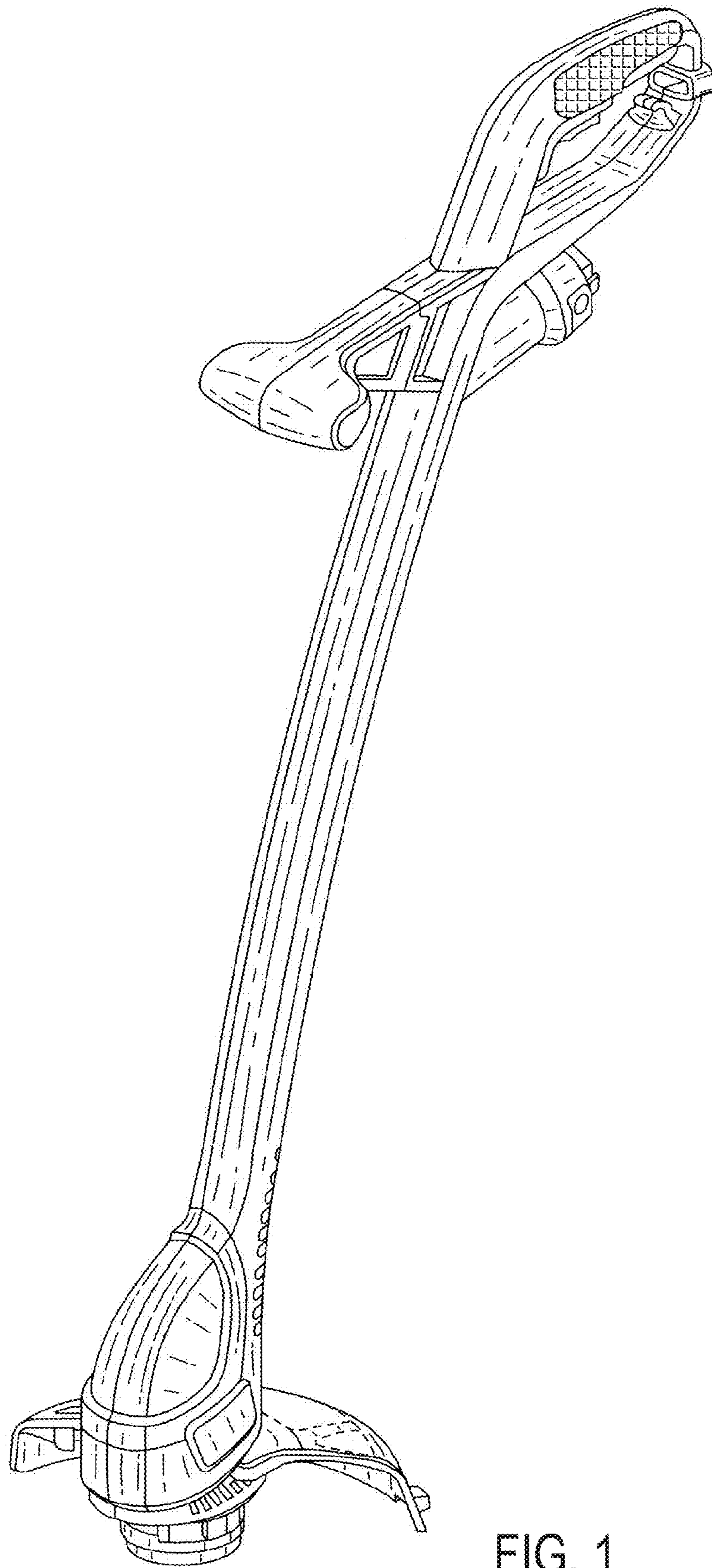

FIG. 1

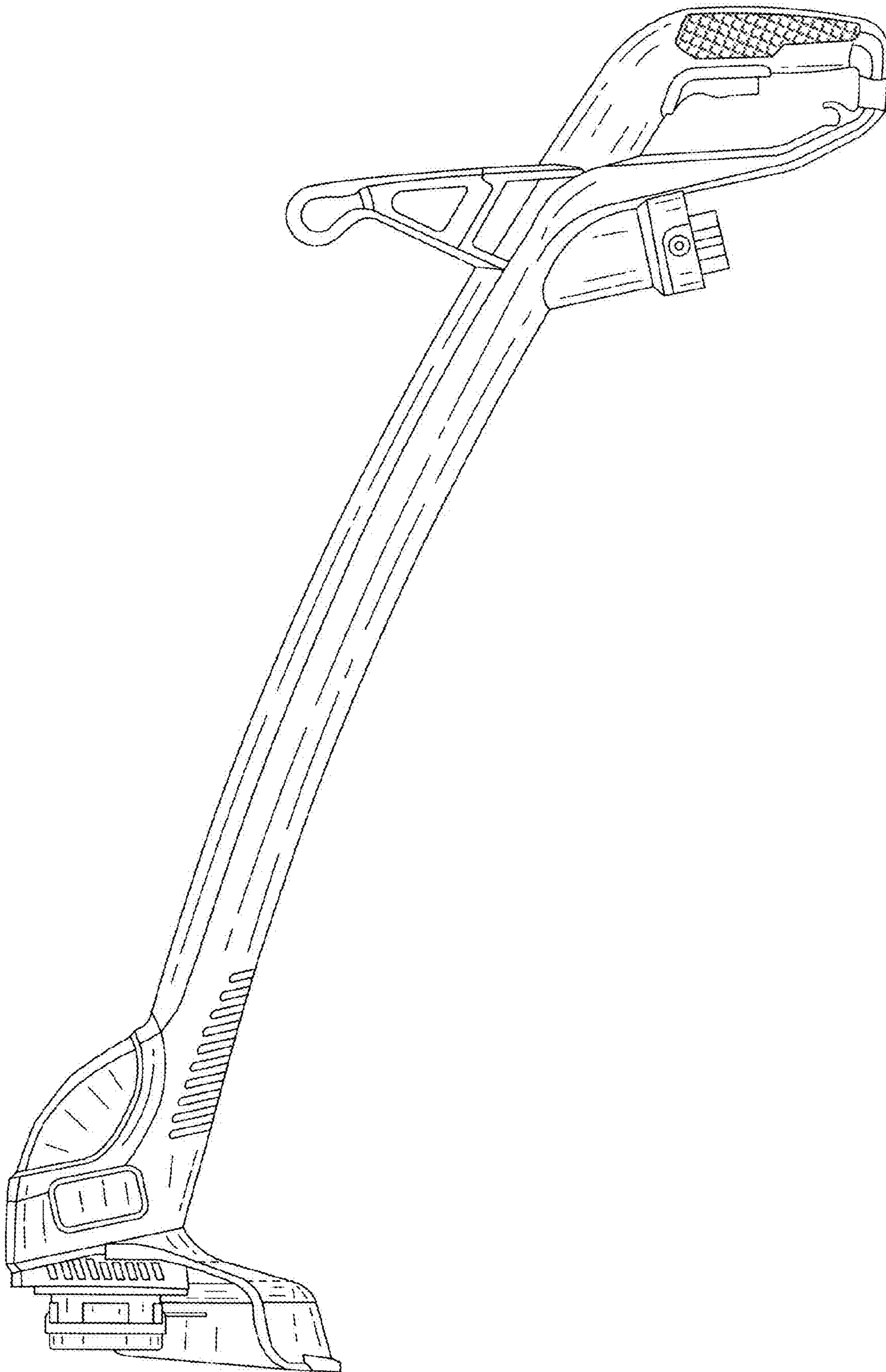

FIG. 2

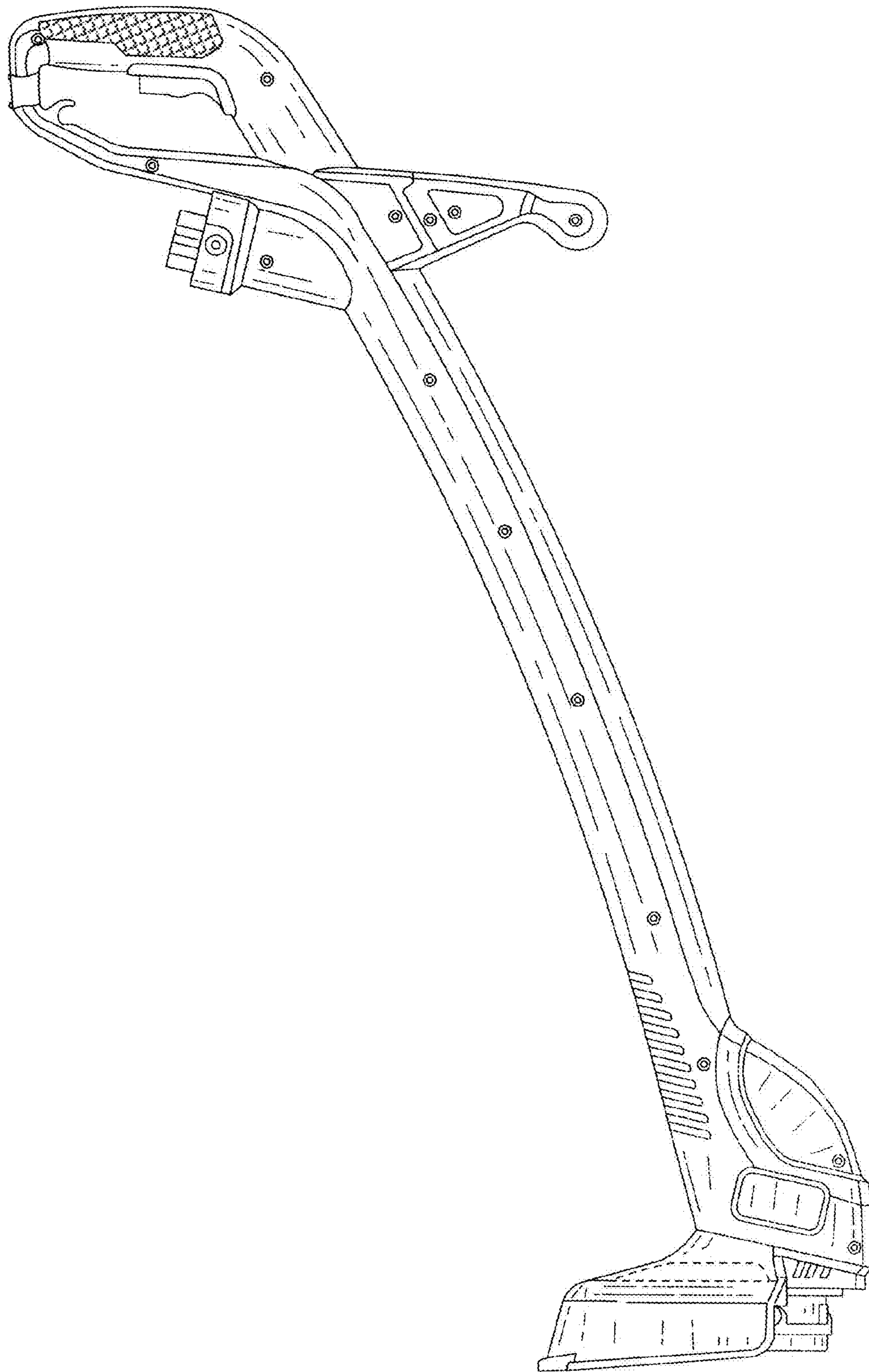

FIG. 3

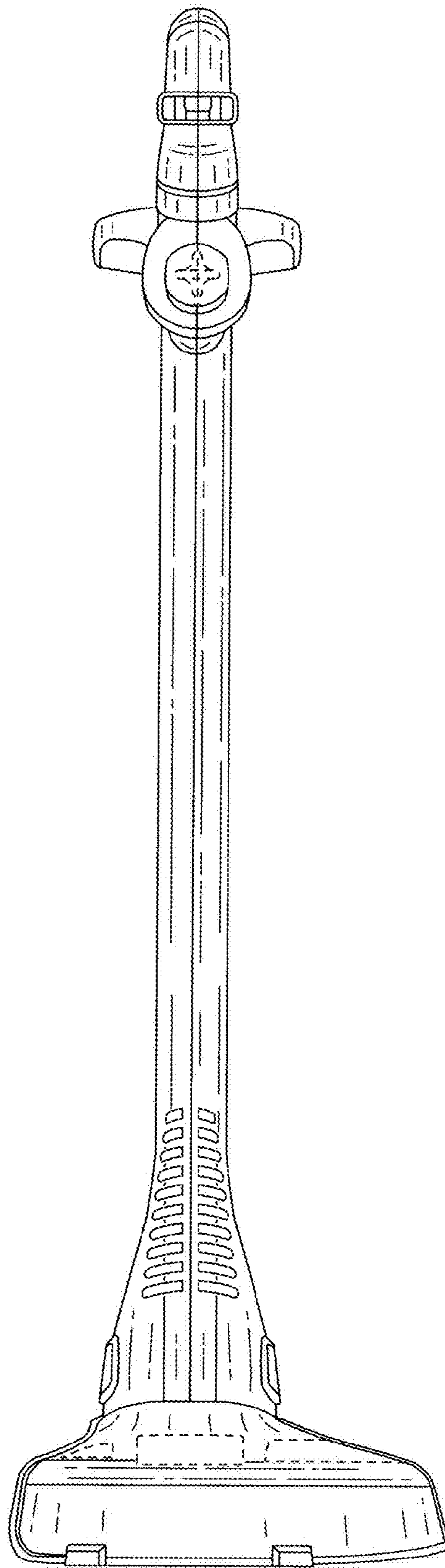

FIG. 4

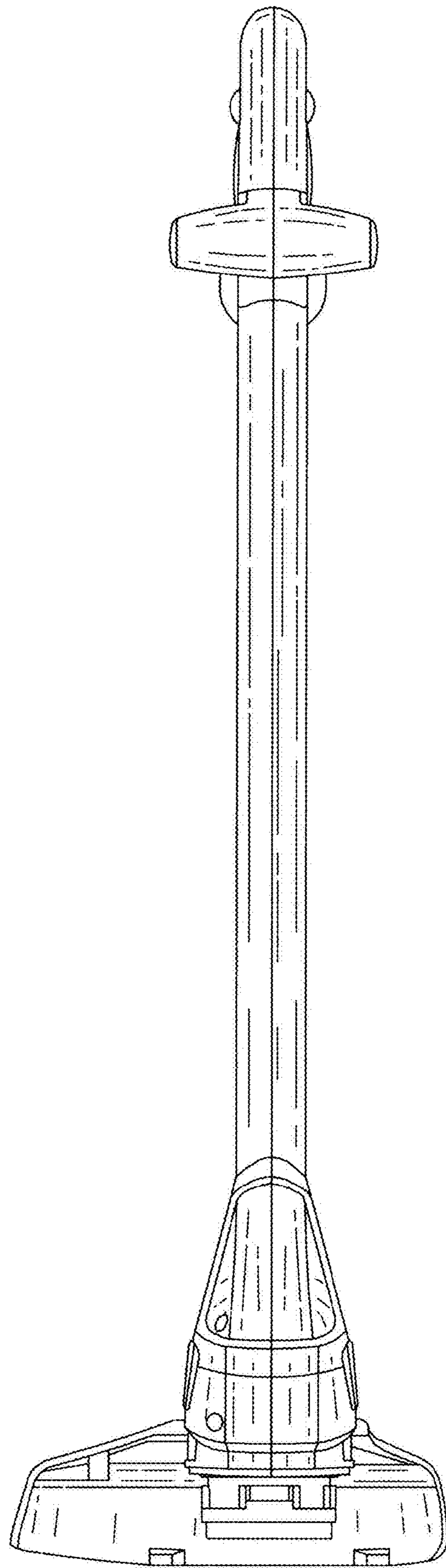

FIG. 5

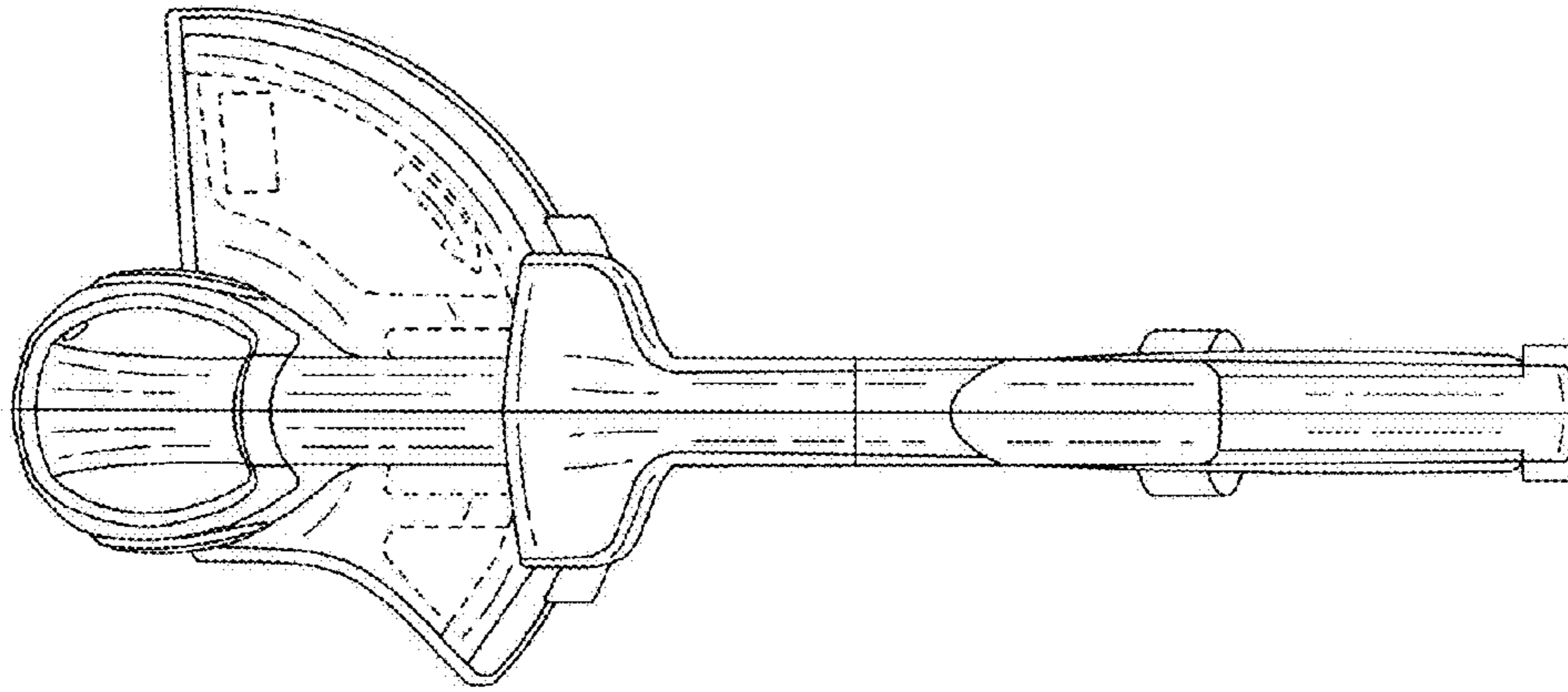

FIG. 6

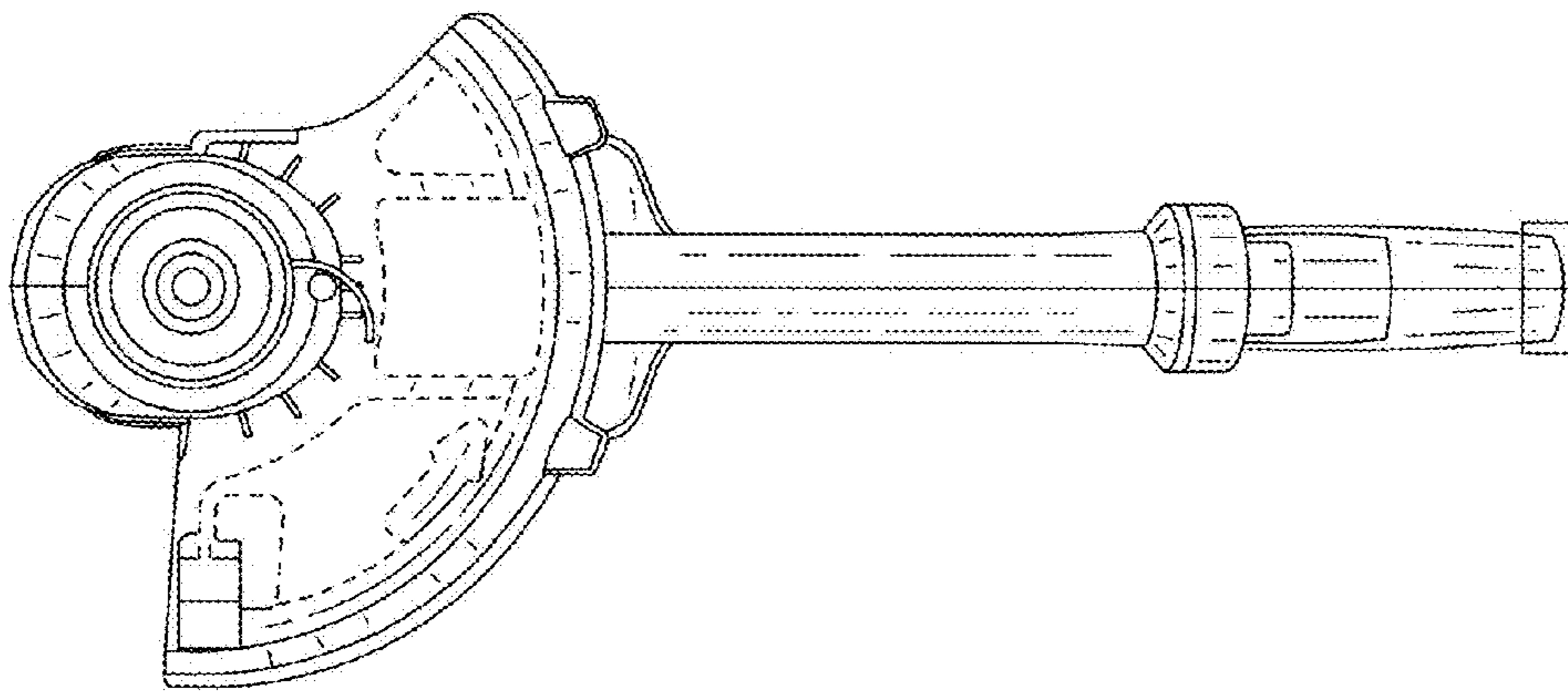

FIG. 7