

US00D653038S

(12) **United States Design Patent**
Park

(10) **Patent No.:** **US D653,038 S**

(45) **Date of Patent:** **** Jan. 31, 2012**

(54) **HAIR BRUSH**

FOREIGN PATENT DOCUMENTS

(76) Inventor: **Ran-Kyu Park**, Seoul (KR)

KR 30-0270006 S * 2/2001
KR 30-0353679 S * 6/2004
KR 30-0454081 S * 6/2007

(**) Term: **14 Years**

* cited by examiner

(21) Appl. No.: **29/397,902**

Primary Examiner — Melanie H Tung

Assistant Examiner — Lavone D Tabor

(22) Filed: **Jul. 22, 2011**

(74) *Attorney, Agent, or Firm* — Cantor Colburn LLP

(51) **LOC (9) Cl.** **04-02**

(57) **CLAIM**

(52) **U.S. Cl.** **D4/128**

The ornamental design for a hair brush, as shown and described.

(58) **Field of Classification Search** D4/127,
D4/128, 136; D28/10, 35, 37; 15/27, 159.1,
15/160, 186–188; 132/120, 262, 271, 313
See application file for complete search history.

DESCRIPTION

(56) **References Cited**

U.S. PATENT DOCUMENTS

D238,631 S * 2/1976 Leighton D4/128
D301,404 S * 6/1989 Fischer D4/128
D479,916 S 9/2003 Park
D518,644 S 4/2006 Park

FIG. 1 is a perspective view of a hair brush showing my new design;
FIG. 2 is a front view thereof;
FIG. 3 is a rear view thereof;
FIG. 4 is a left side view thereof;
FIG. 5 is a right side view thereof;
FIG. 6 is a top plan view thereof;
FIG. 7 is a bottom plan view thereof; and,
FIG. 8 is a sectional view taken along the line 8-8 in FIG. 2.

1 Claim, 7 Drawing Sheets

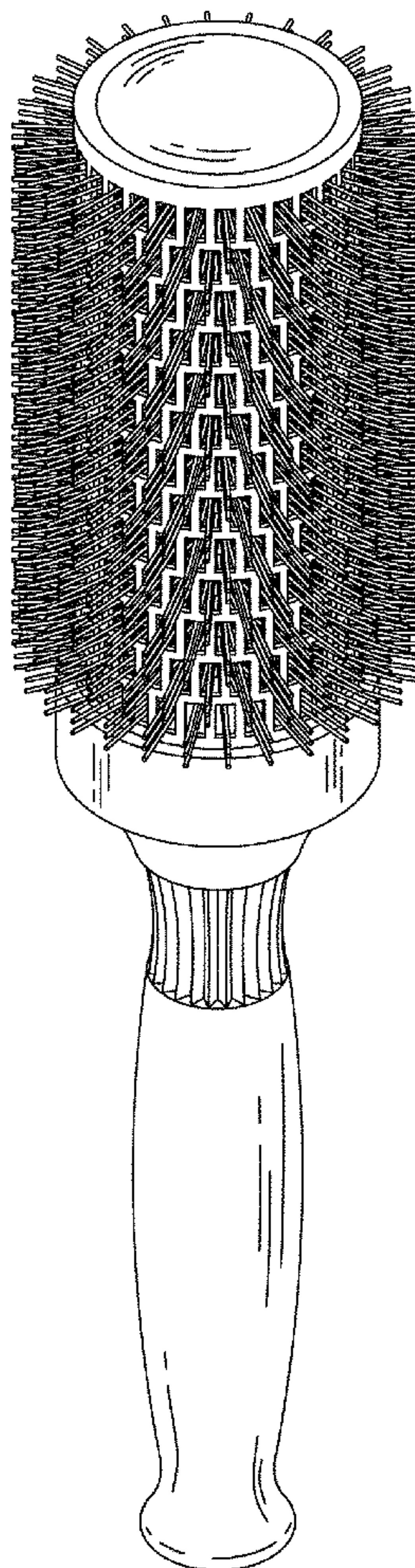

FIG. 1

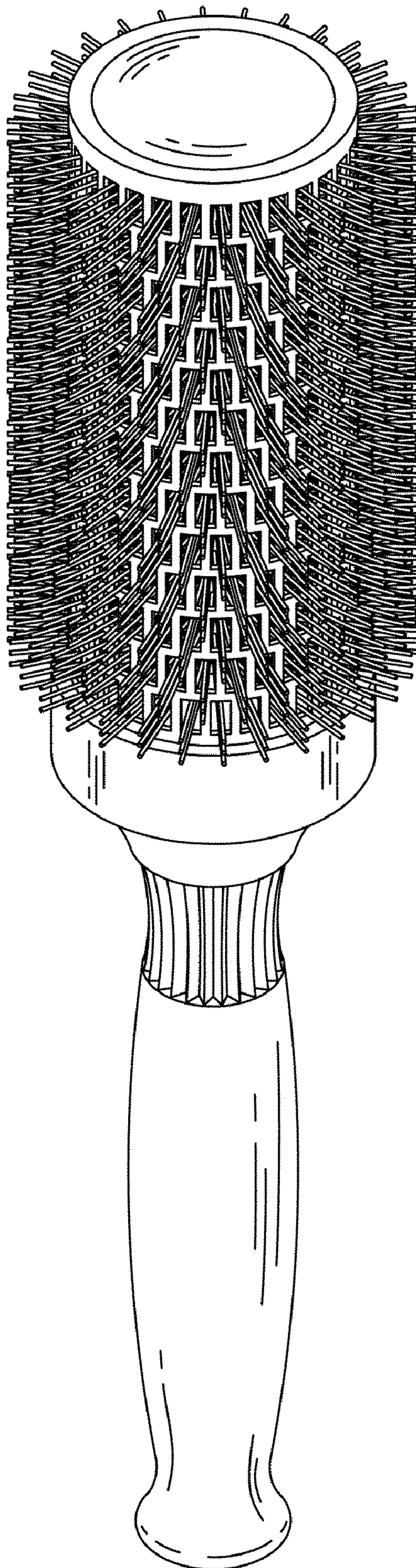

FIG. 2

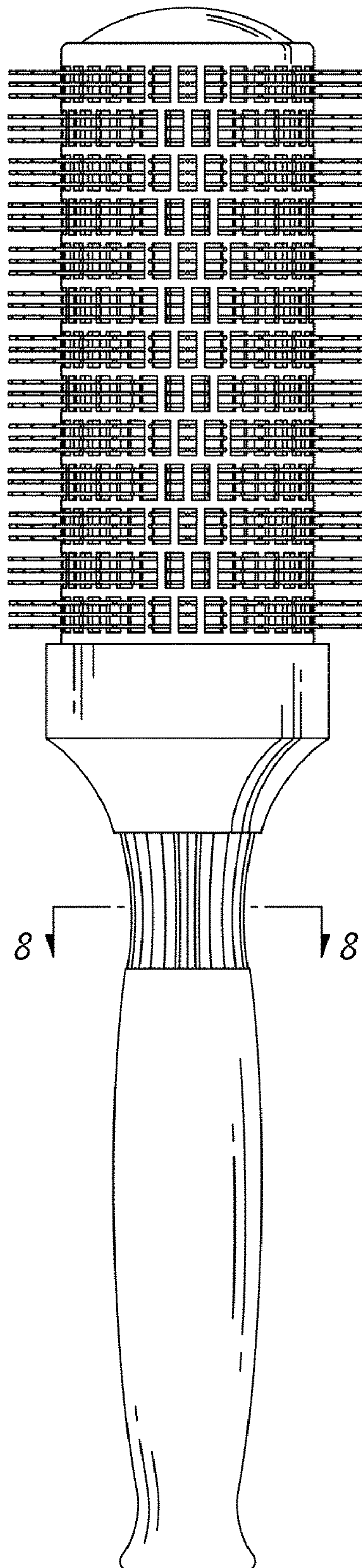

FIG. 3

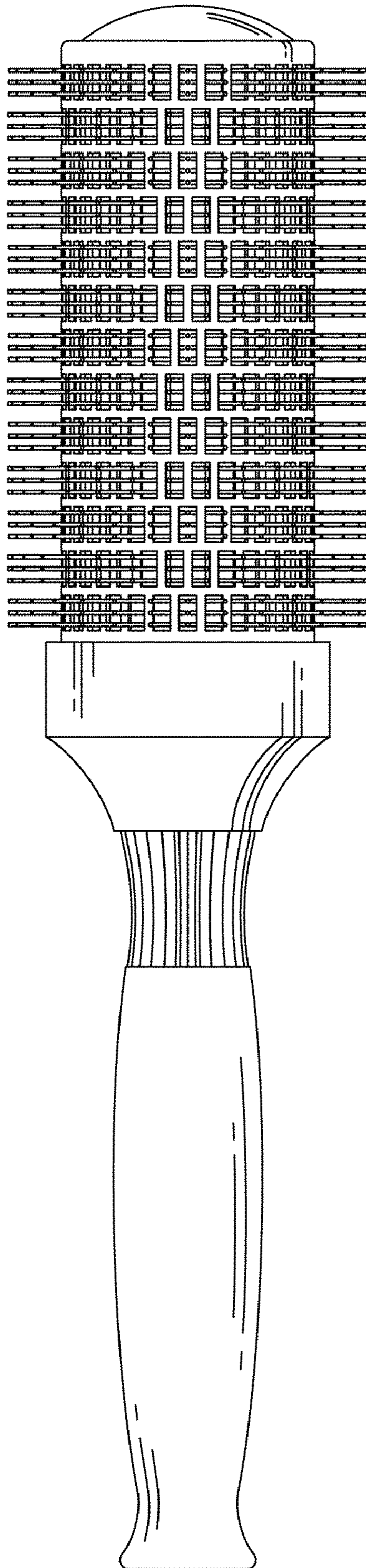

FIG. 4

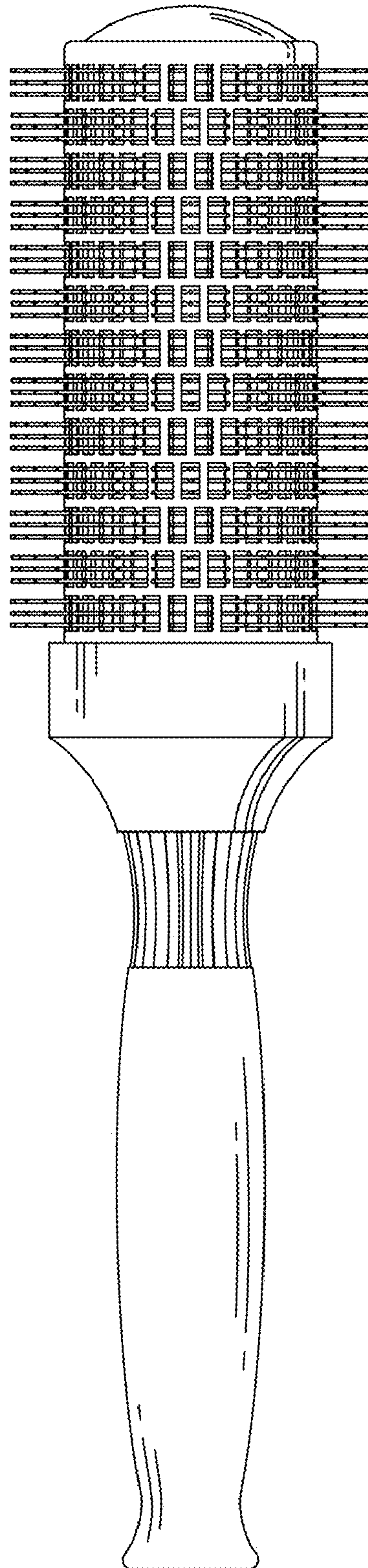

FIG. 5

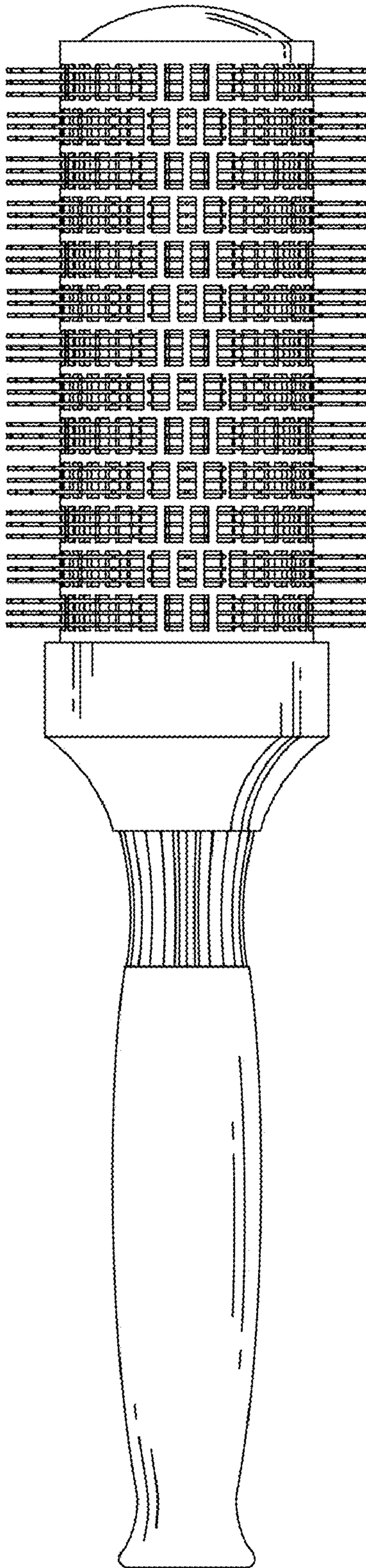

FIG. 6

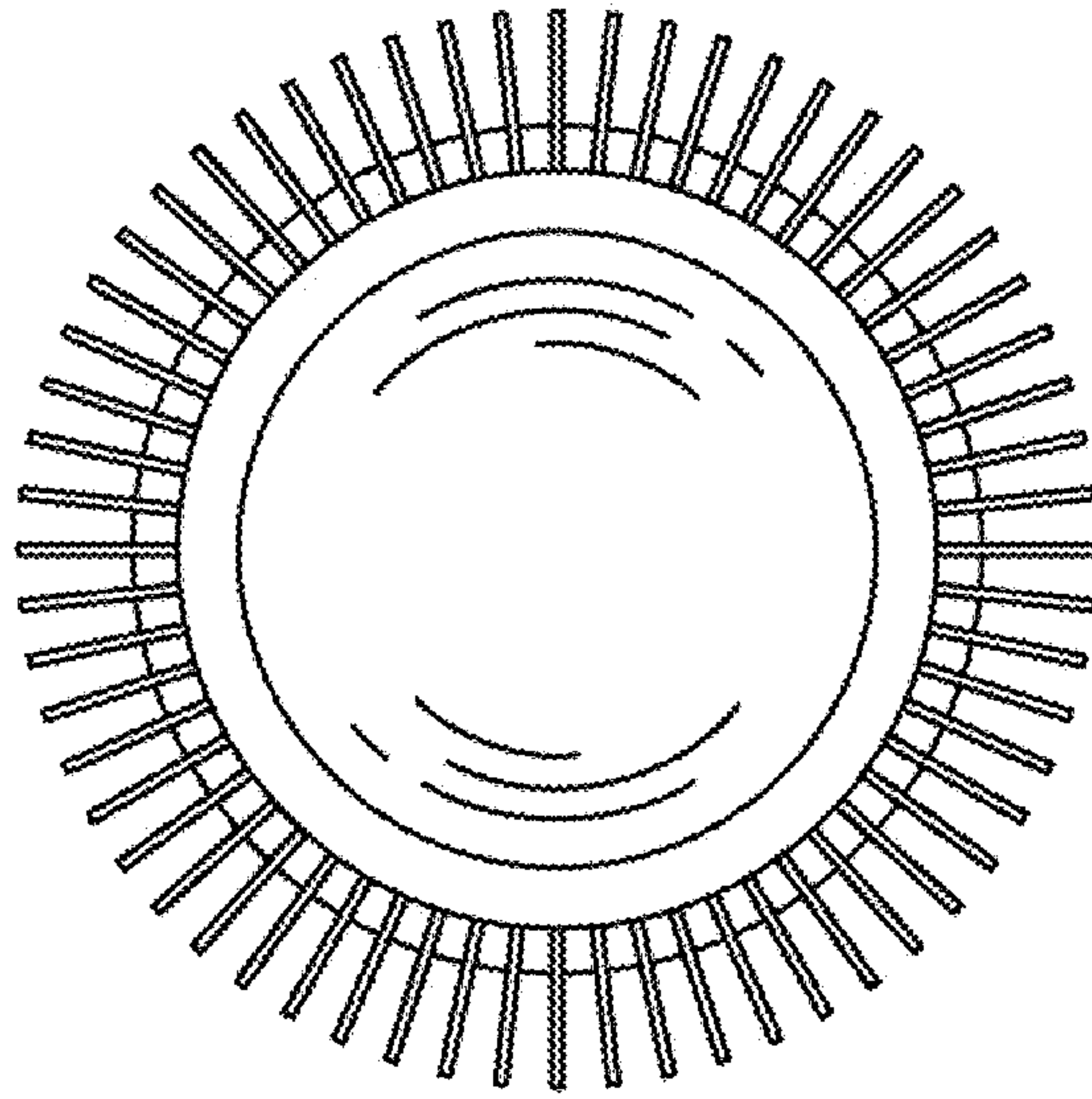

FIG. 7

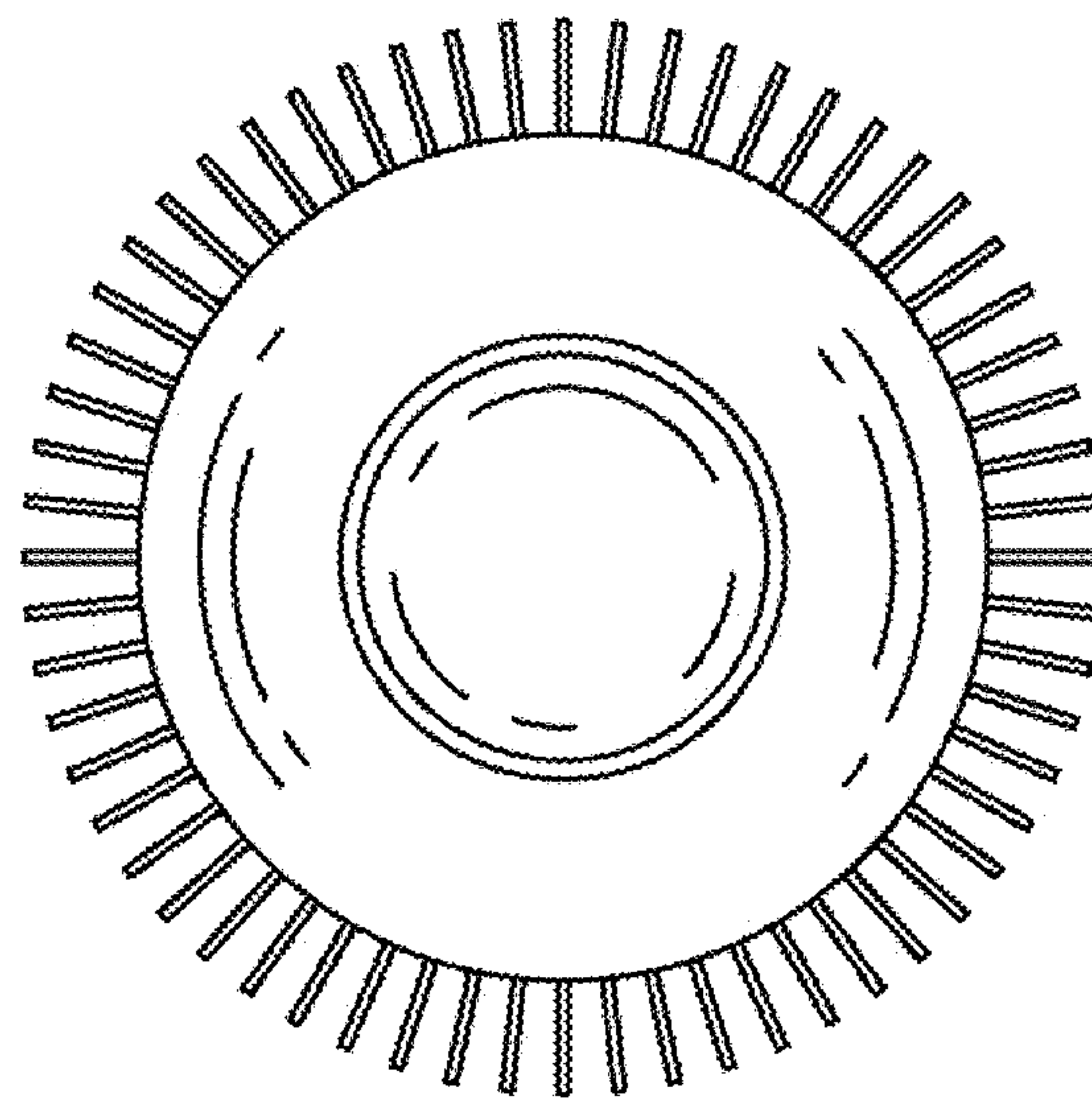

FIG. 8

