

US00D653025S

(12) **United States Design Patent**
Brown

(10) **Patent No.:** **US D653,025 S**
(45) **Date of Patent:** **** Jan. 31, 2012**

(54) **BLANKET COVER FOR BABY CARRYING HARNESS**

D517,807 S 3/2006 Rothwell
7,287,676 B2 * 10/2007 Chua 224/160
2005/0045674 A1 * 3/2005 Rehbein 224/160
2006/0130220 A1 6/2006 Morgan et al.

(76) Inventor: **Michelle A. Brown**, Rancho Cucamonga, CA (US)

* cited by examiner

(**) Term: **14 Years**

Primary Examiner — T. Chase Nelson
Assistant Examiner — Michael Pratt

(21) Appl. No.: **29/344,641**

(74) *Attorney, Agent, or Firm* — Montgomery Patent & Design, LLC; Robert C. Montgomery; Joseph T. Yaksich

(22) Filed: **Oct. 1, 2009**

(51) **LOC (9) Cl.** **03-99**

(52) **U.S. Cl.** **D3/213**

(58) **Field of Classification Search** D3/213–215;
D6/354; 224/155, 157, 158, 159, 160, 161,
224/264, 270, 907; 446/28; 2/84–85, 94–95,
2/102, 108; 5/94; D2/719, 828–831
See application file for complete search history.

(57) **CLAIM**

The ornamental design for a blanket cover for baby carrying harness, as shown and described.

DESCRIPTION

FIG. 1 is an environmental view of a blanket cover for baby carrying harness showing my new design;
FIG. 2 is a front view of the blanket cover for baby carrying harness of FIG. 1;
FIG. 3 is a rear view thereof;
FIG. 4 is a right side view thereof;
FIG. 5 is a left side view thereof;
FIG. 6 is a top view thereof; and,
FIG. 7 is a bottom view thereof.
The broken lines are for illustrative purposes only and forms no part of the claimed design.

(56) **References Cited**

U.S. PATENT DOCUMENTS

D260,695 S	9/1981	Brookfield	
5,243,724 A	9/1993	Barnes	
5,611,095 A	3/1997	Schneider	
D395,188 S *	6/1998	Rush	D6/603
5,897,164 A	4/1999	Kagan et al.	
6,434,750 B1	8/2002	Hunter	
6,547,325 B2	4/2003	Drost et al.	
D485,676 S *	1/2004	Simpson	D3/213

1 Claim, 6 Drawing Sheets

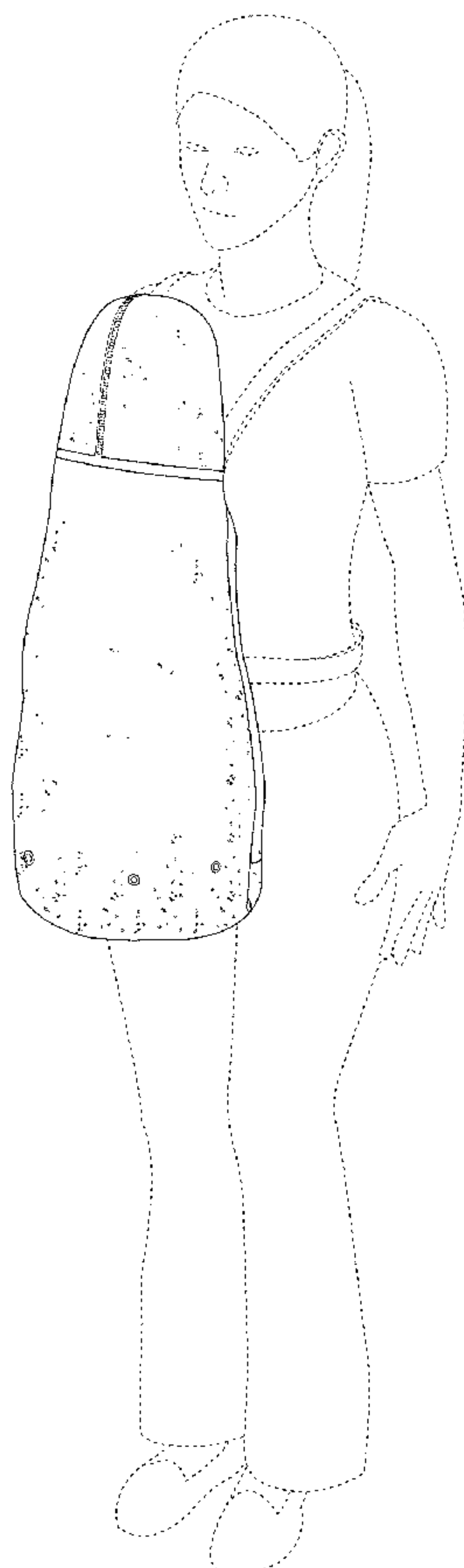

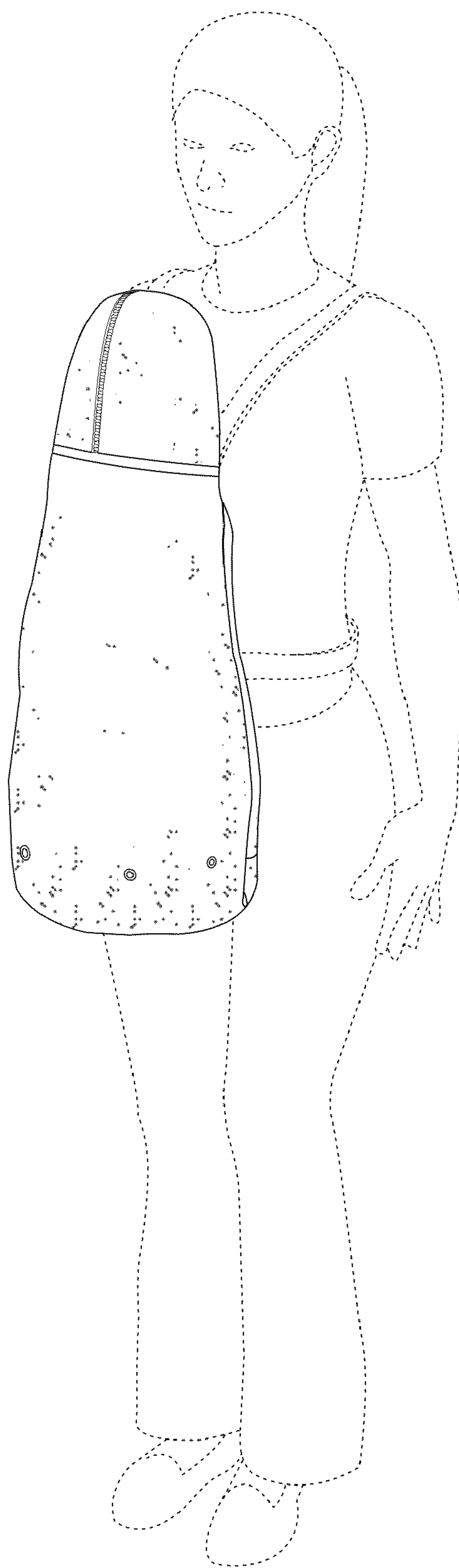

Fig. 1

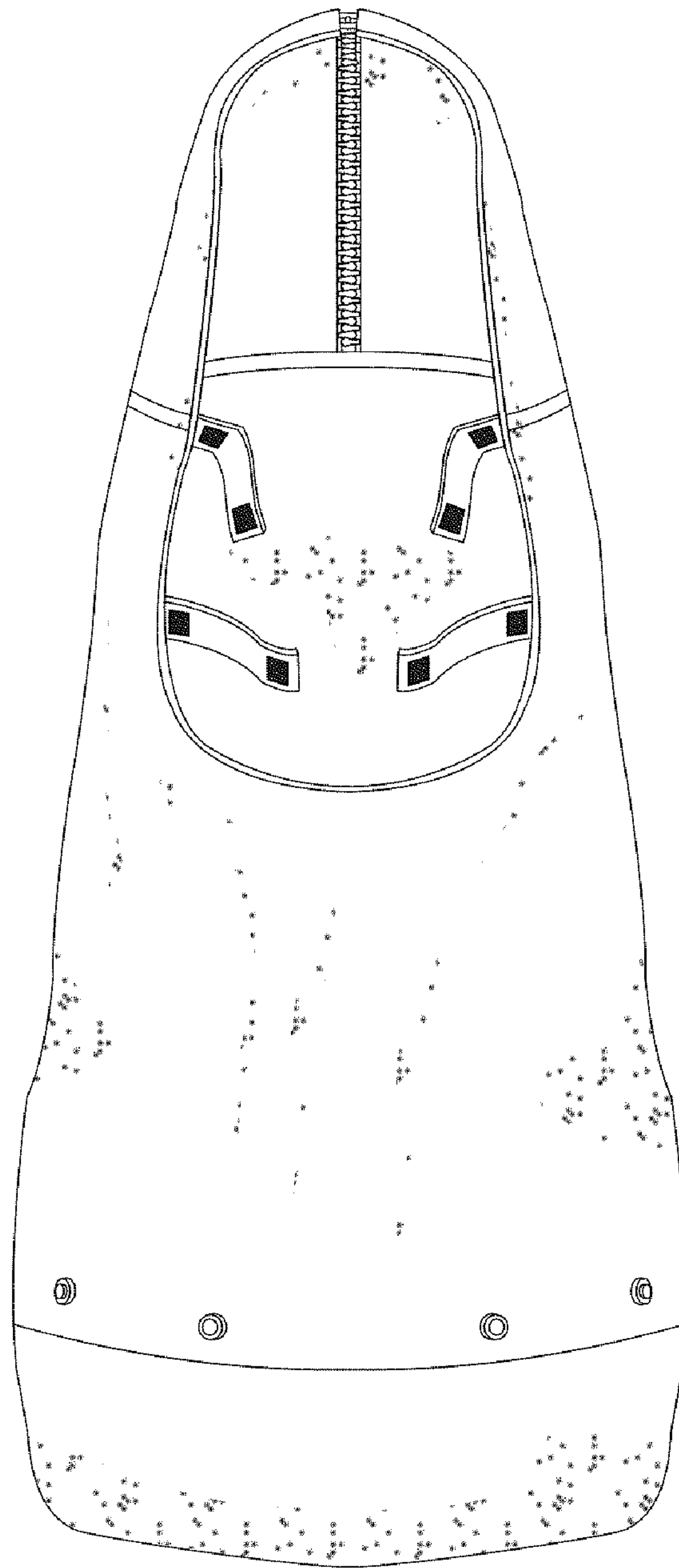

Fig. 2

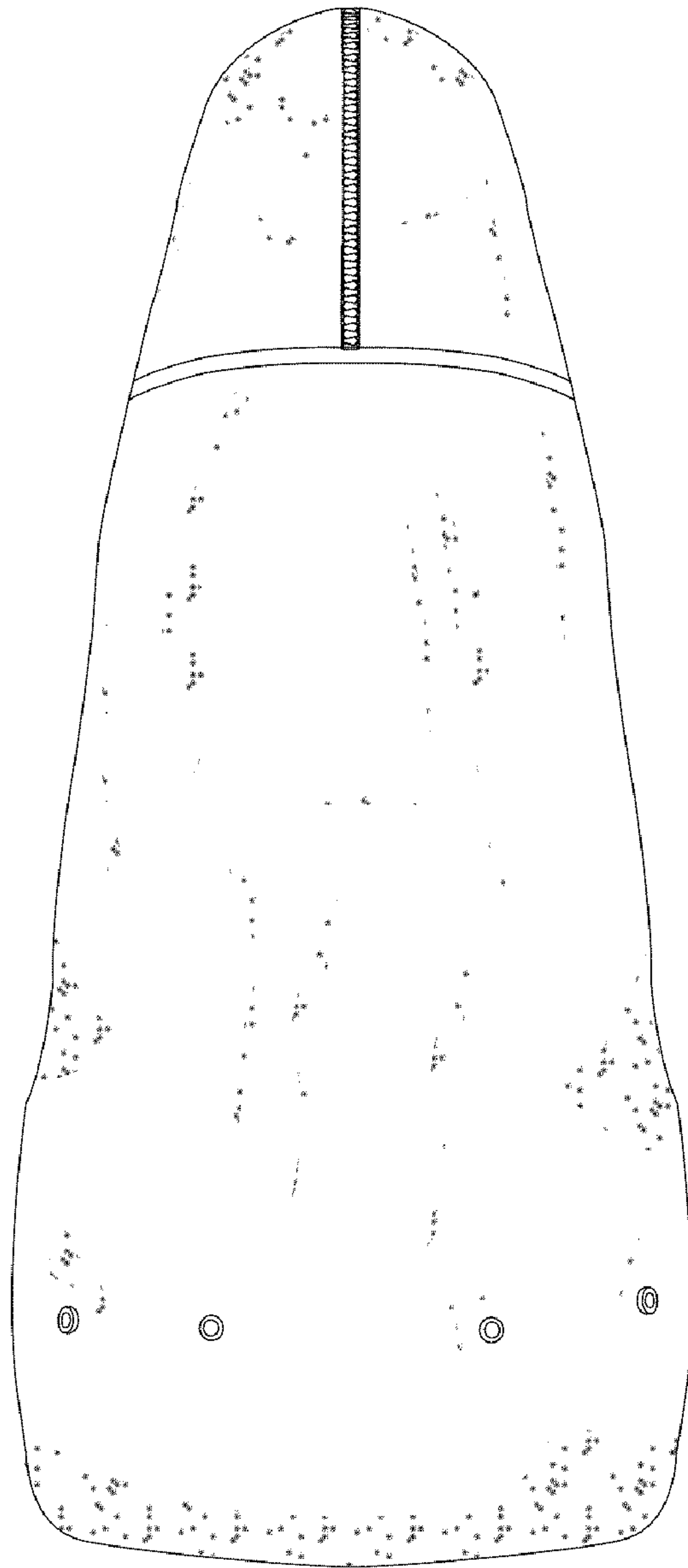

Fig. 3

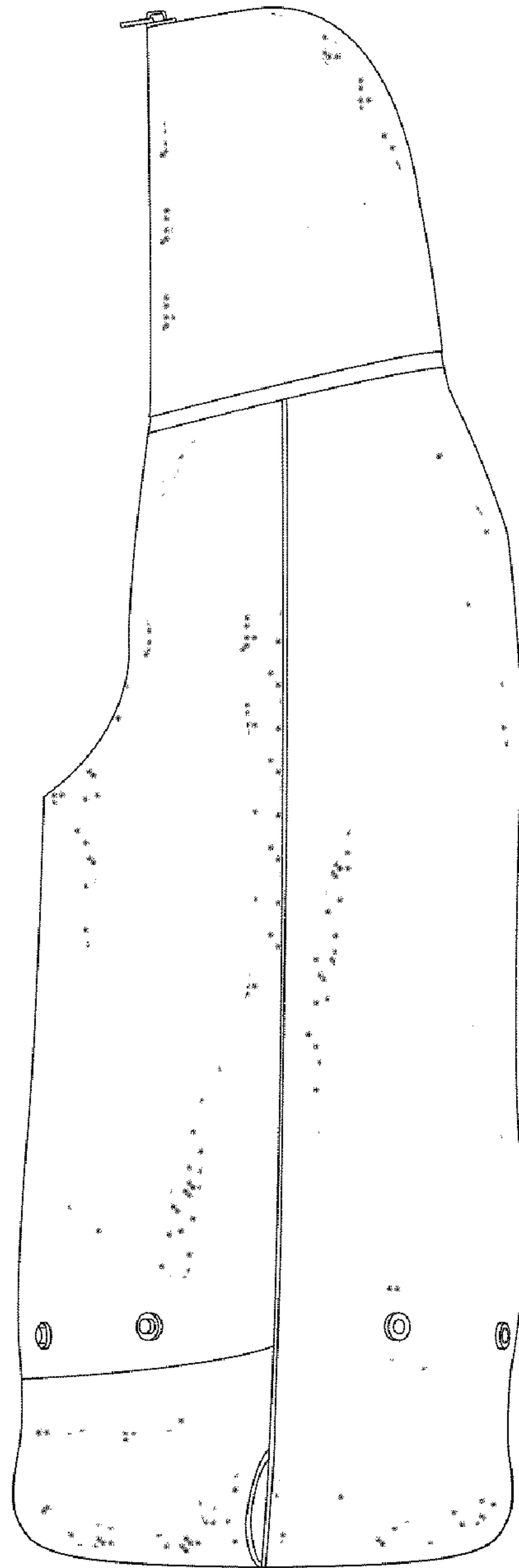

Fig. 4

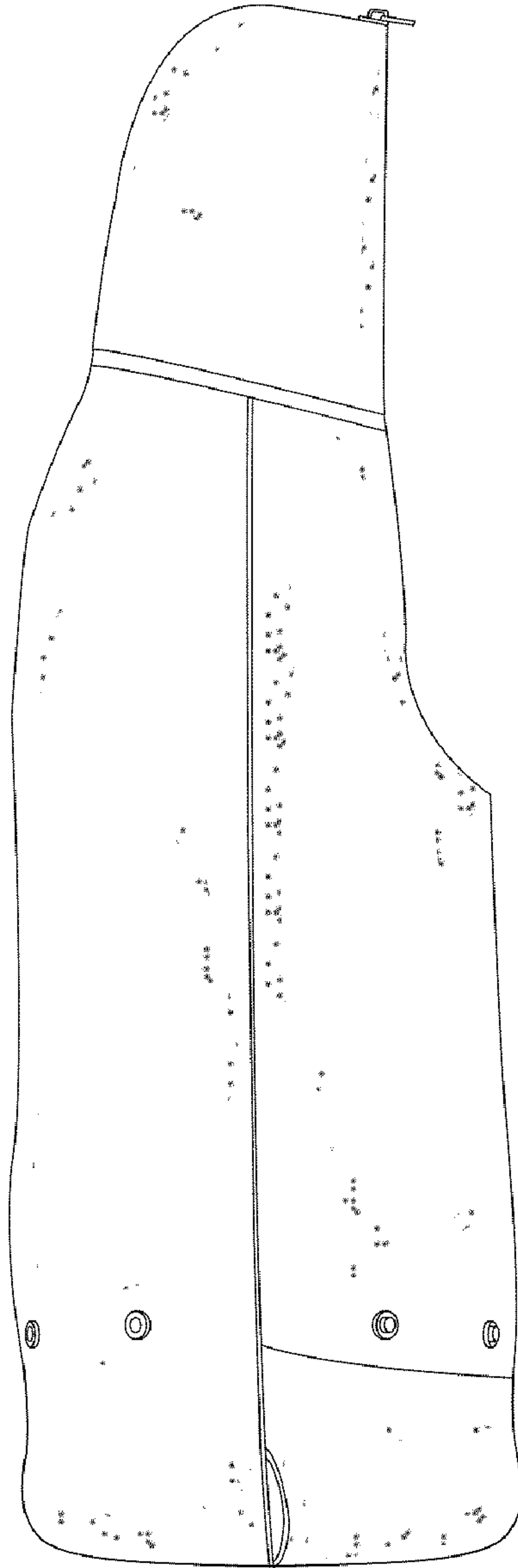

Fig. 5

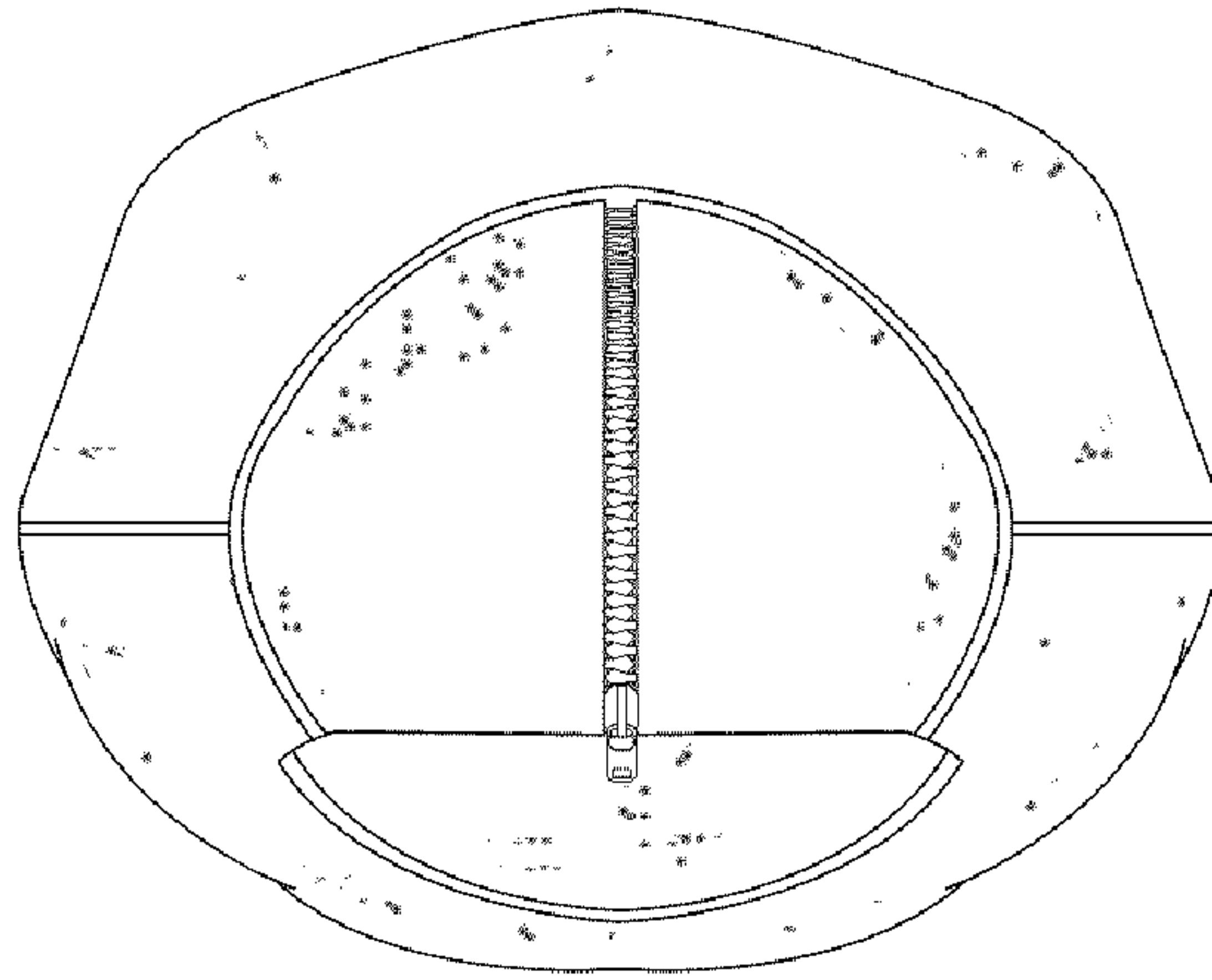

Fig. 6

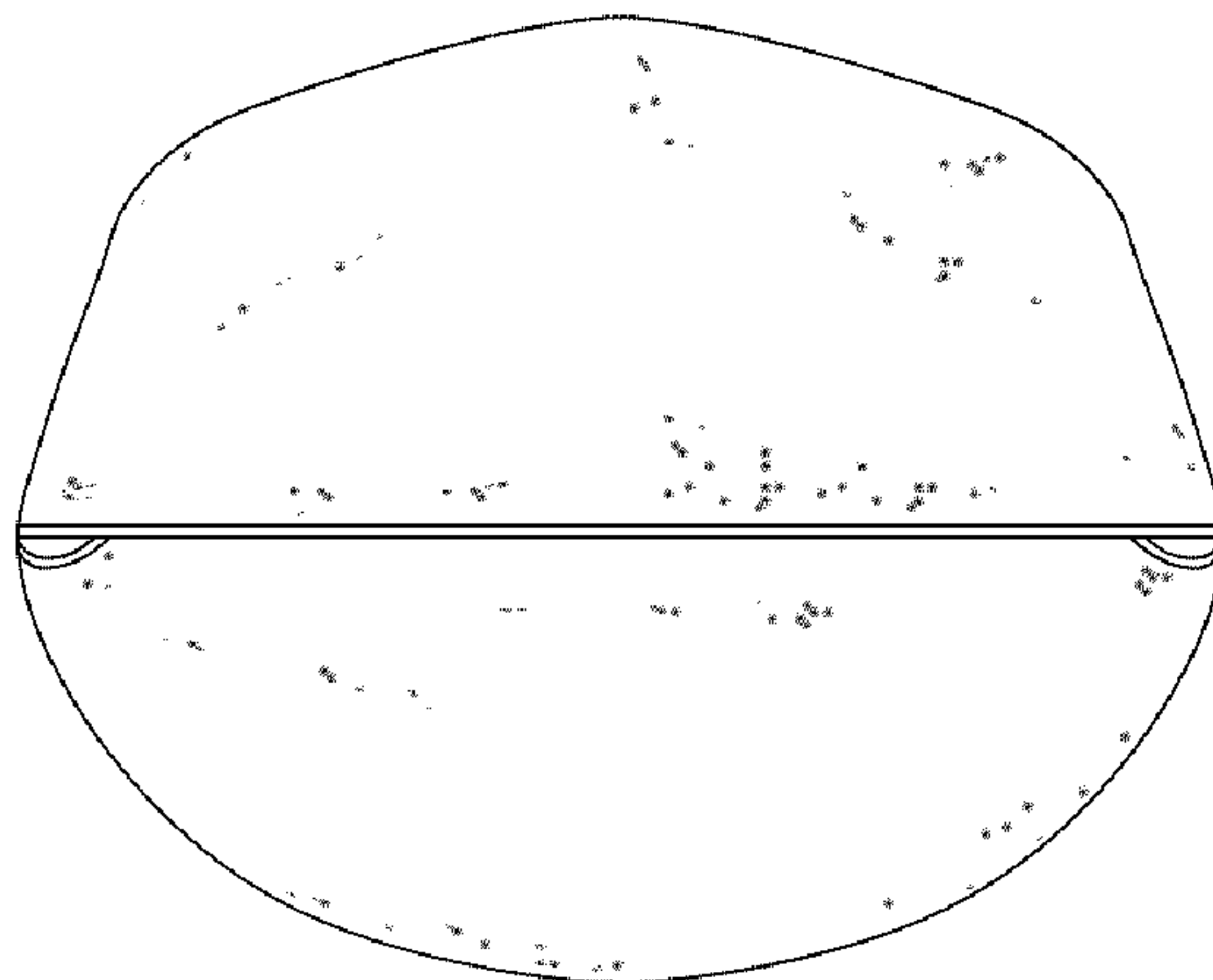

Fig. 7