

US00D652996S

(12) **United States Design Patent**  
**Campbell**

(10) **Patent No.:** **US D652,996 S**

(45) **Date of Patent:** **\*\* Jan. 24, 2012**

(54) **PET HOUSE**

(76) Inventor: **William Michael Campbell,**  
Farmingdale, NJ (US)

(\*\*) Term: **14 Years**

(21) Appl. No.: **29/383,498**

(22) Filed: **Jan. 18, 2011**

(51) **LOC (9) Cl.** ..... **30-02**

(52) **U.S. Cl.** ..... **D30/108**

(58) **Field of Classification Search** ..... D30/108-120,  
D30/161; 119/28.5, 161-170, 482, 496-499,  
119/502, 512-513, 712

See application file for complete search history.

(56) **References Cited**

**U.S. PATENT DOCUMENTS**

2,047,748	A *	7/1936	Schmidt	.....	446/478
D198,779	S	8/1964	Bredon		
3,176,698	A *	4/1965	Warner	.....	135/100
D224,934	S	10/1972	Gilstrap		
D245,190	S	7/1977	Higo		
D246,540	S	11/1977	Burleson		
D254,574	S	3/1980	Schneider		
D315,186	S	3/1991	Peterson		
D326,740	S	6/1992	Barreto, III		
D326,936	S *	6/1992	Moore	.....	D30/108
D327,340	S *	6/1992	Barreto et al.	.....	D30/118
D327,341	S *	6/1992	Barreto et al.	.....	D30/118
D328,162	S *	7/1992	Barreto et al.	.....	D30/118
D342,115	S	12/1993	Petersheim et al.		
D360,709	S	7/1995	Northrop et al.		
D394,920	S *	6/1998	Krizek	.....	D30/118
D426,034	S	5/2000	Faulstich		
D426,679	S	6/2000	Richmond		
D432,738	S *	10/2000	Mueller	.....	D30/108
D511,027	S *	10/2005	Mueller	.....	D30/118

D518,243	S	3/2006	Weidner
D557,865	S	12/2007	Link
D581,251	S	11/2008	Bucci
D583,517	S	12/2008	Tycer

\* cited by examiner

*Primary Examiner* — T. Chase Nelson

*Assistant Examiner* — Ania Aman

(74) *Attorney, Agent, or Firm* — QuickPatents, Inc.; Kevin Prince

(57) **CLAIM**

The ornamental design for a pet house, as shown and described.

**DESCRIPTION**

FIG. 1 is a perspective view of a pet house, showing a first embodiment of the new design;

FIG. 2 is a front elevational view thereof;

FIG. 3 is a right-side elevational view thereof;

FIG. 4 is a left-side elevational view thereof;

FIG. 5 is a rear elevational view thereof;

FIG. 6 is a top plan view thereof;

FIG. 7 is a bottom plan view thereof;

FIG. 8 is a front elevational view of a second embodiment thereof;

FIG. 9 is a rear elevational view of FIG. 8;

FIG. 10 is a right-side elevational view of FIG. 8;

FIG. 11 is a left-side elevational view of FIG. 8;

FIG. 12 is a top plan view of FIG. 8; and,

FIG. 13 is a bottom plan view of FIG. 8.

The broken lines showing a logo and graphics applied to the design and ground stakes in FIG. 1 are included for the purpose of illustrating the invention in use, and form no part of the claimed design.

**1 Claim, 6 Drawing Sheets**

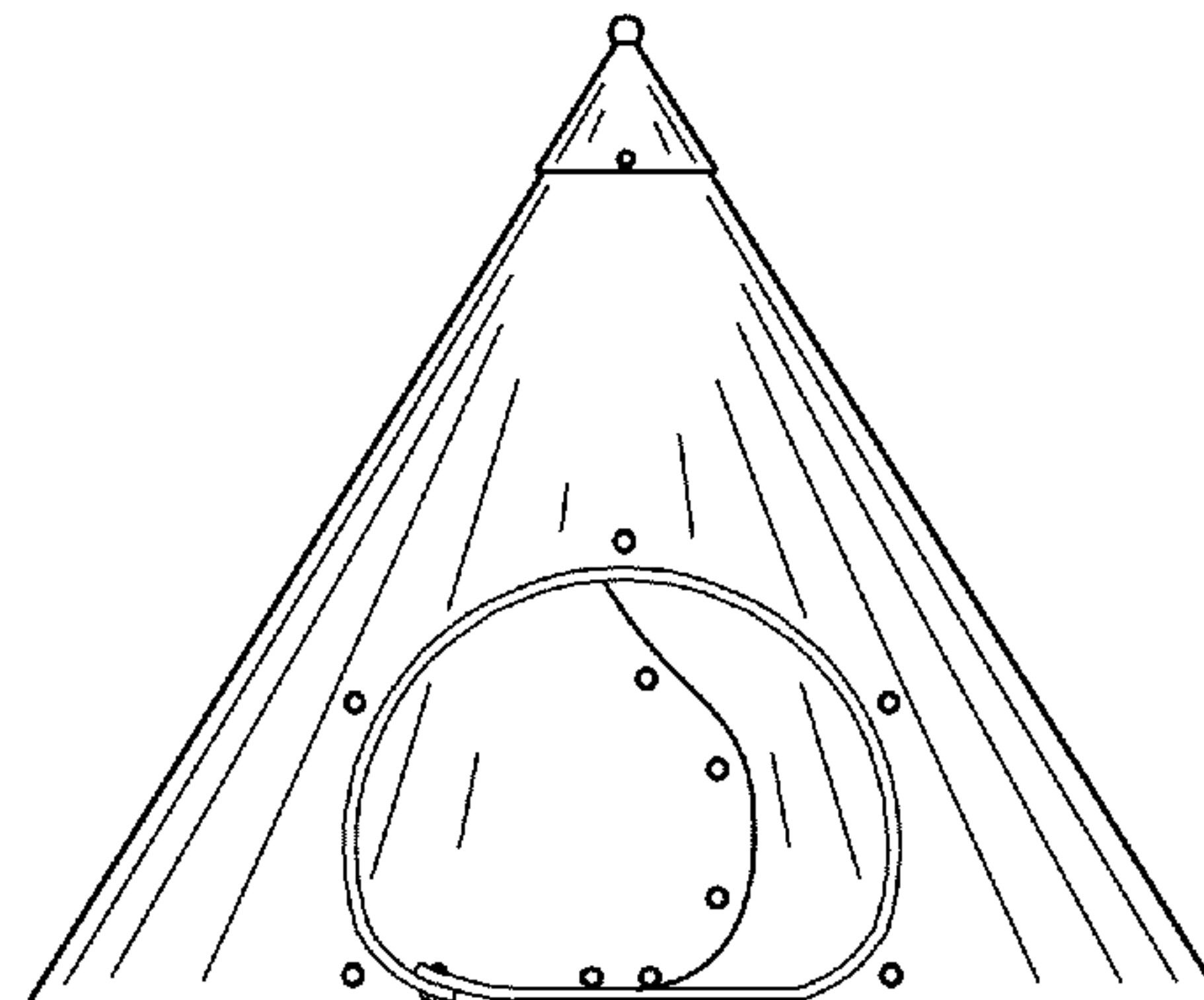
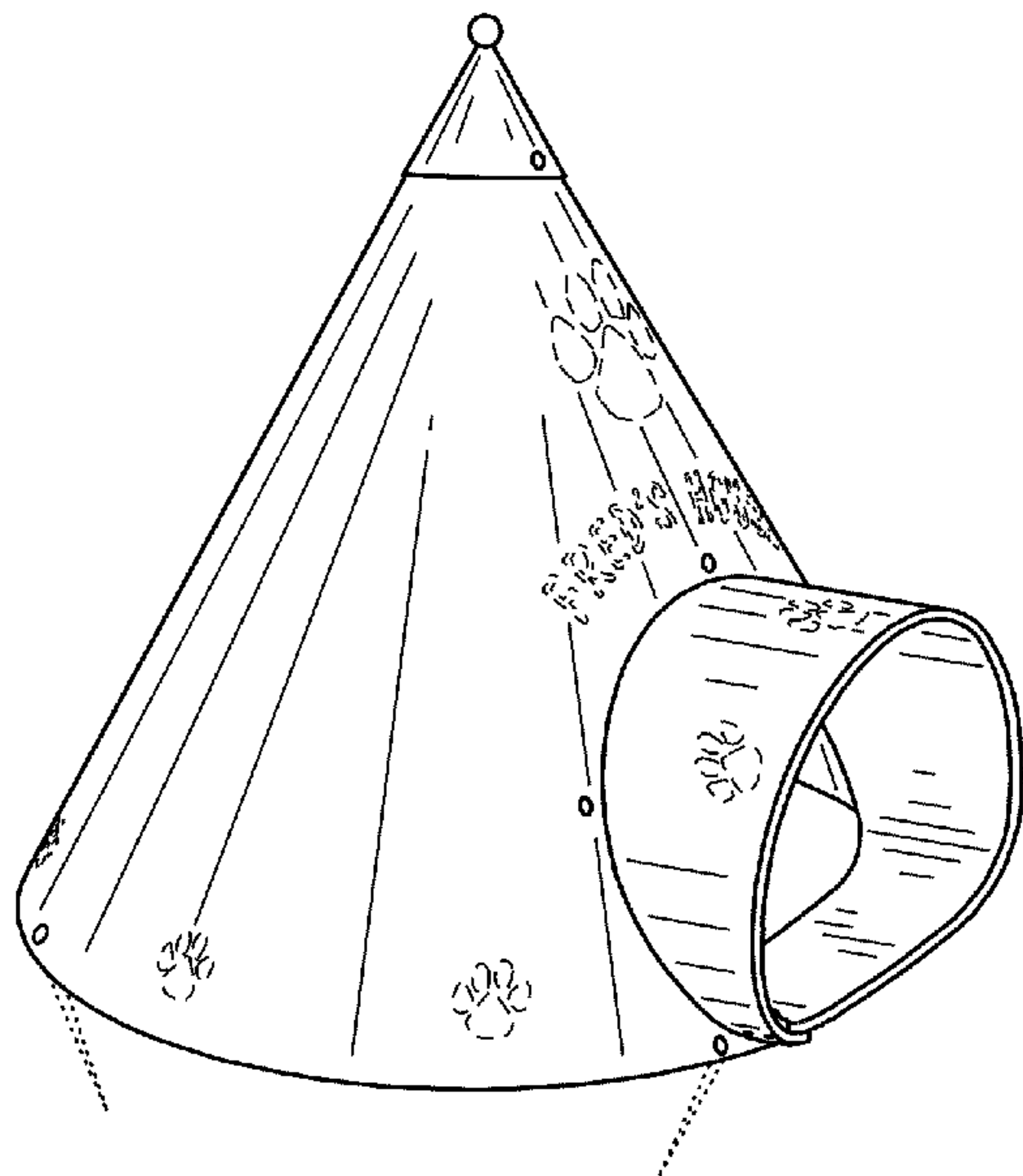

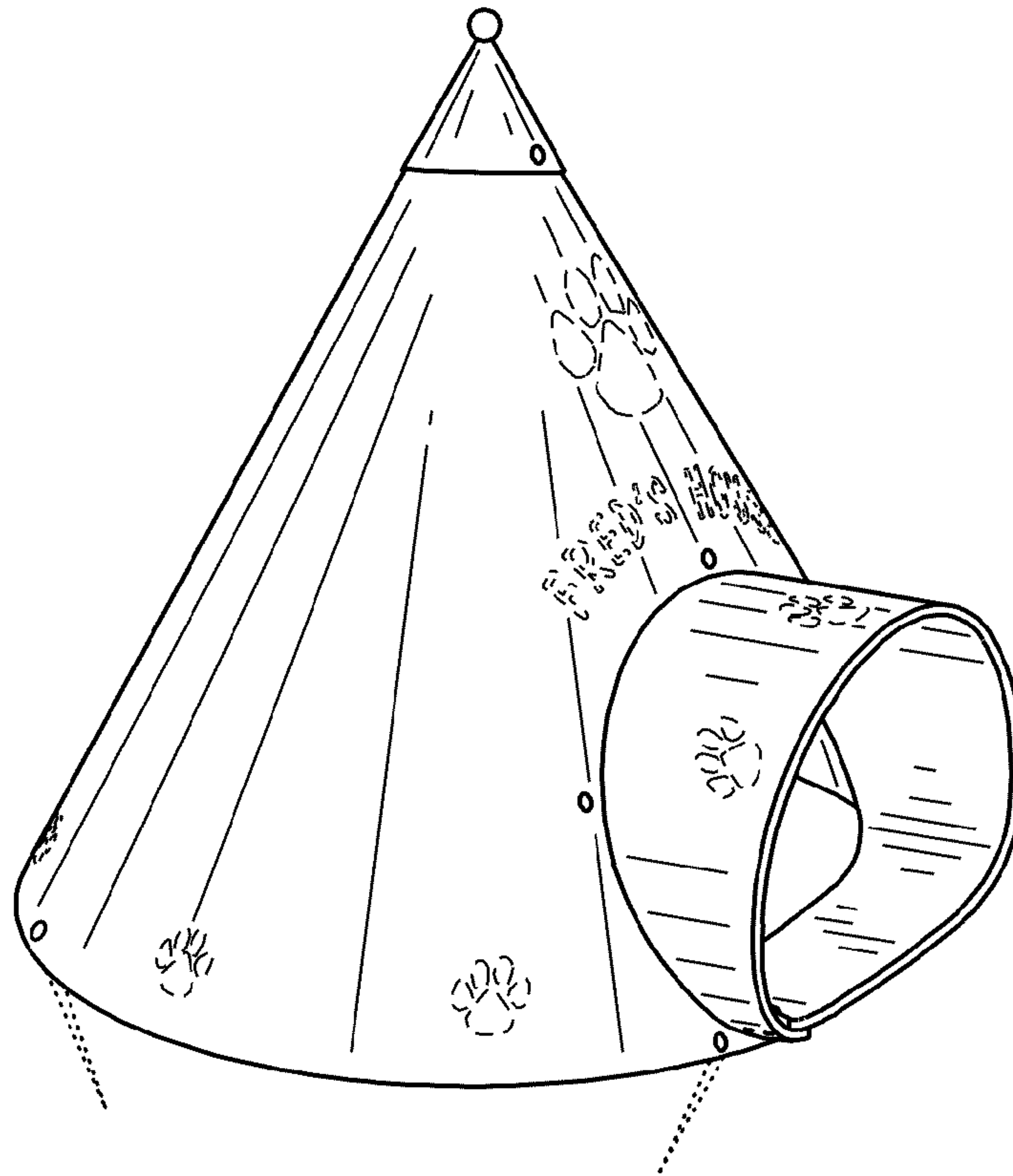

FIG. 1

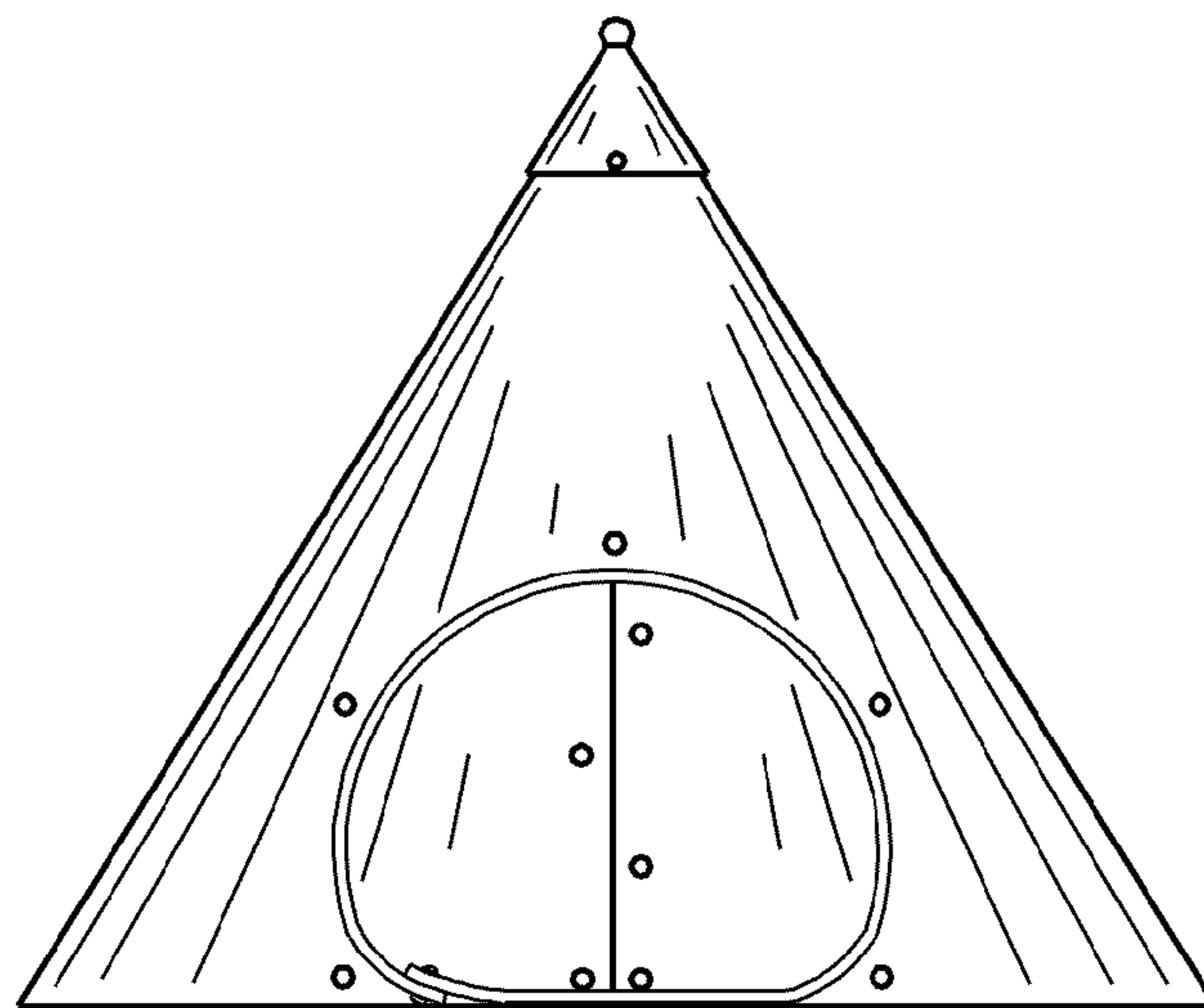

FIG. 2

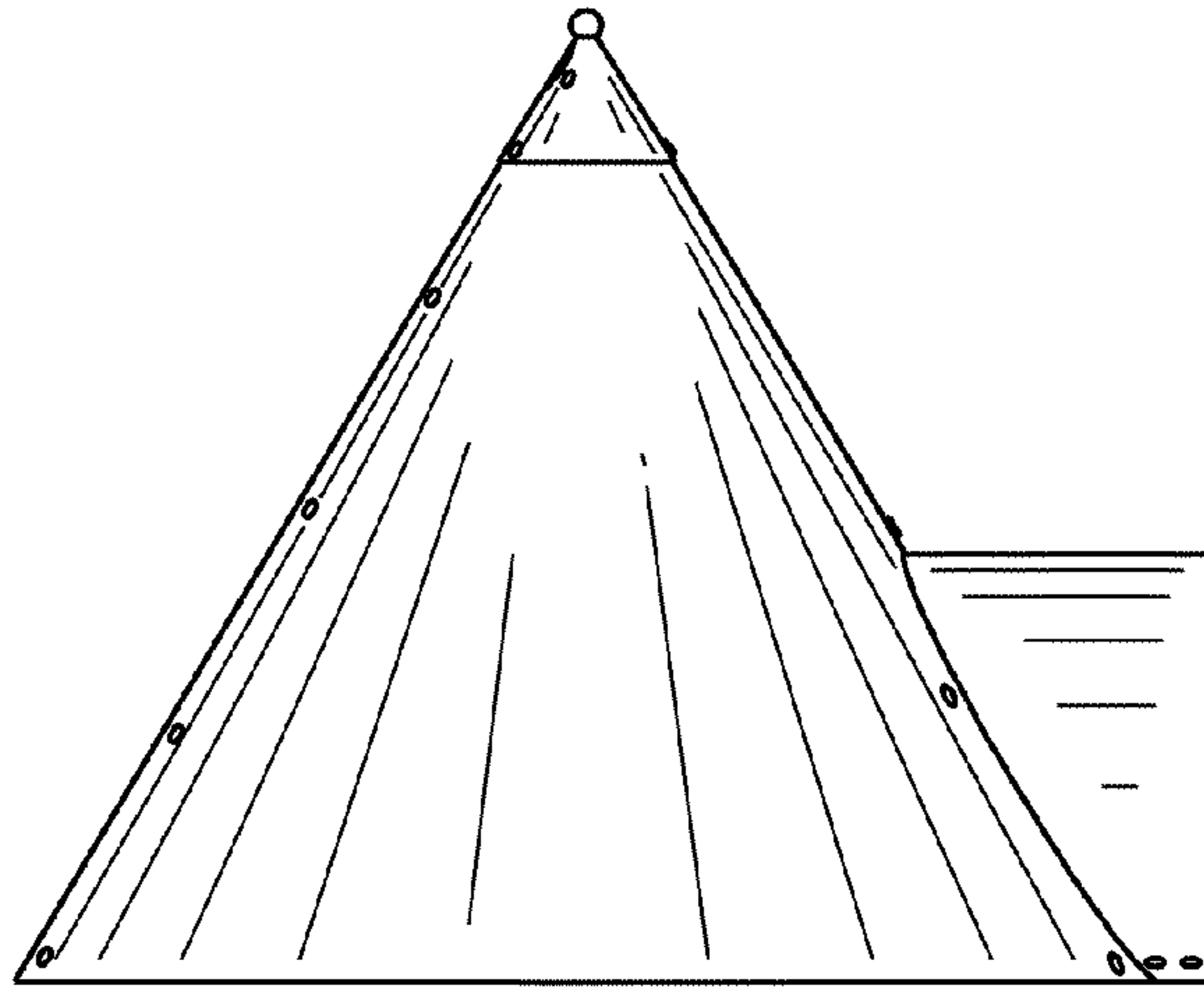

FIG. 3

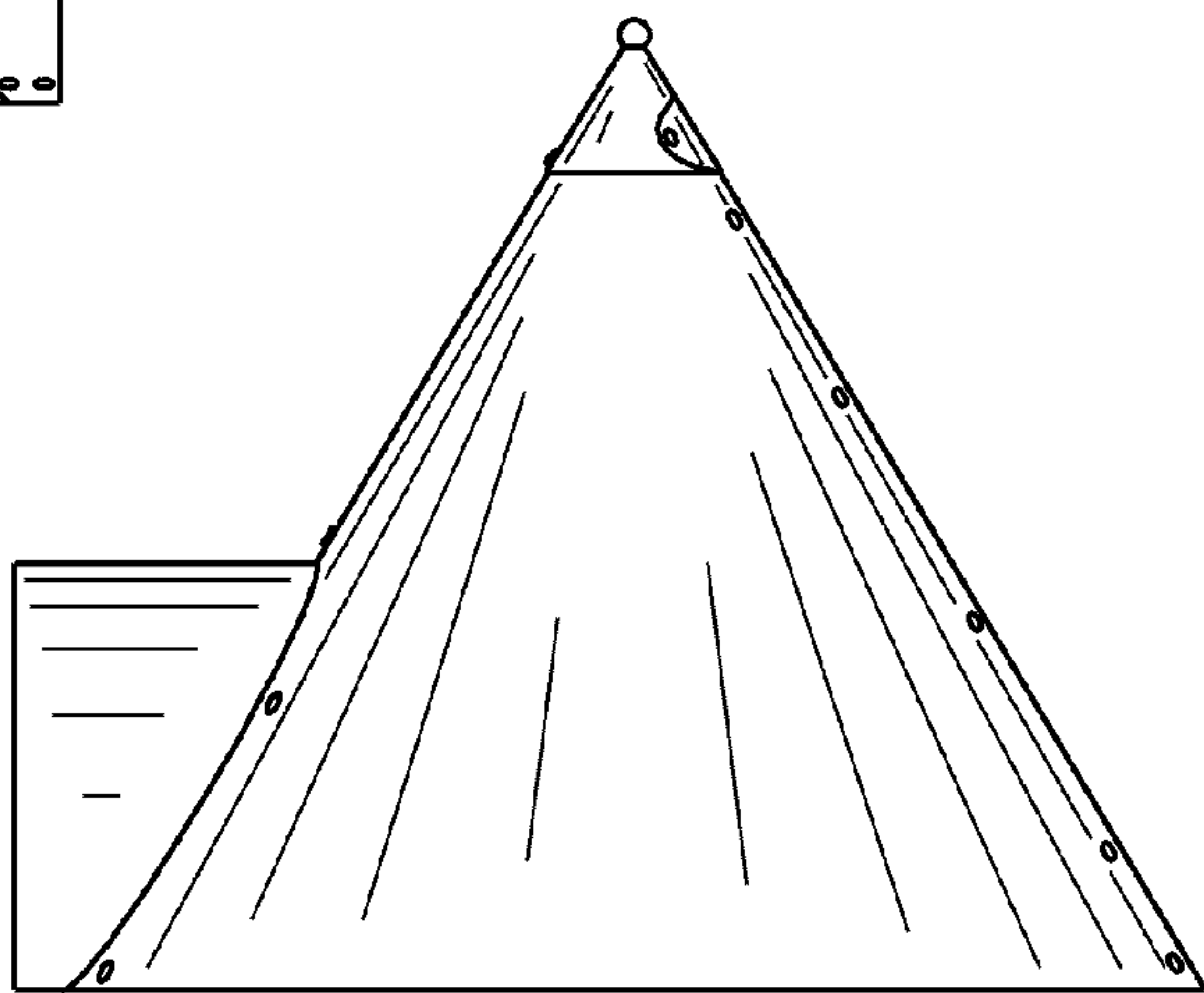

FIG. 4

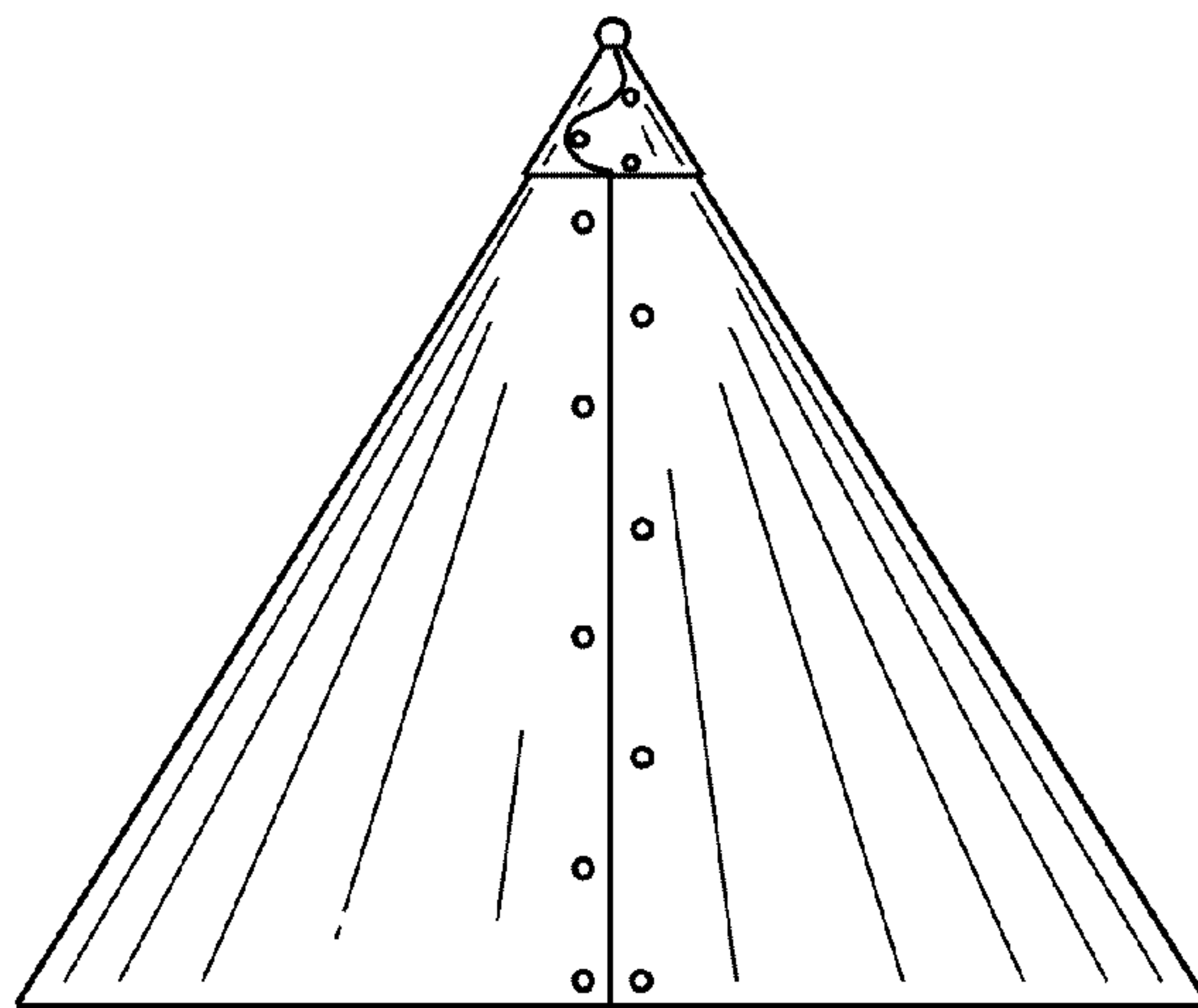

FIG. 5

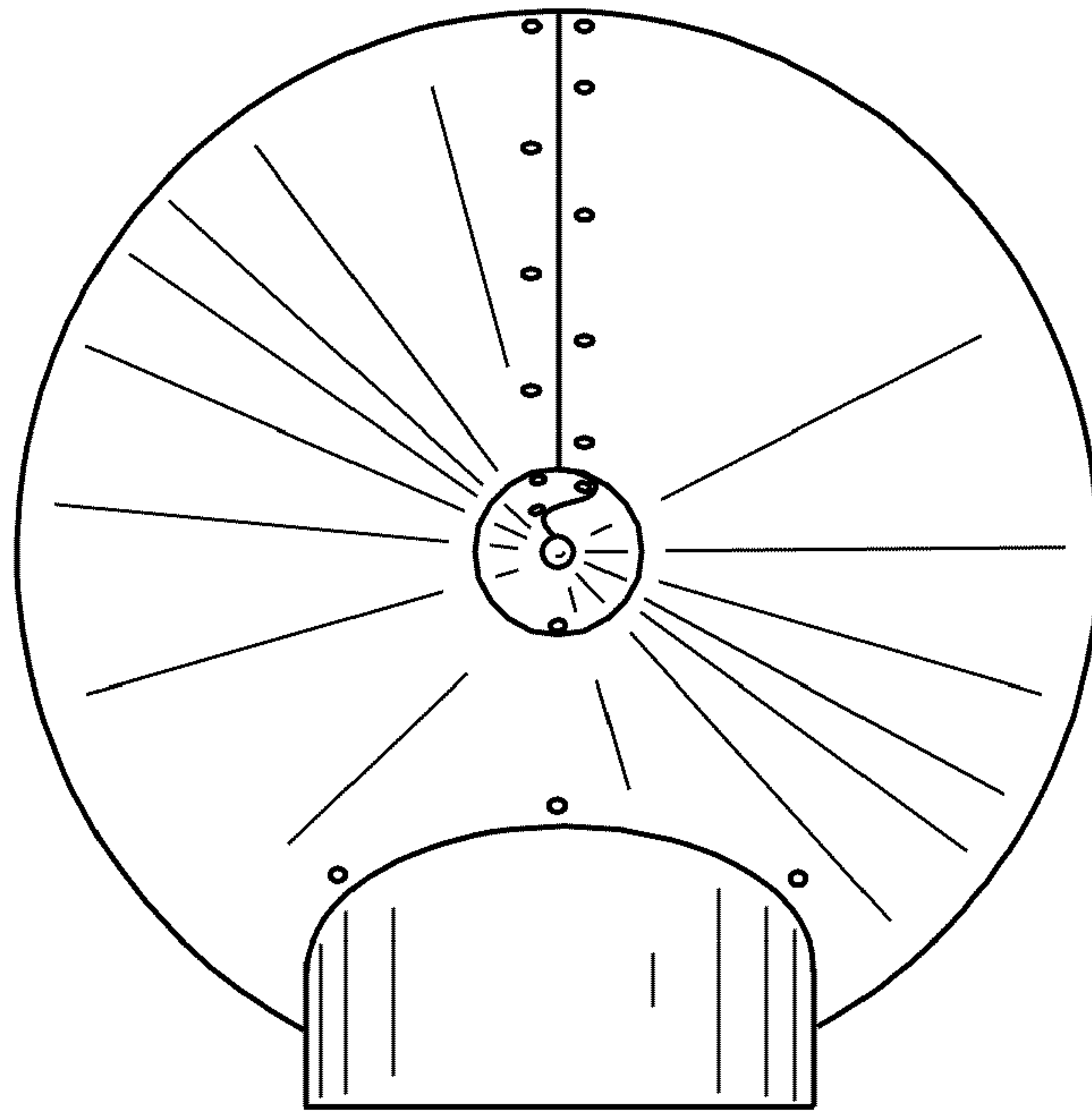

FIG. 6

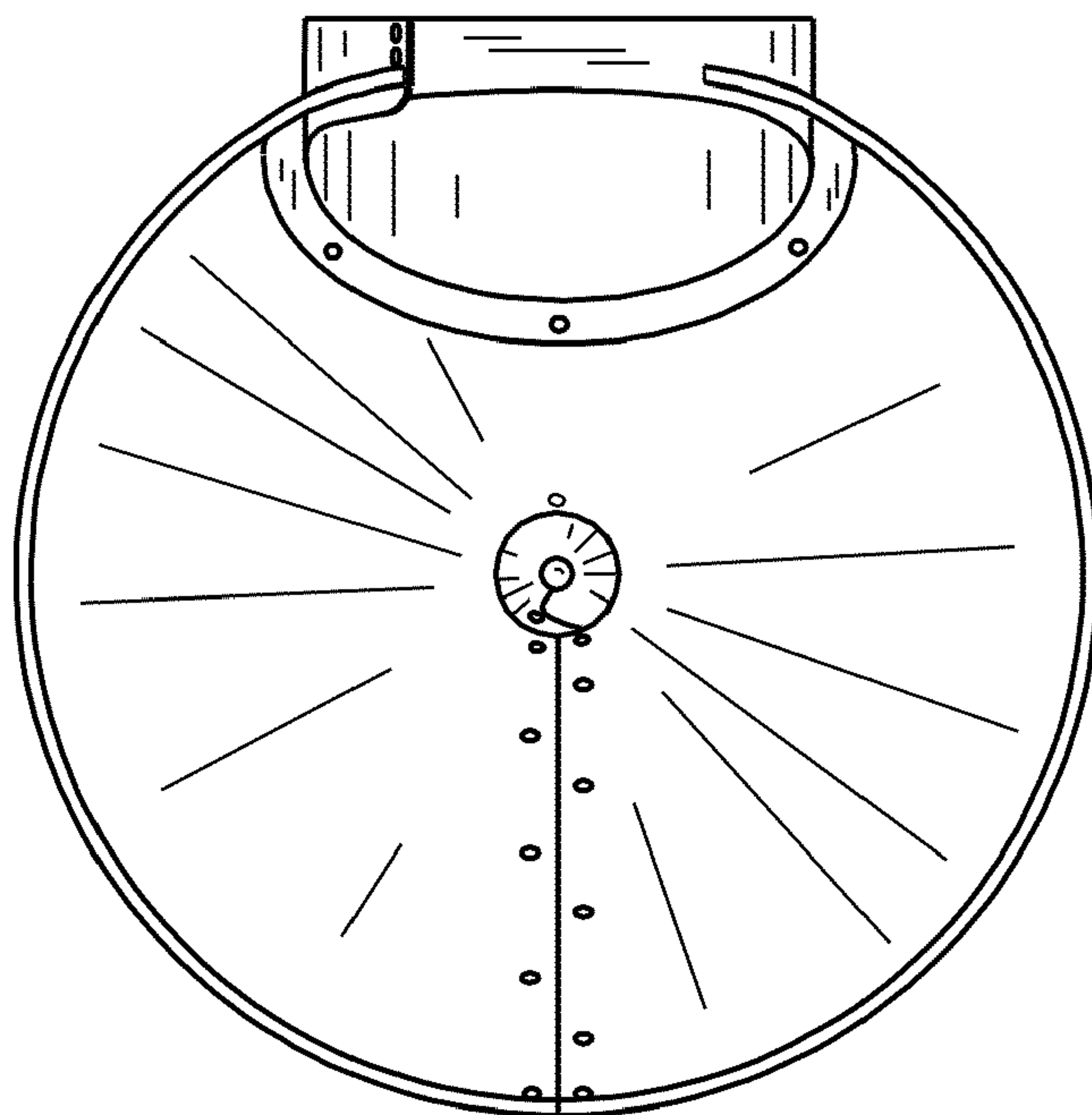

FIG. 7



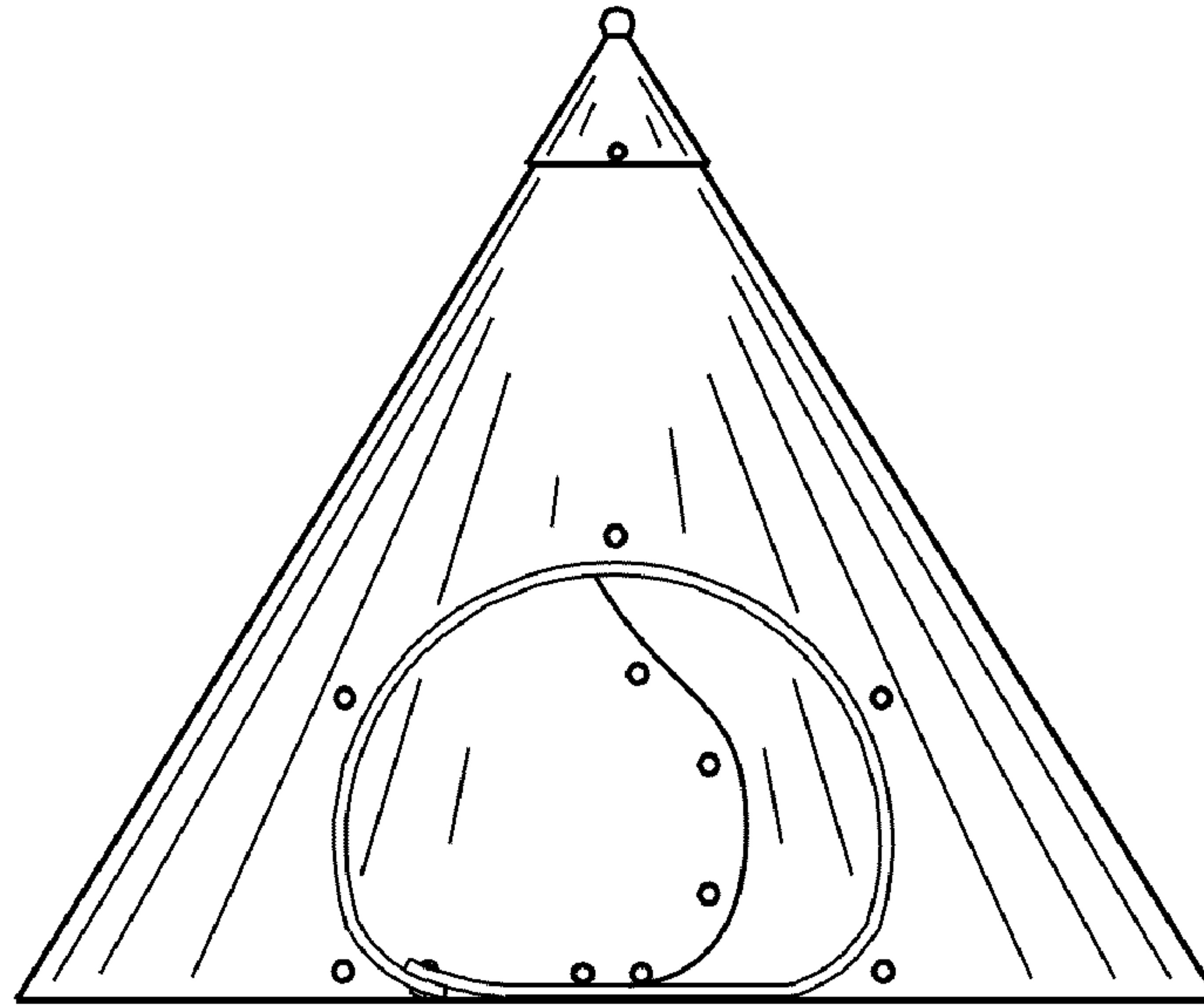

FIG. 8

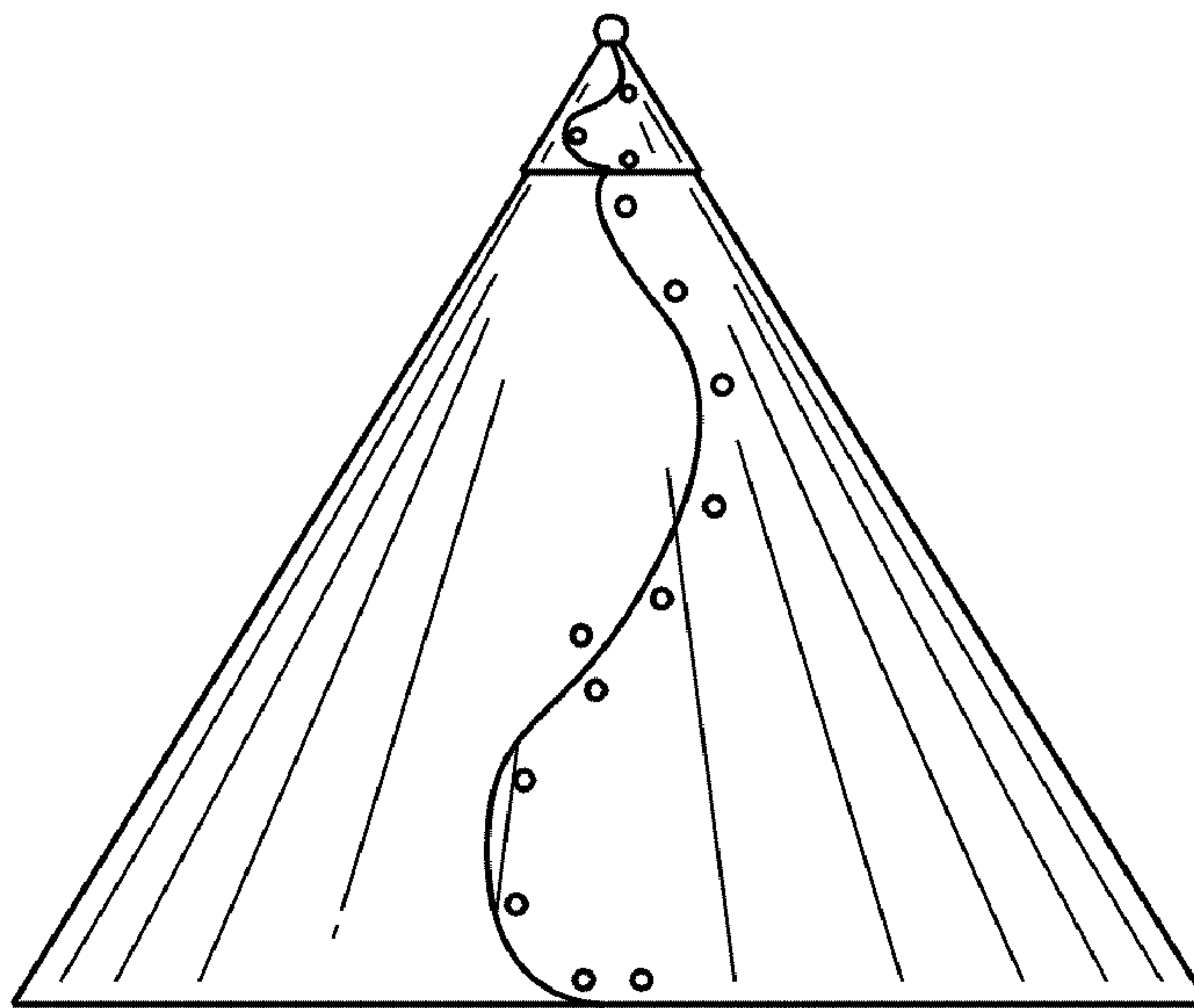

FIG. 9

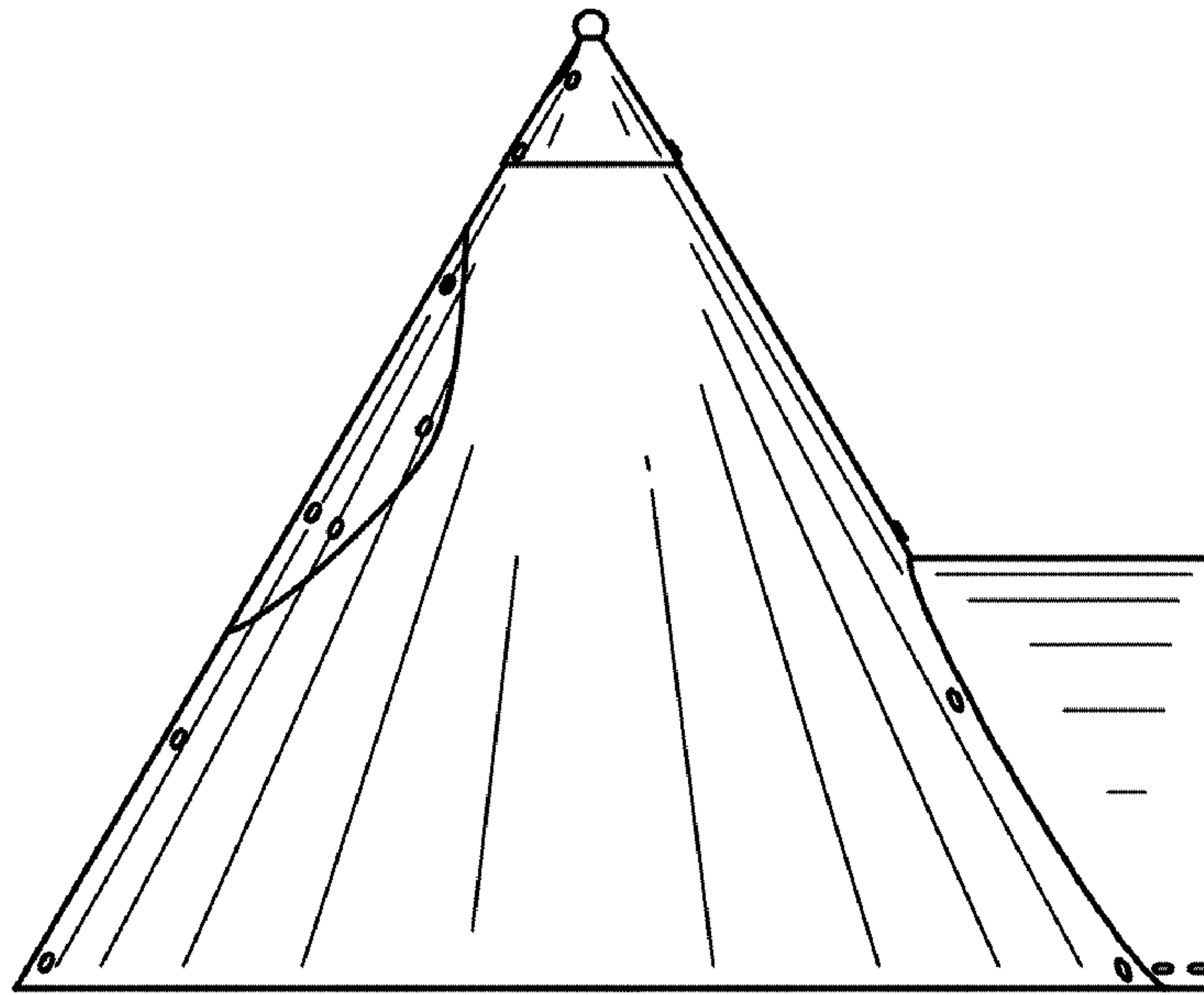

FIG. 10

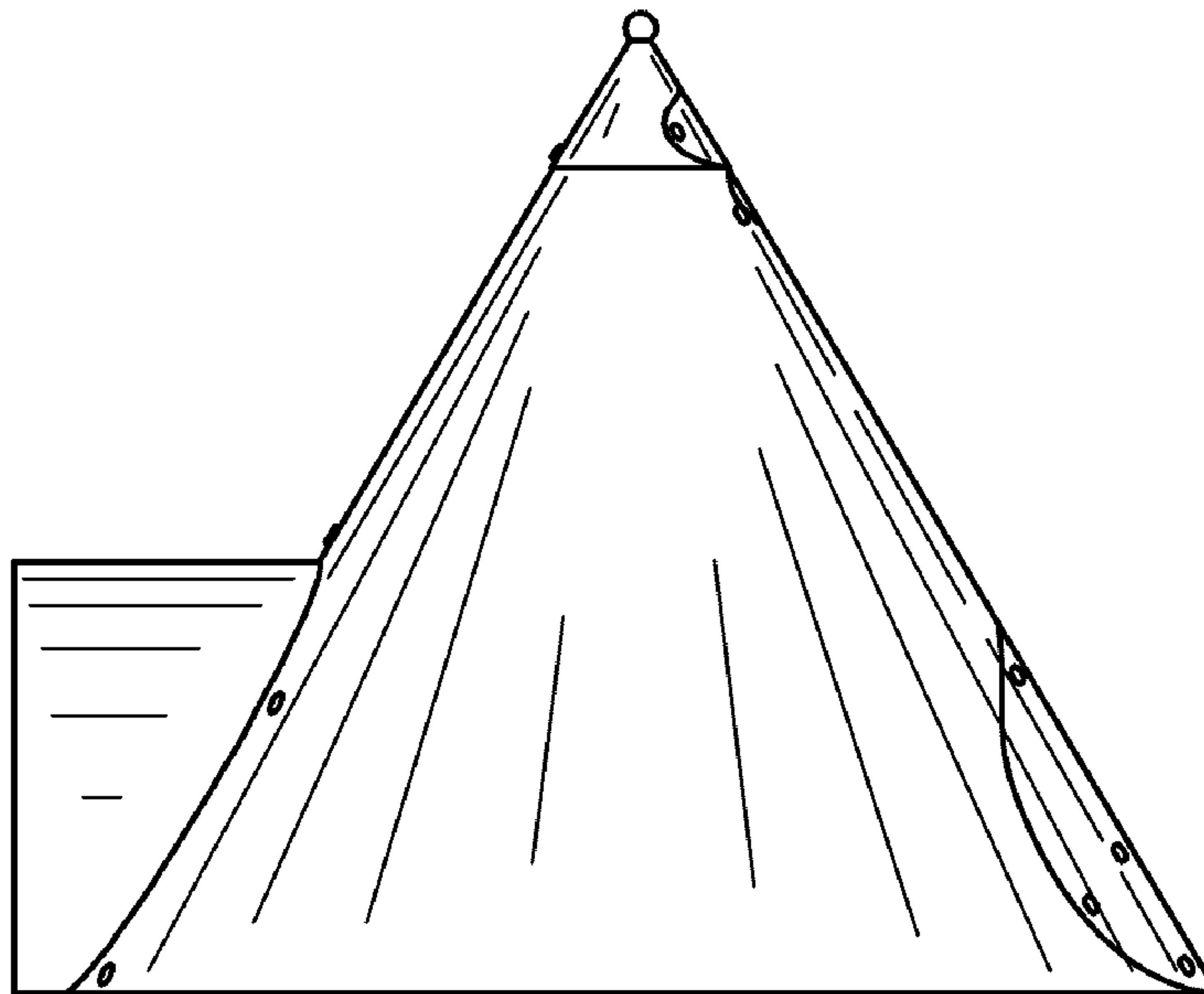

FIG. 11

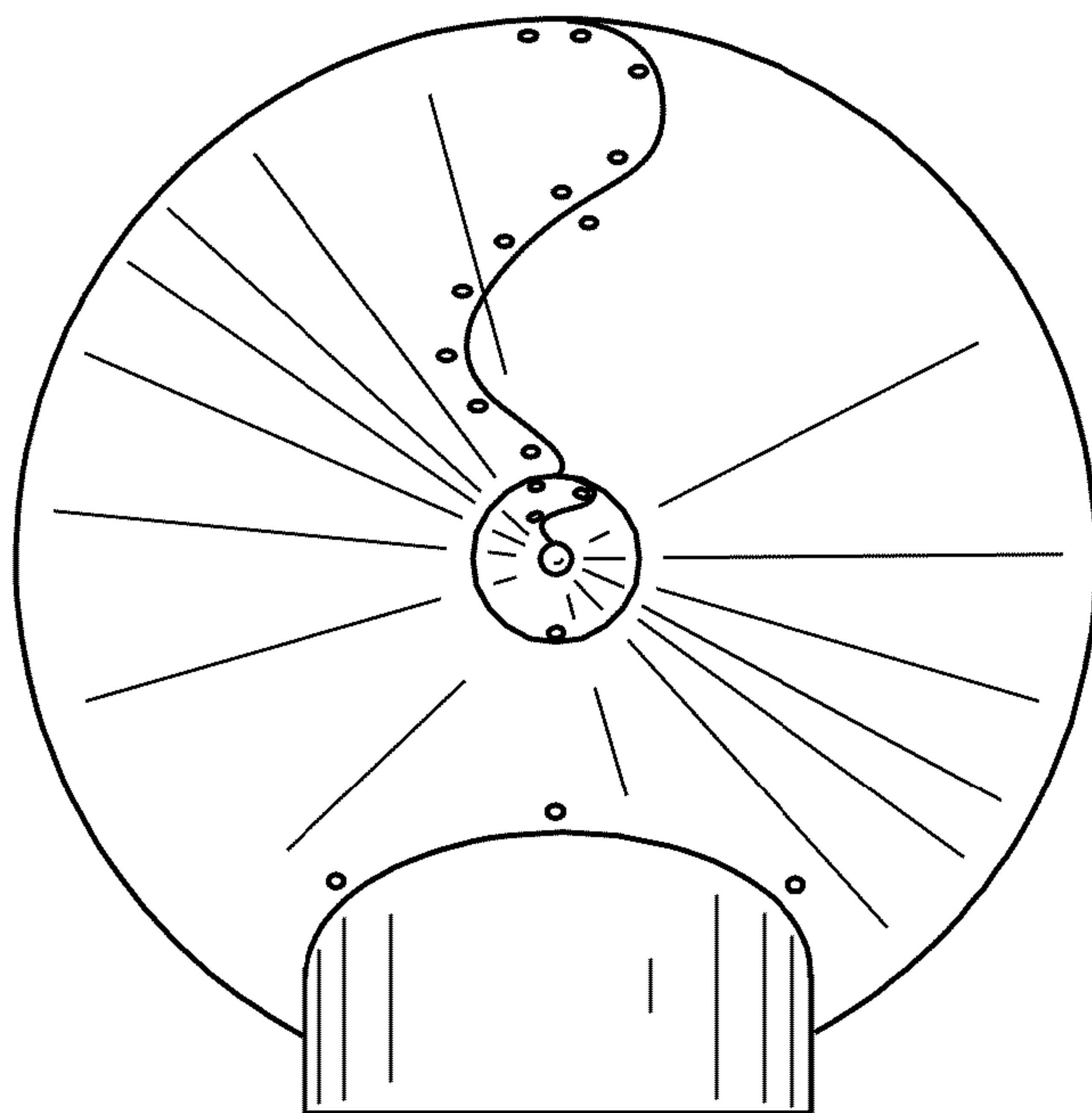

FIG. 12

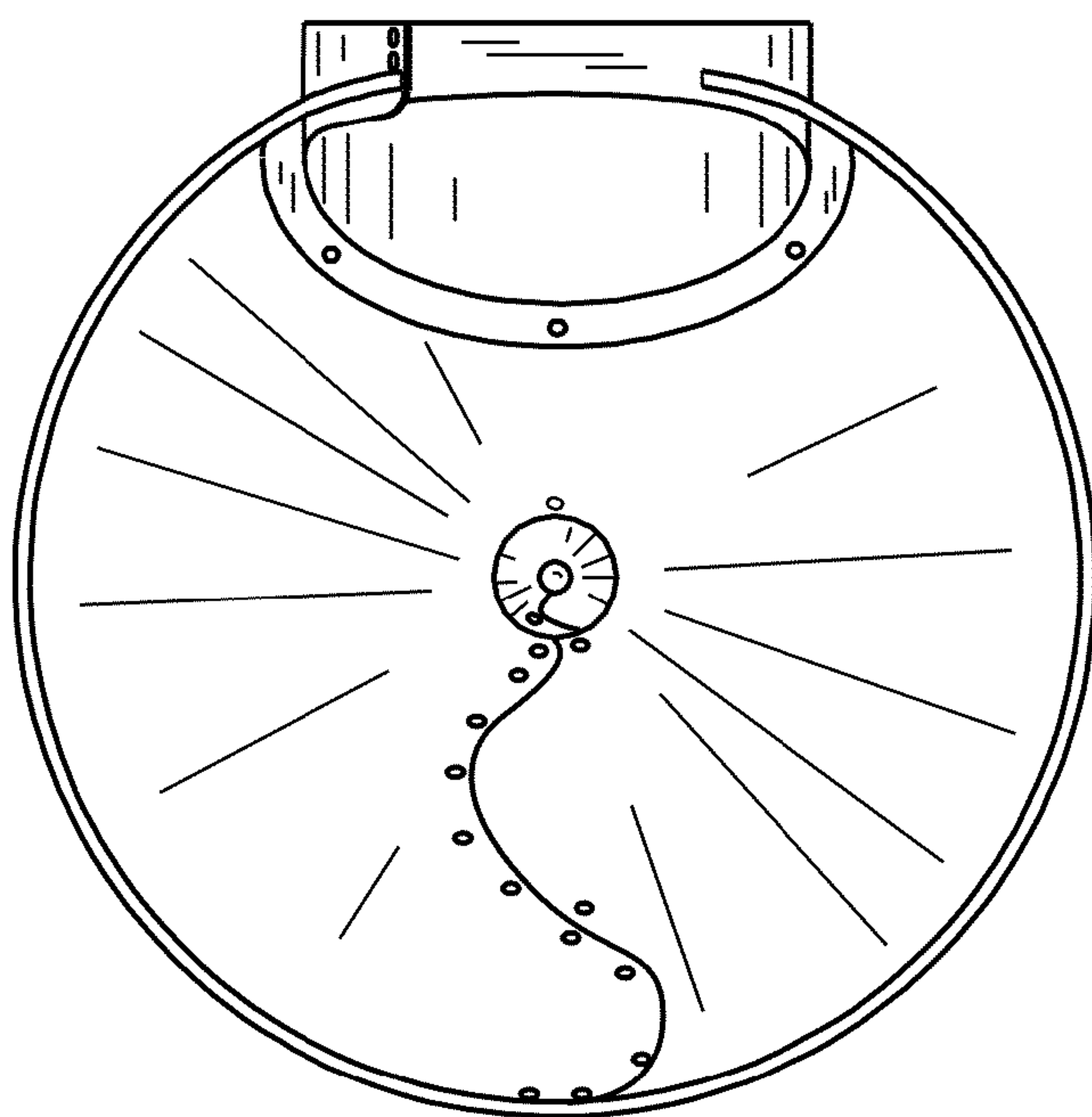

FIG. 13