

US00D652990S

(12) **United States Design Patent**
Strickland

(10) **Patent No.:** **US D652,990 S**

(45) **Date of Patent:** **** Jan. 24, 2012**

(54) **MULTI-PURPOSE SHAVING APPARATUS**

(76) Inventor: **Andy G. Strickland**, Seminole, FL (US)

(**) Term: **14 Years**

(21) Appl. No.: **29/391,340**

(22) Filed: **May 6, 2011**

(51) **LOC (9) Cl.** **28-03**

(52) **U.S. Cl.** **D28/46; D28/50; D28/53**

(58) **Field of Classification Search** D28/44,
D28/44.1-54; 30/32, 34.05, 34.1, 34.2, 43,
30/42, 44-61, 77-84, 526-541

See application file for complete search history.

(56) **References Cited**

U.S. PATENT DOCUMENTS

D568,534 S *	5/2008	Micinilio et al.	D28/46
D571,954 S *	6/2008	Kling et al.	D28/46
D591,451 S *	4/2009	Micinilio et al.	D28/46

D600,408 S *	9/2009	Micinilio et al.	D28/46
D604,906 S *	11/2009	Stowers et al.	D28/48
D629,159 S *	12/2010	Yoon	D28/46

* cited by examiner

Primary Examiner — Jennifer Rivard

(74) *Attorney, Agent, or Firm* — Thomas Frost

(57) **CLAIM**

The ornamental design for a multi-purpose shaving apparatus, as shown and described.

DESCRIPTION

FIG. 1 is a top perspective view of a multi-purpose shaving apparatus with a trimmer in open position;

FIG. 2 is a top perspective view of the multi-purpose shaving apparatus with the trimmer in closed position.

FIG. 3 is a bottom plan view of the multi-purpose shaving apparatus.

FIG. 4 is a front elevational view of FIG. 2.

FIG. 5 is a rear elevational view of FIG. 2.

FIG. 6 is a left view of FIG. 2; and,

FIG. 7 is a right view of FIG. 2.

1 Claim, 5 Drawing Sheets

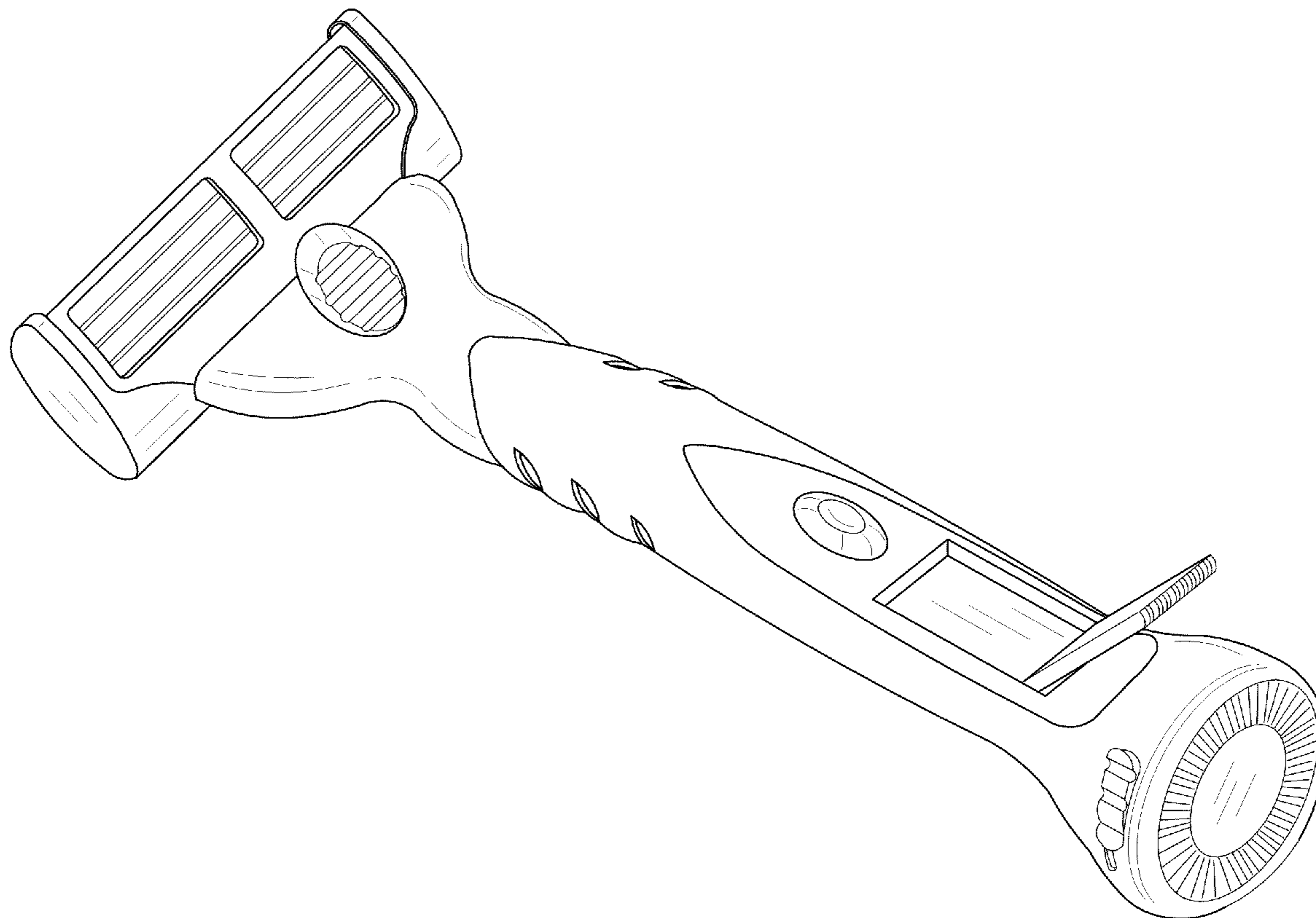

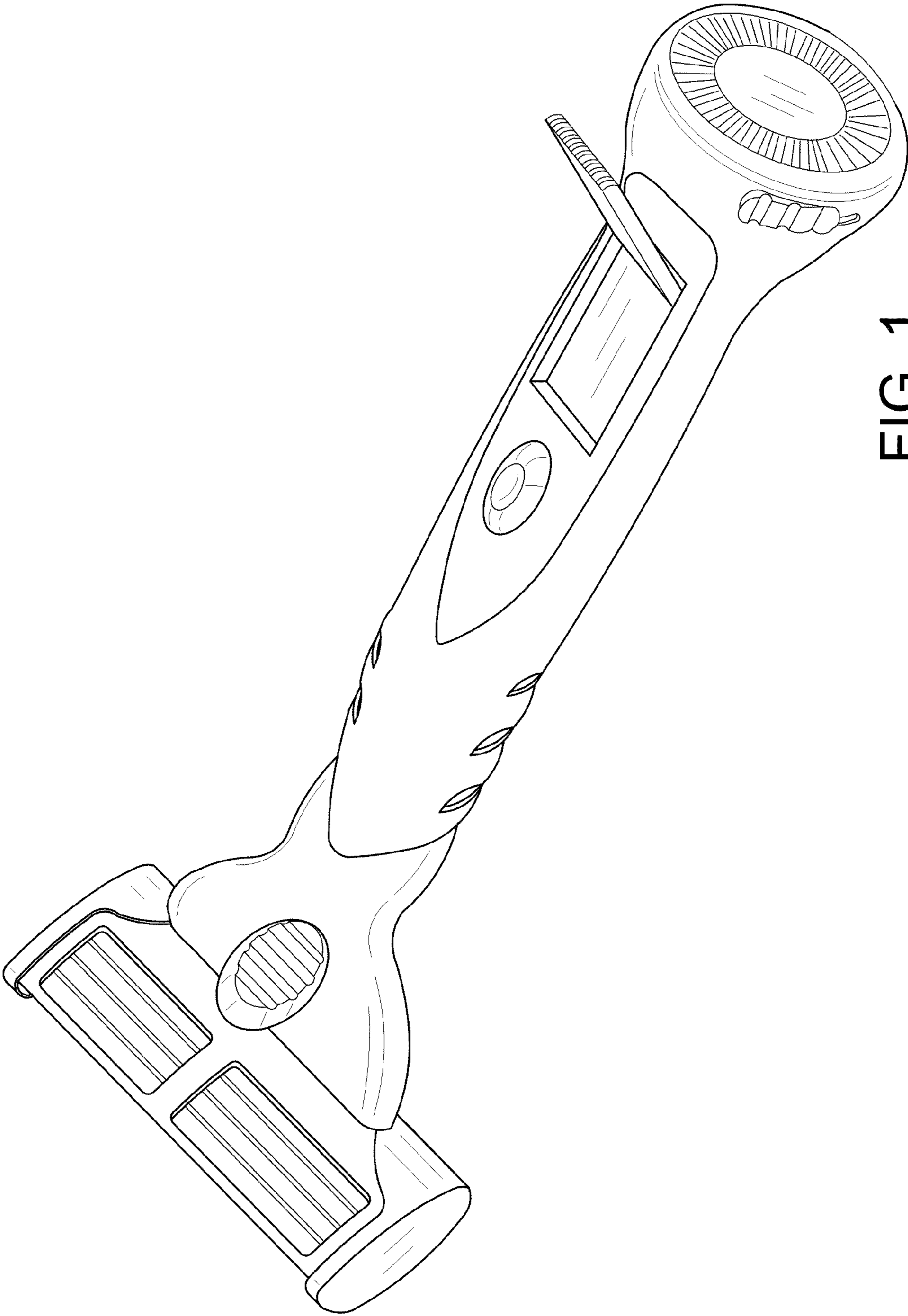

FIG. 1

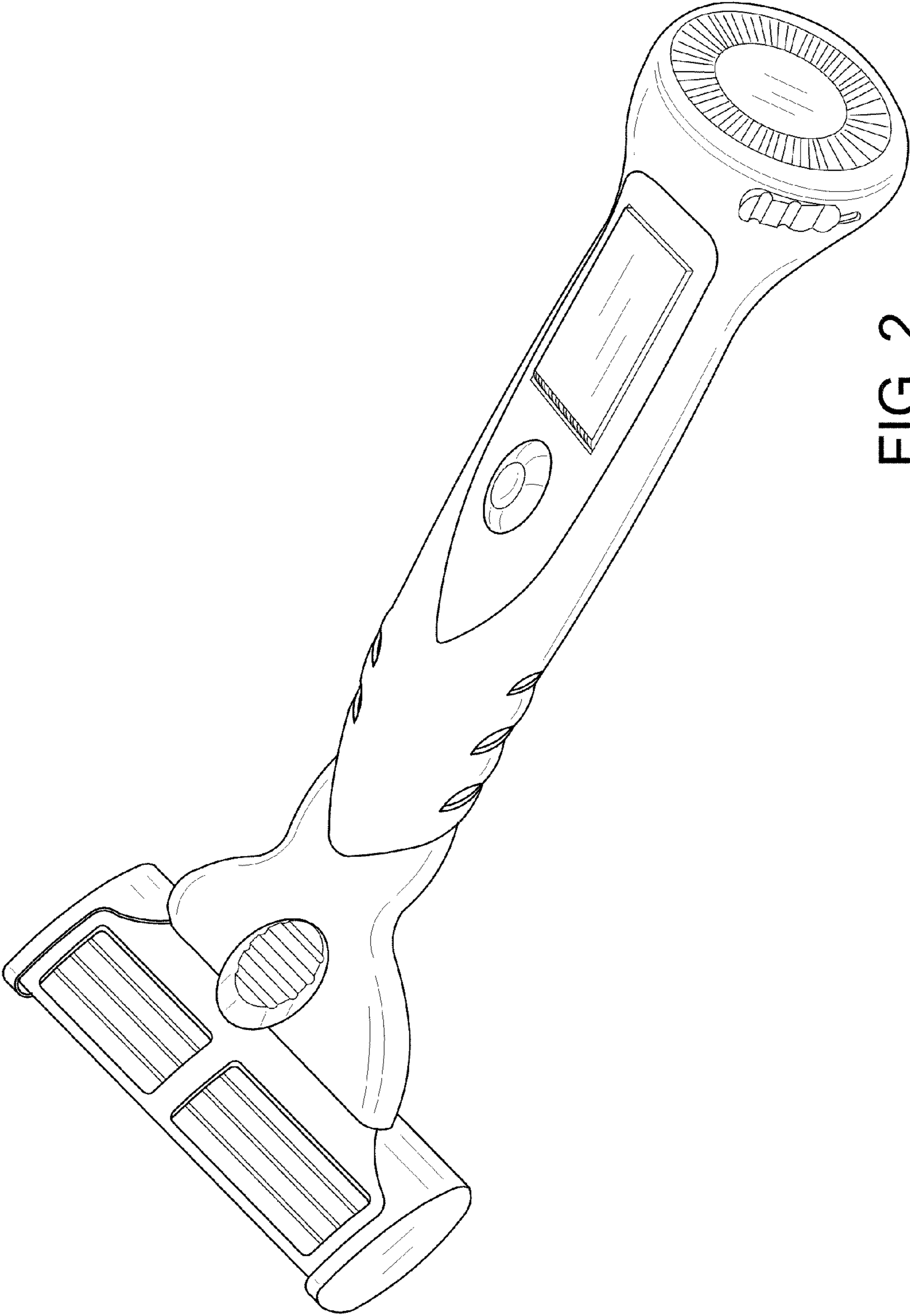

FIG. 2

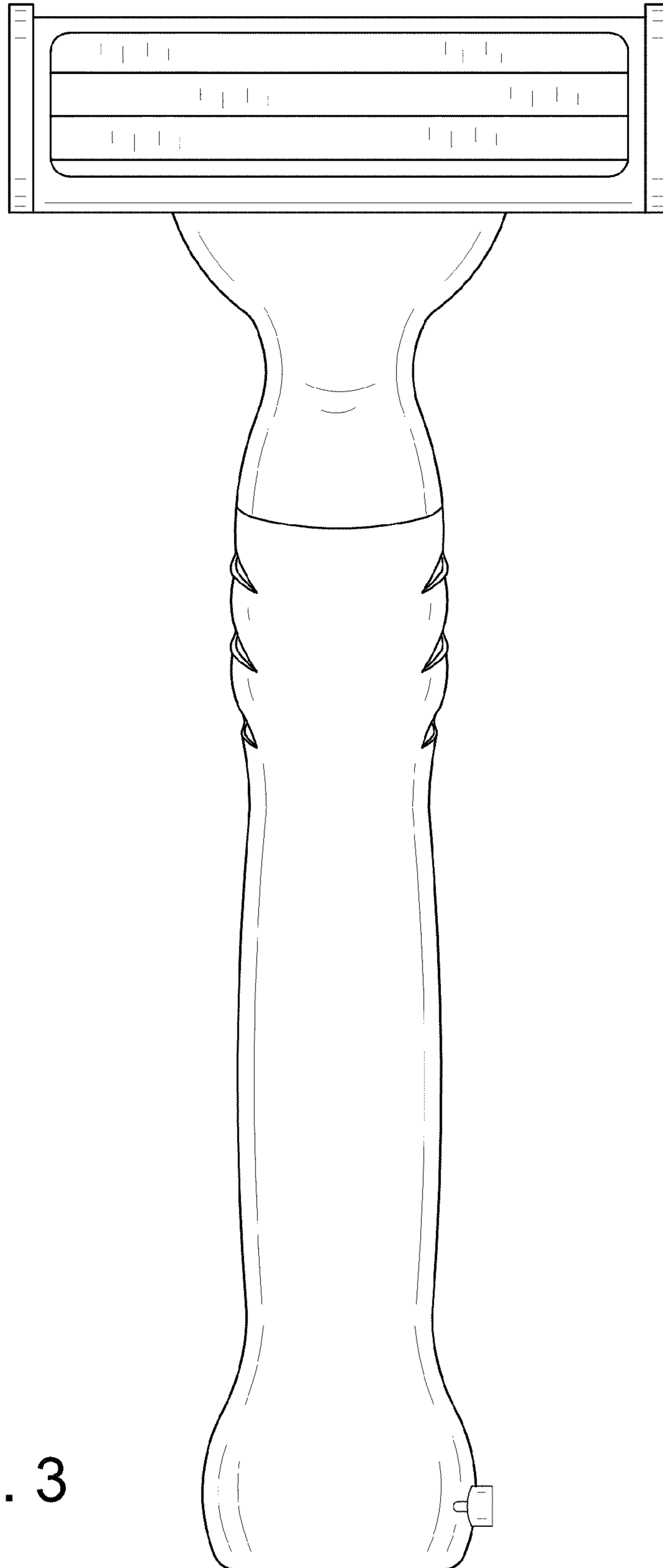

FIG. 3

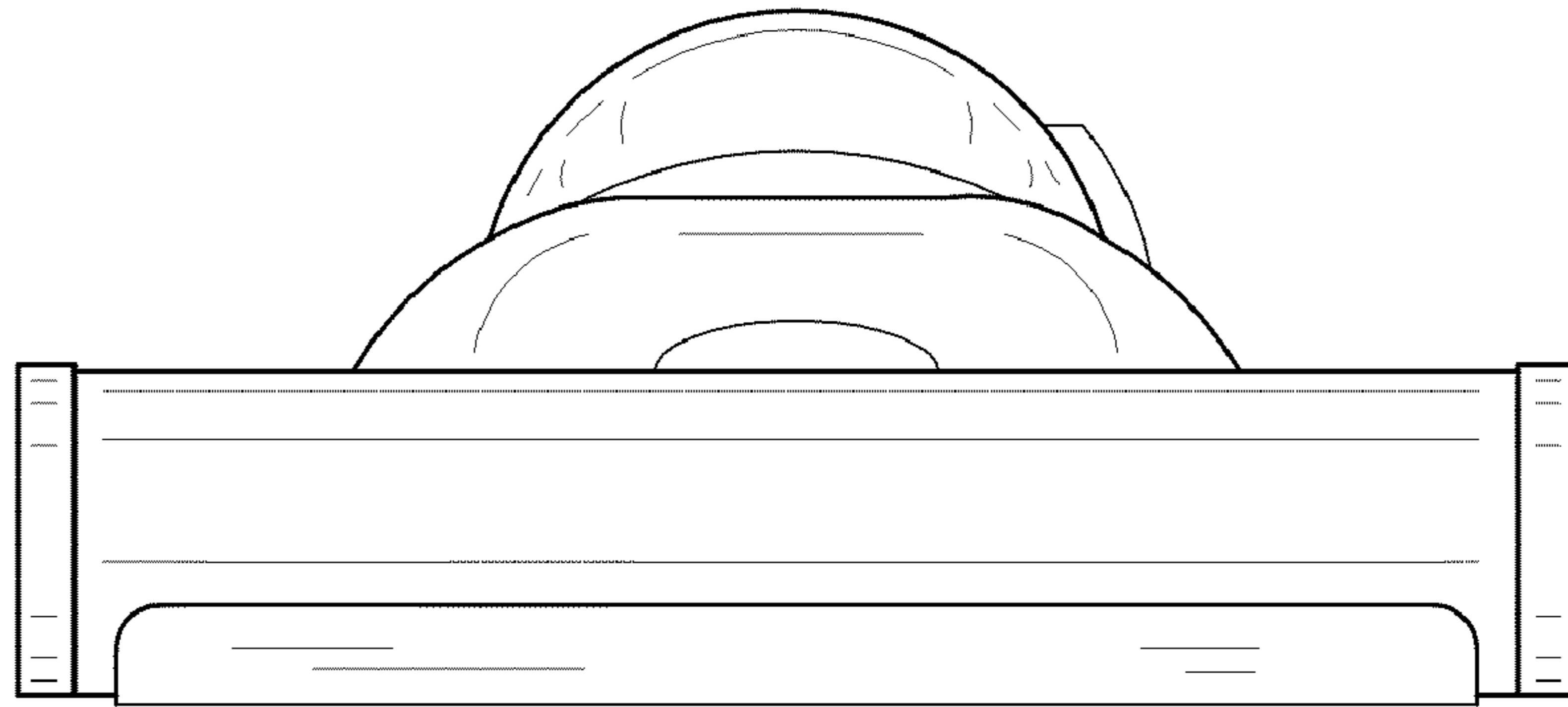

FIG. 4

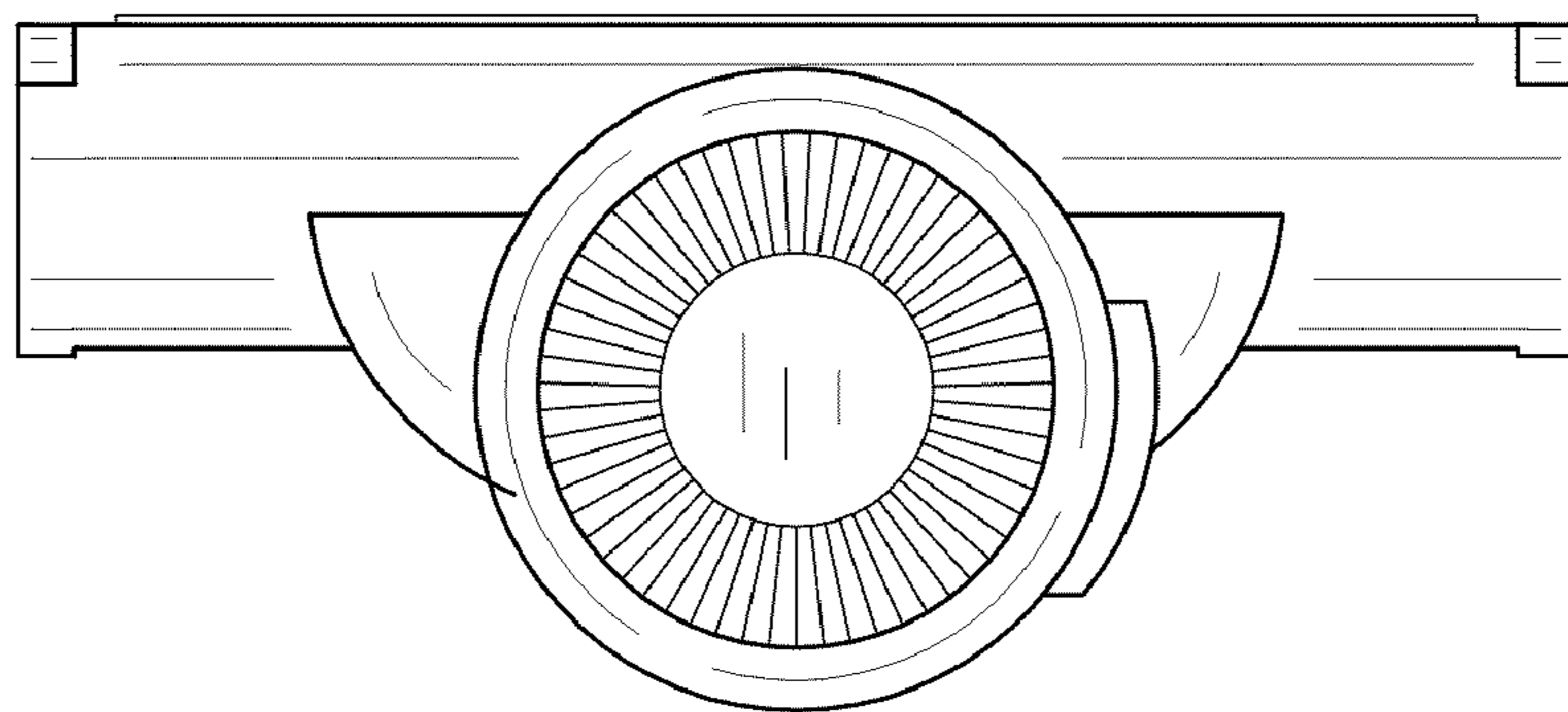

FIG. 5



FIG. 6

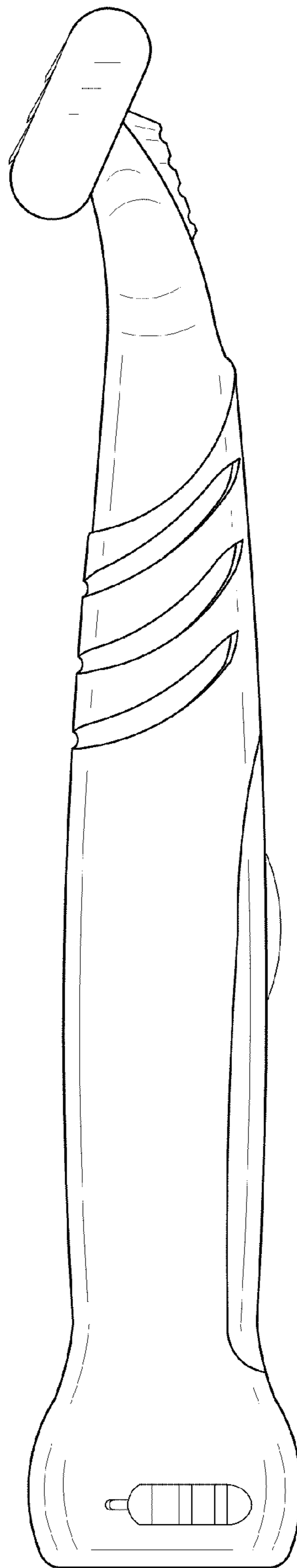

FIG. 7