



US00D652951S

(12) **United States Design Patent**
Crane et al.

(10) **Patent No.:** **US D652,951 S**
(45) **Date of Patent:** **** Jan. 24, 2012**

(54) **STEEL STUD DEFLECTION CONNECTOR**

(76) Inventors: **James Anthony Crane**, York, SC (US);
Fred J. Serpico, Fayetteville, GA (US)

(**) Term: **14 Years**

(21) Appl. No.: **29/361,908**

(22) Filed: **May 17, 2010**

(51) **LOC (9) Cl.** **25-02**

(52) **U.S. Cl.** **D25/61**

(58) **Field of Classification Search** D25/126,
D25/61; 52/93.1, 92.1, 92.2, 127.6, 459,
52/481.1, 460, 461, 846, 848, 480, 319, 464,
52/468, 416, 417, 424, 407.3, 392, 396.1
See application file for complete search history.

(56) **References Cited**

U.S. PATENT DOCUMENTS

5,906,080	A	5/1999	diGirolamo et al.	
D421,133	S *	2/2000	Mandell	D25/61
6,295,781	B1 *	10/2001	Thompson	52/712
D463,575	S *	9/2002	Daudet et al.	D25/61
6,688,069	B2	2/2004	Zadeh	
2004/0050013	A1 *	3/2004	Okada et al.	52/726.2
2006/0080934	A1 *	4/2006	Petrova	52/726.2

* cited by examiner

Primary Examiner — Doris Clark

(74) *Attorney, Agent, or Firm* — QuickPatents, Inc.; Kevin Prince

(57) **CLAIM**

What is claimed is the ornamental design for a steel stud deflection connector, as shown and described.

DESCRIPTION

FIG. 1 is a perspective view of a first embodiment of a steel stud deflection connector, showing the new design;
 FIG. 2 is a front elevational view thereof;
 FIG. 3 is a top plan view thereof;
 FIG. 4 is a rear elevational view thereof;
 FIG. 5 is a bottom plan view thereof;
 FIG. 6 is a right-side elevational view thereof, the left-side elevational view being a mirror image thereof;
 FIG. 7 is a reduced perspective view, illustrating the first embodiment of the design positioned as though in use;
 FIG. 8 is a perspective view of a second embodiment of the design;
 FIG. 9 is a front elevational view thereof;
 FIG. 10 is a top plan view thereof;
 FIG. 11 is a bottom plan view thereof;
 FIG. 12 is a rear elevational view thereof;
 FIG. 13 is a right-side elevational view thereof, the left-side elevational view being a mirror image thereof; and,
 FIG. 14 is a reduced perspective view, illustrating the second embodiment of the design positioned as though in use.
 The broken lines showing building frame elements in FIGS. 7 and 14 are included for the purpose of illustrating the invention in use, and form no part of the claimed design.

1 Claim, 8 Drawing Sheets

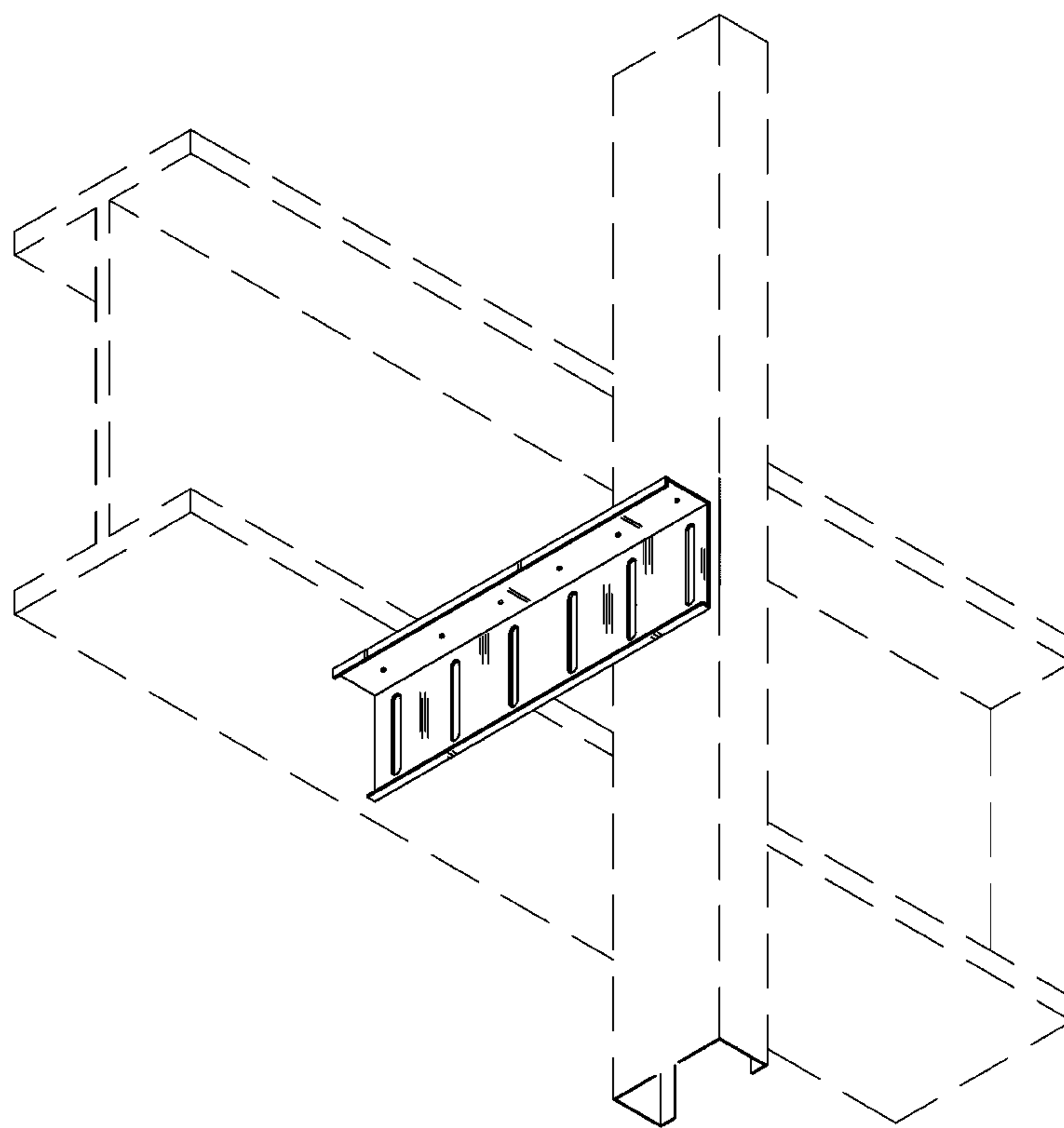

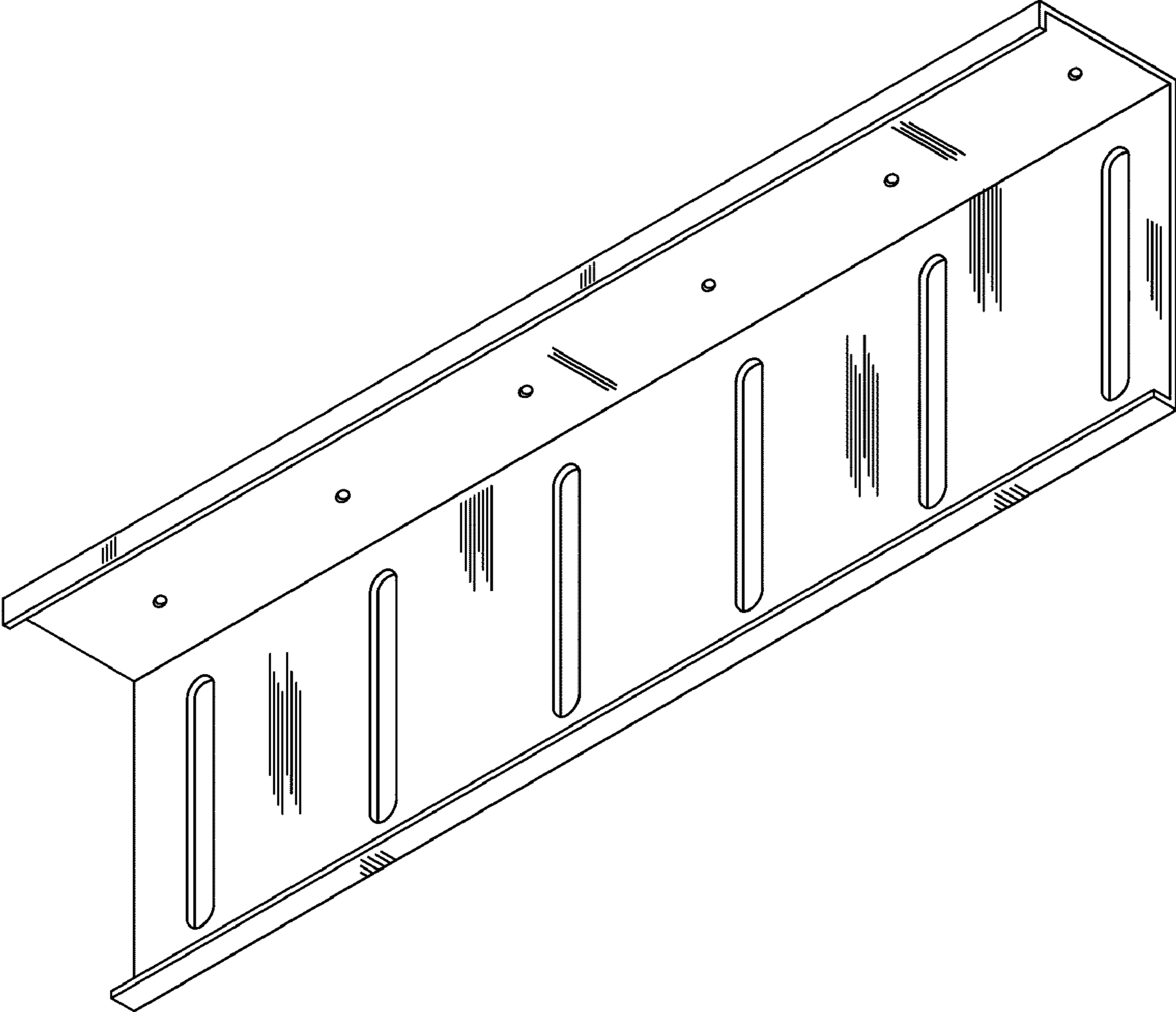

Fig. 1

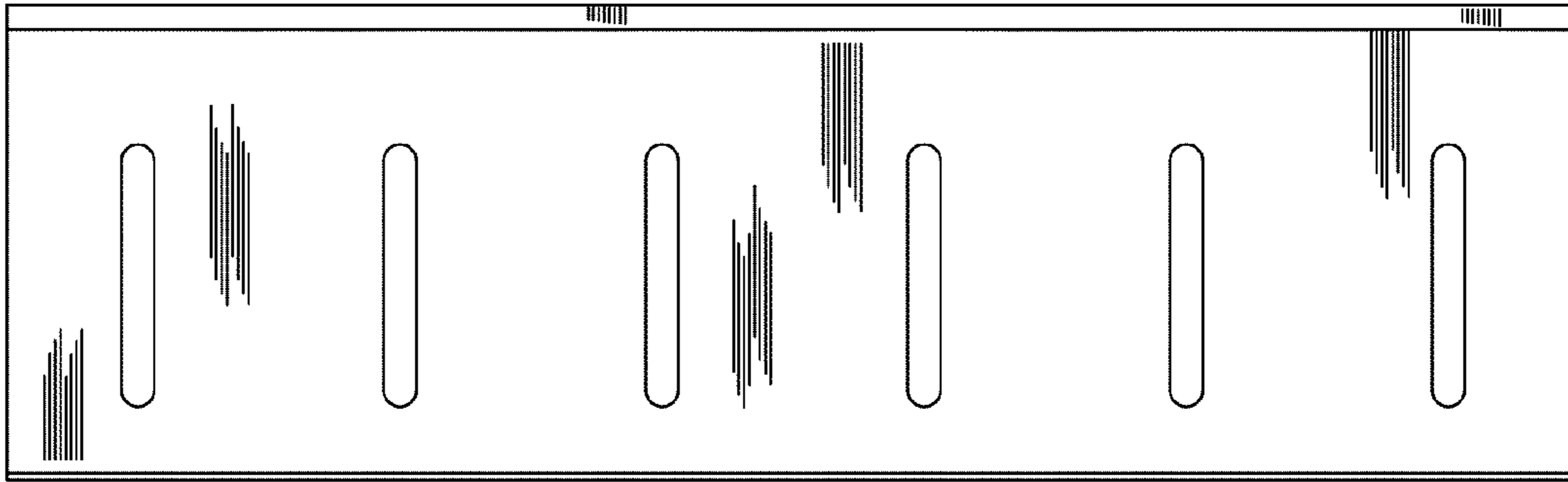

Fig. 2

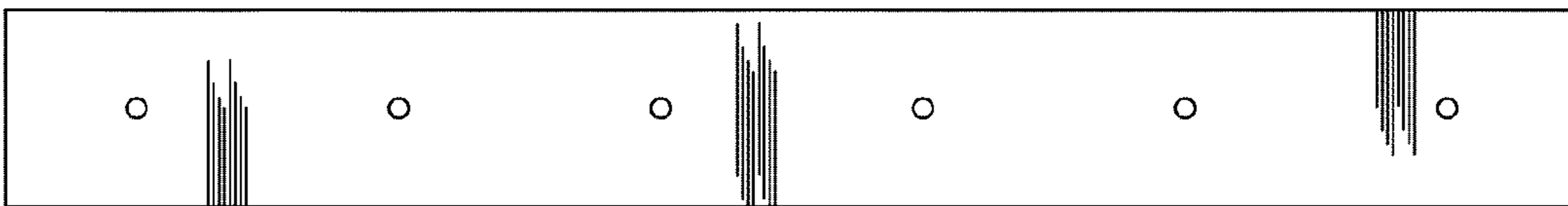

Fig. 3

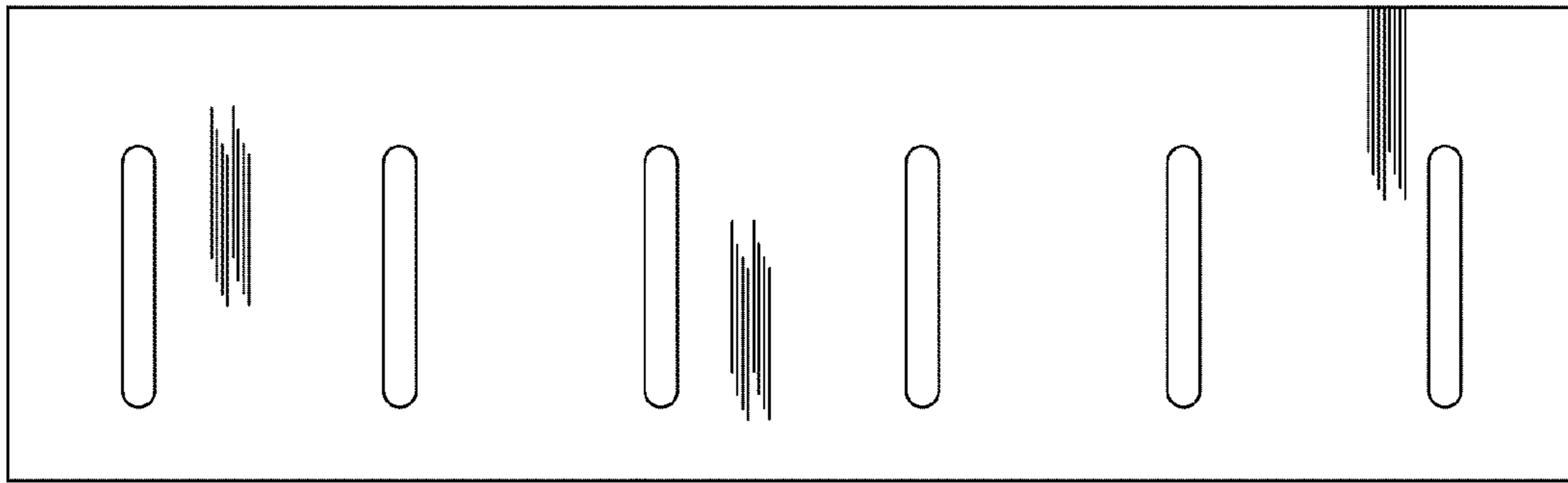

Fig. 4

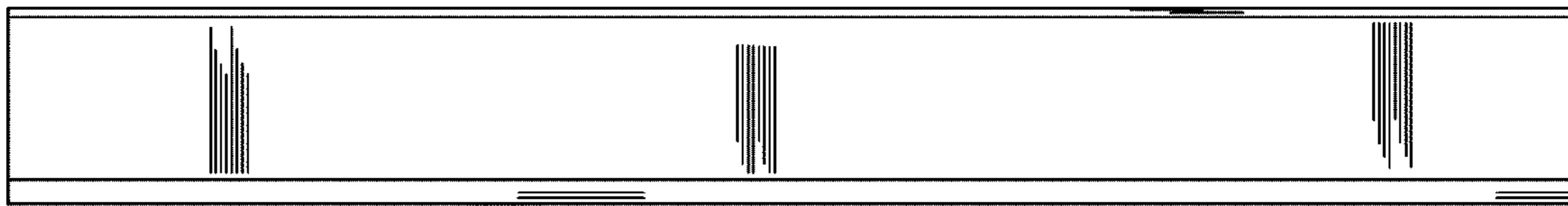

Fig. 5

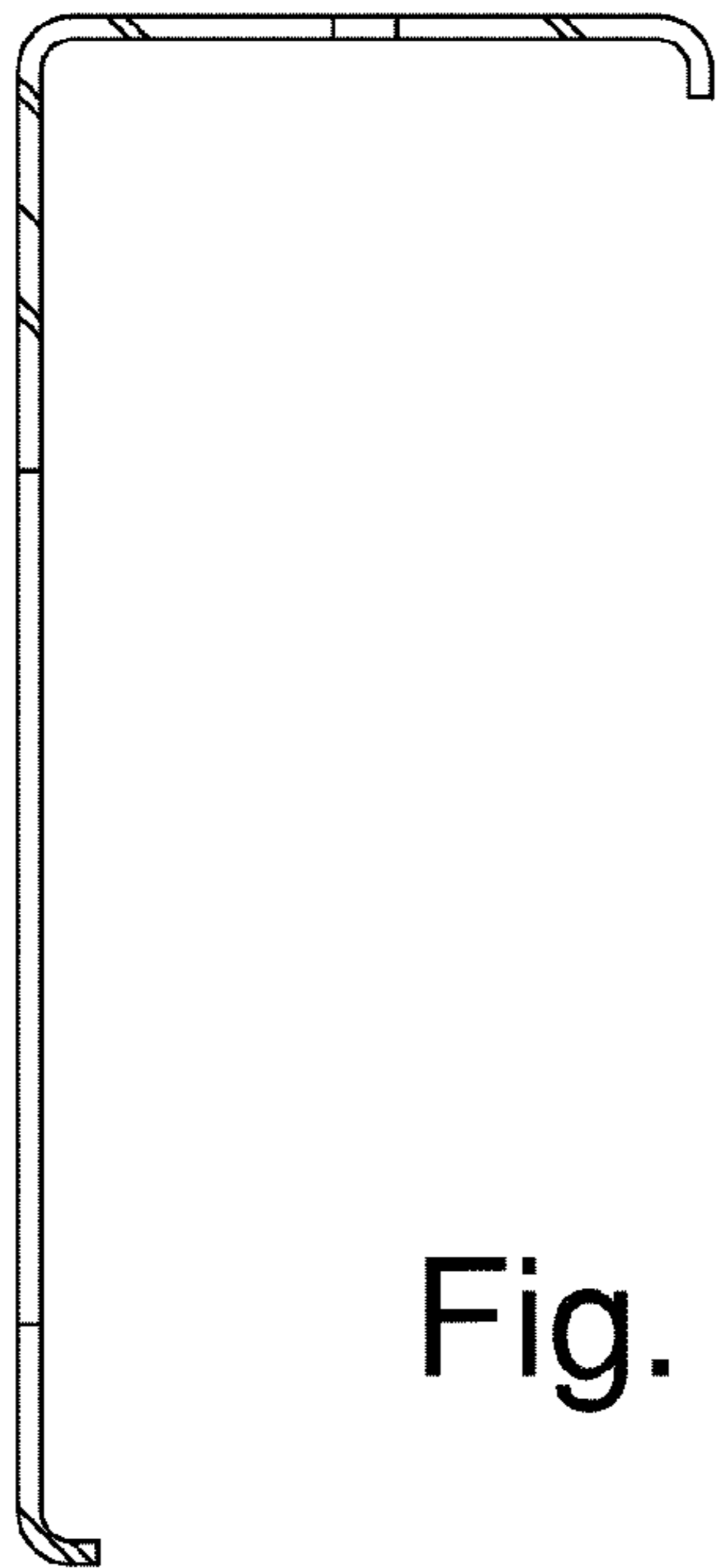

Fig. 6

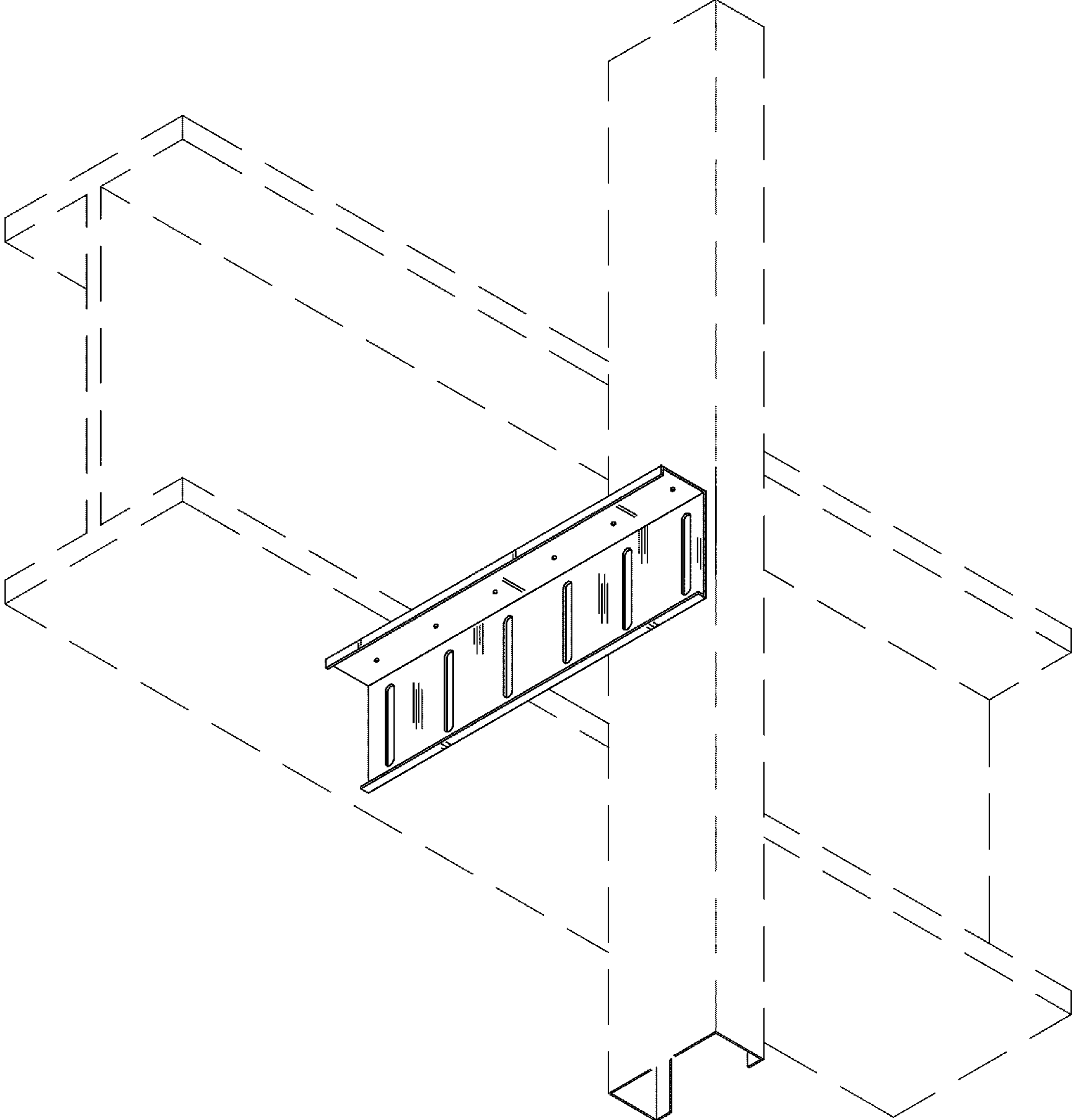

Fig. 7

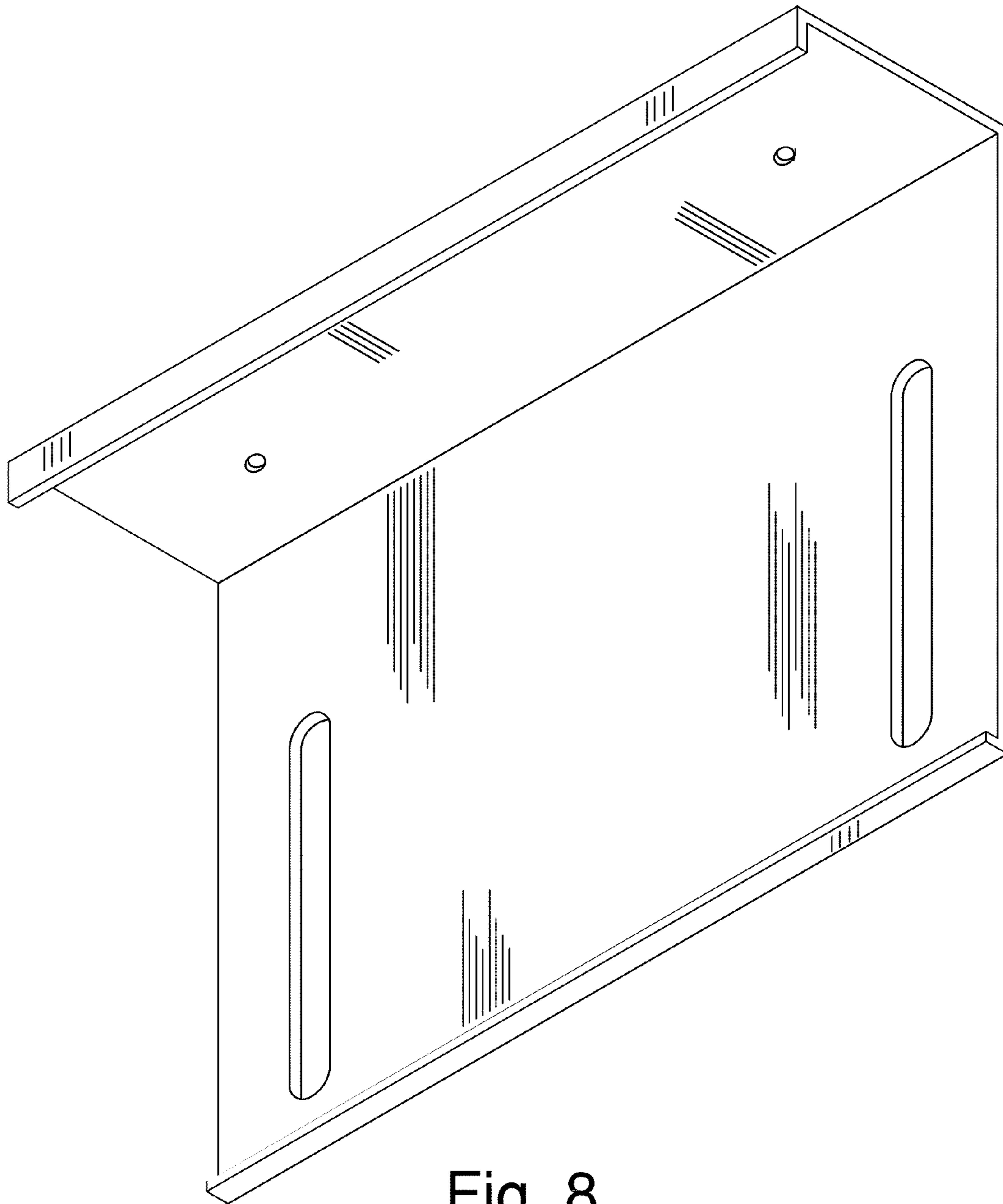

Fig. 8

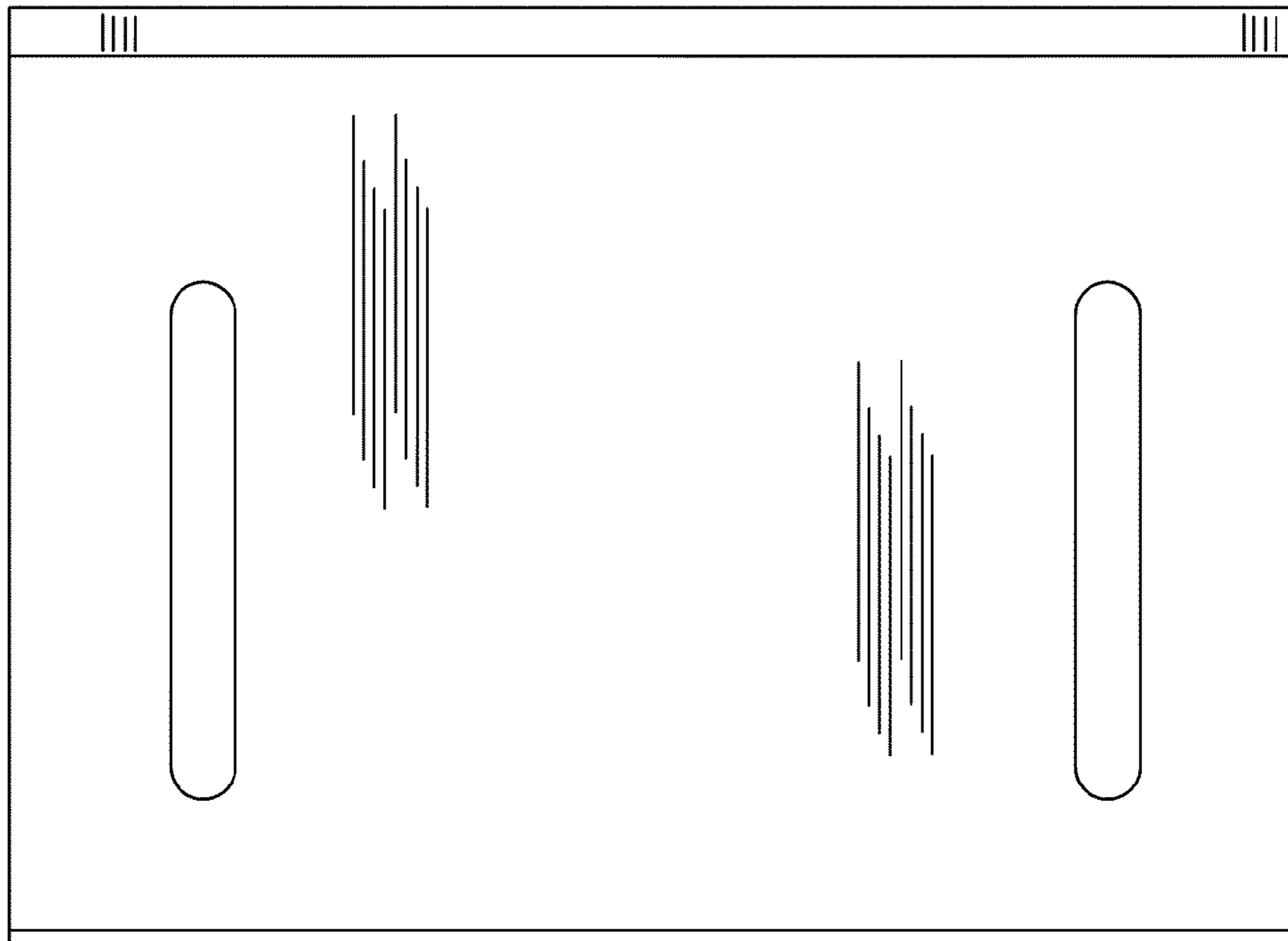

Fig. 9

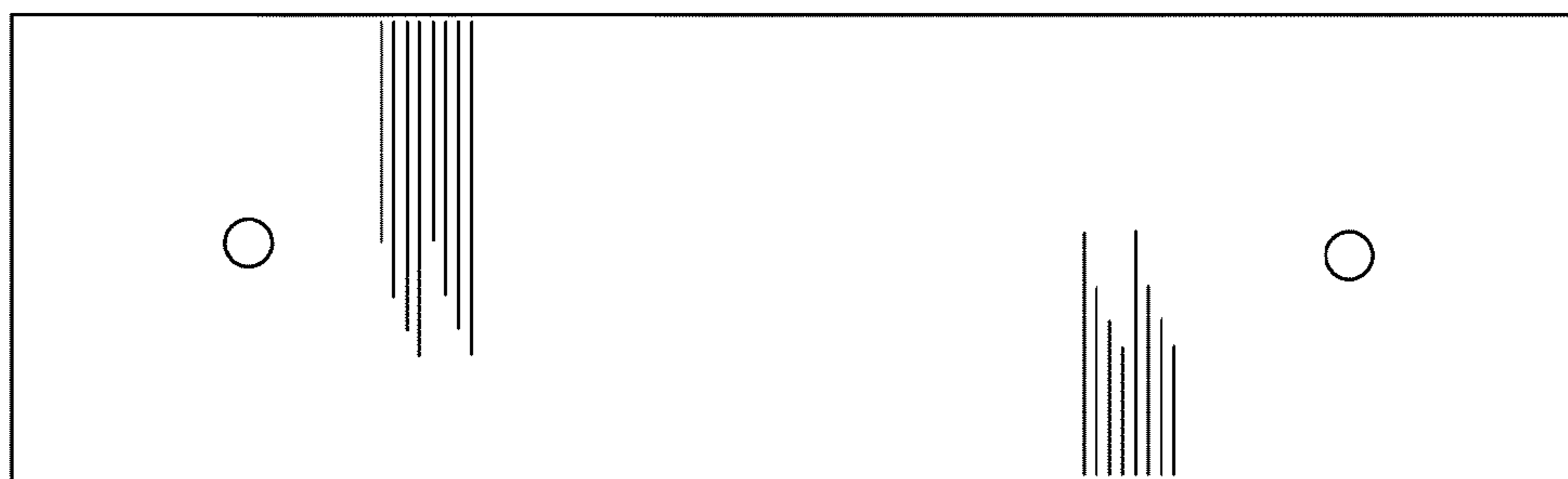

Fig. 10

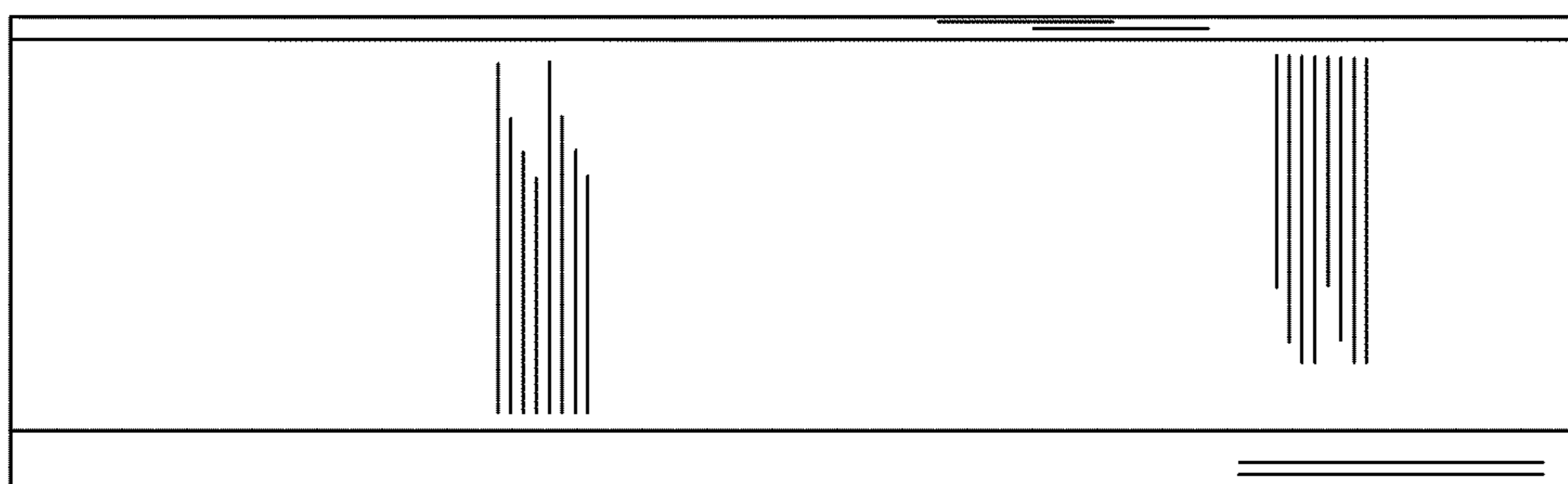

Fig. 11

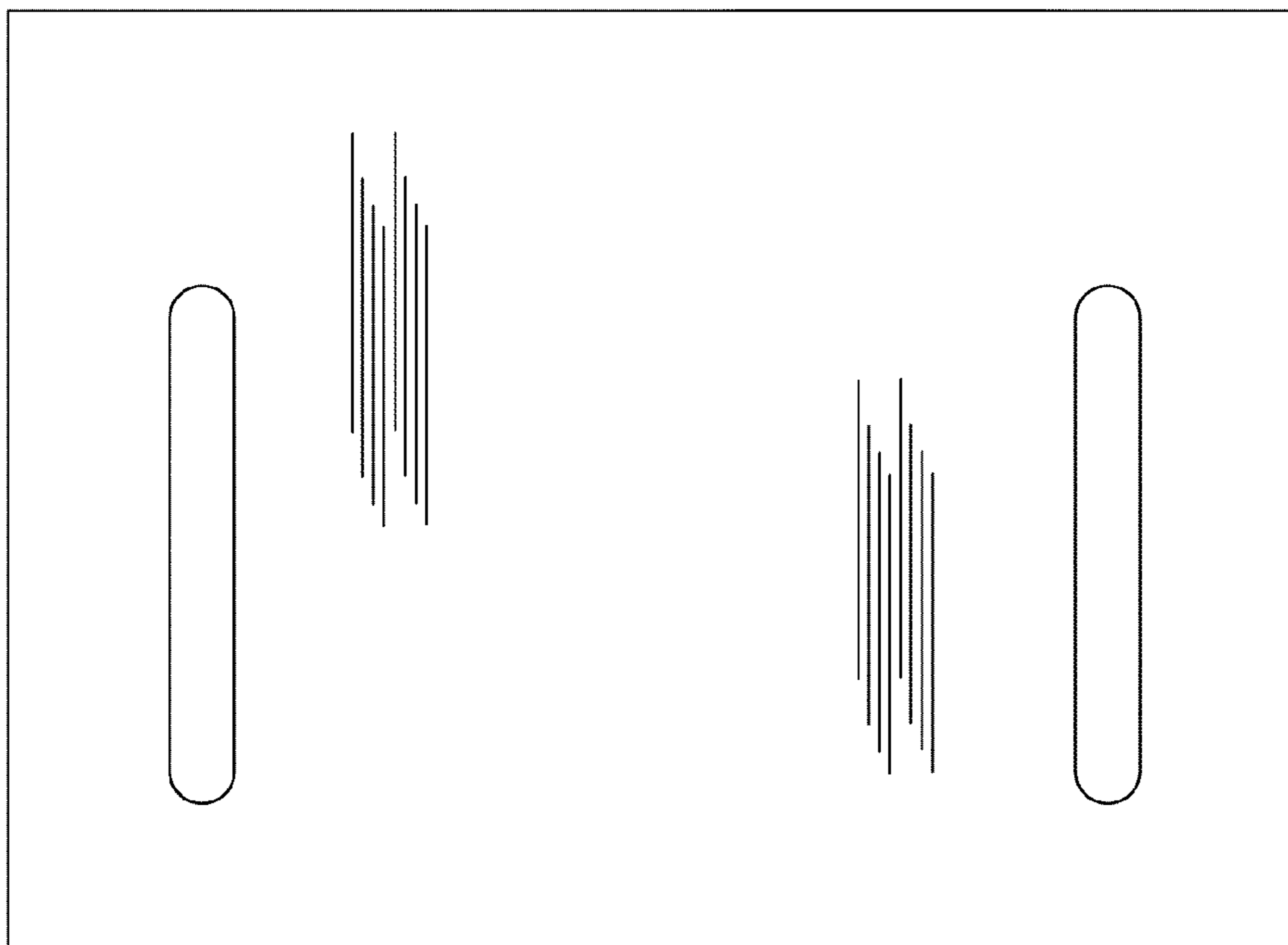

Fig. 12

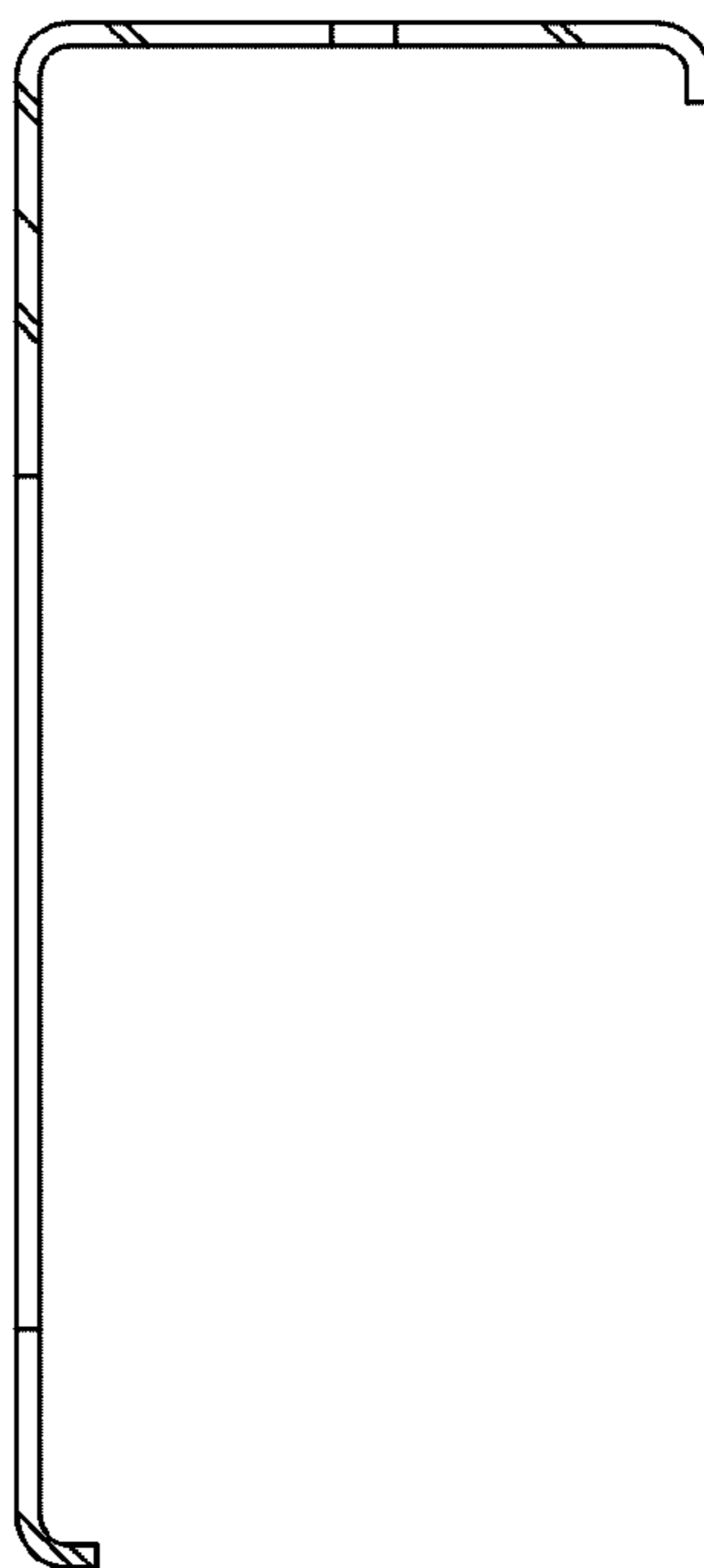

Fig. 13

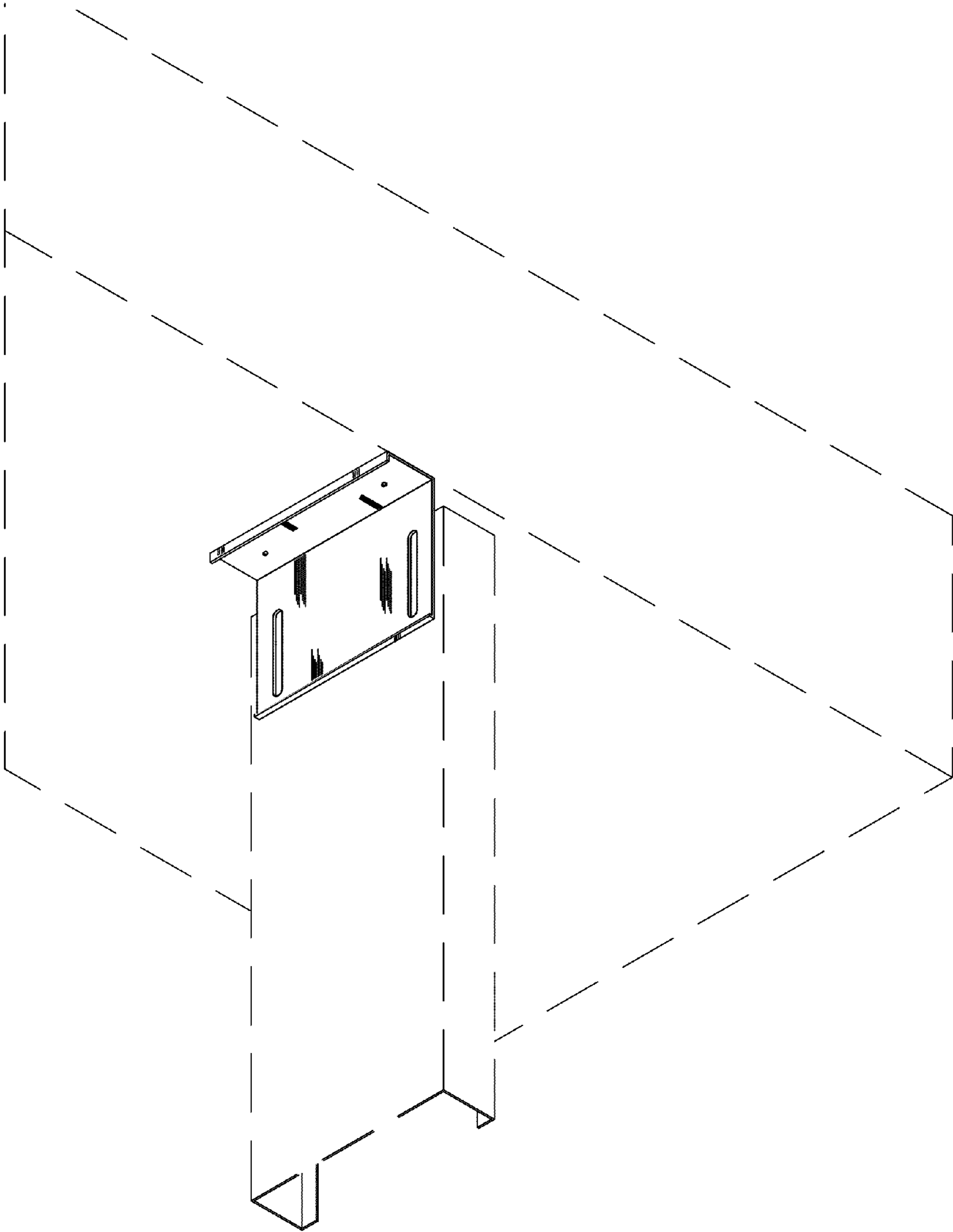

Fig. 14