



US00D652946S

(12) **United States Design Patent**
Chen

(10) **Patent No.:** **US D652,946 S**
(45) **Date of Patent:** **** Jan. 24, 2012**

(54) **VIBRATOR**

(75) Inventor: **Xueliang Chen**, Liaoyang (CN)

(73) Assignee: **Liaoyang Baile Health Care Product Co., Ltd.**, Liaoyang, Liaoning Province (CN)

(**) Term: **14 Years**

(21) Appl. No.: **29/393,786**

(22) Filed: **Jun. 9, 2011**

(51) **LOC (9) Cl.** **28-03**

(52) **U.S. Cl.** **D24/215**

(58) **Field of Classification Search** D24/200,
D24/211-215; 601/39, 40, 48, 52, 63, 68,
601/72, 80, 112, 113, 120, 121, 125, 134,
601/137, DIG. 5, DIG. 14, DIG. 16, DIG. 17
See application file for complete search history.

D495,423 S	8/2004	Nan	
D495,424 S	8/2004	Nan	
D495,804 S	9/2004	Nan	
D499,811 S	12/2004	Nan	
D509,301 S	9/2005	Talbot et al.	
D523,562 S	6/2006	Telford	
D539,432 S	3/2007	Nan	
D539,433 S *	3/2007	Lui D24/215
D565,191 S *	3/2008	Nan D24/215
D603,523 S *	11/2009	Nan et al. D24/215
D620,601 S	7/2010	TerMeer	
D630,761 S	1/2011	Marshall	
D631,973 S	2/2011	Imboden et al.	
D631,974 S	2/2011	Imboden et al.	
2009/0312599 A1 *	12/2009	Smith 600/38

* cited by examiner

Primary Examiner — Sandra Snapp
(74) *Attorney, Agent, or Firm* — Pujie Zheng

(57) **CLAIM**
We claim the ornamental design for a vibrator, as shown and described.

(56) **References Cited**

DESCRIPTION

U.S. PATENT DOCUMENTS

D248,773 S *	8/1978	Schaefer D24/215
D273,132 S	3/1984	Moloff	
D358,894 S *	5/1995	Ivy et al. D24/211
D359,359 S *	6/1995	Robertson et al. D24/211
D359,360 S *	6/1995	Ivy et al. D24/211
D361,133 S *	8/1995	Robertson et al. D24/211
D376,650 S	12/1996	Kain	
D426,311 S	6/2000	Horowitz et al.	
D454,959 S	3/2002	Harris et al.	
D476,087 S	6/2003	Dirks et al.	

FIG. 1 is a perspective view of the front of the vibrator.
FIG. 2 is a perspective view of the back thereof.
FIG. 3 is a bottom view of the vibrator.
FIG. 4 is a right side view thereof.
FIG. 5 is a front view thereof.
FIG. 6 is a left side view thereof.
FIG. 7 is a back view thereof; and,
FIG. 8 is a top view thereof.

1 Claim, 8 Drawing Sheets

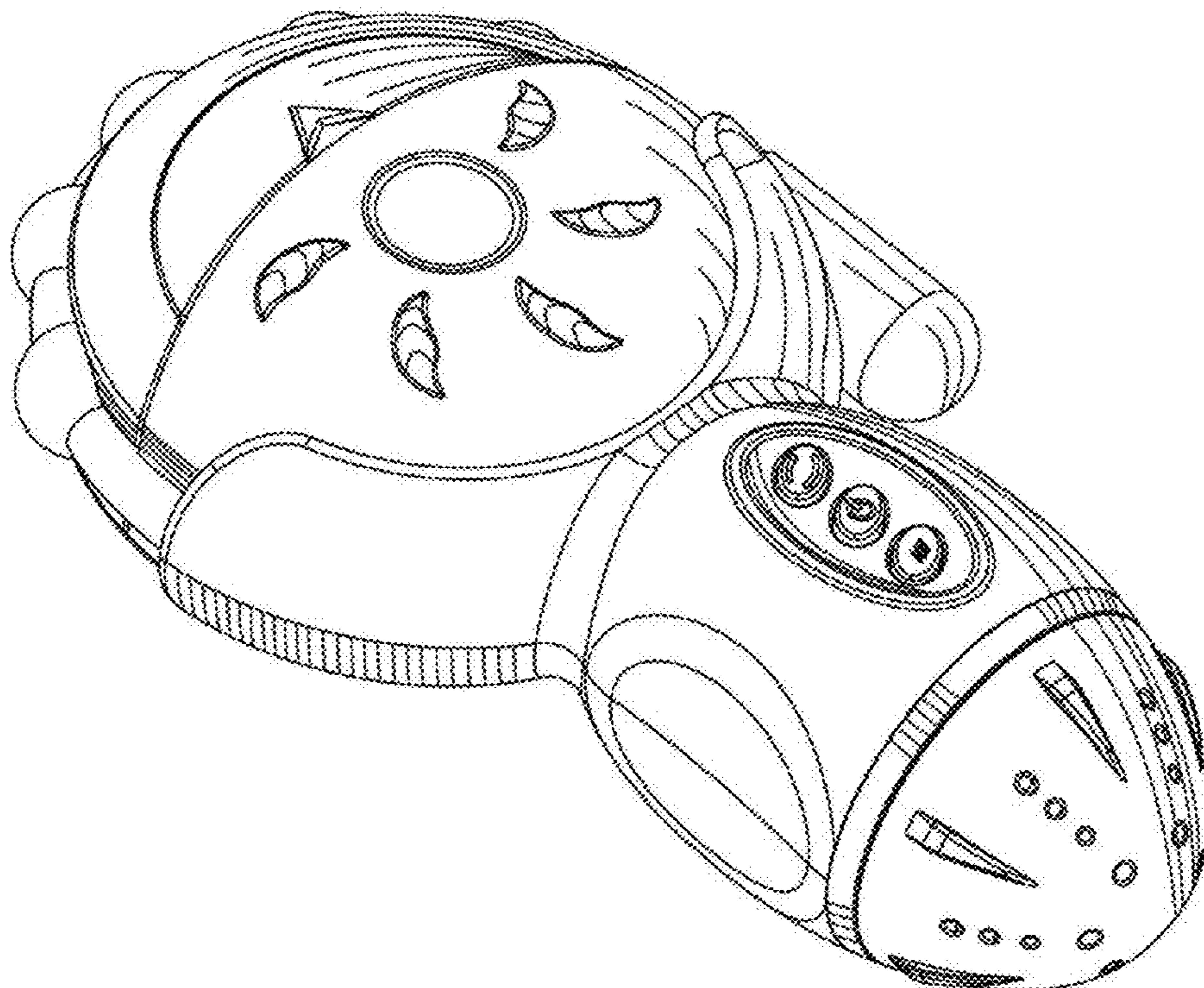

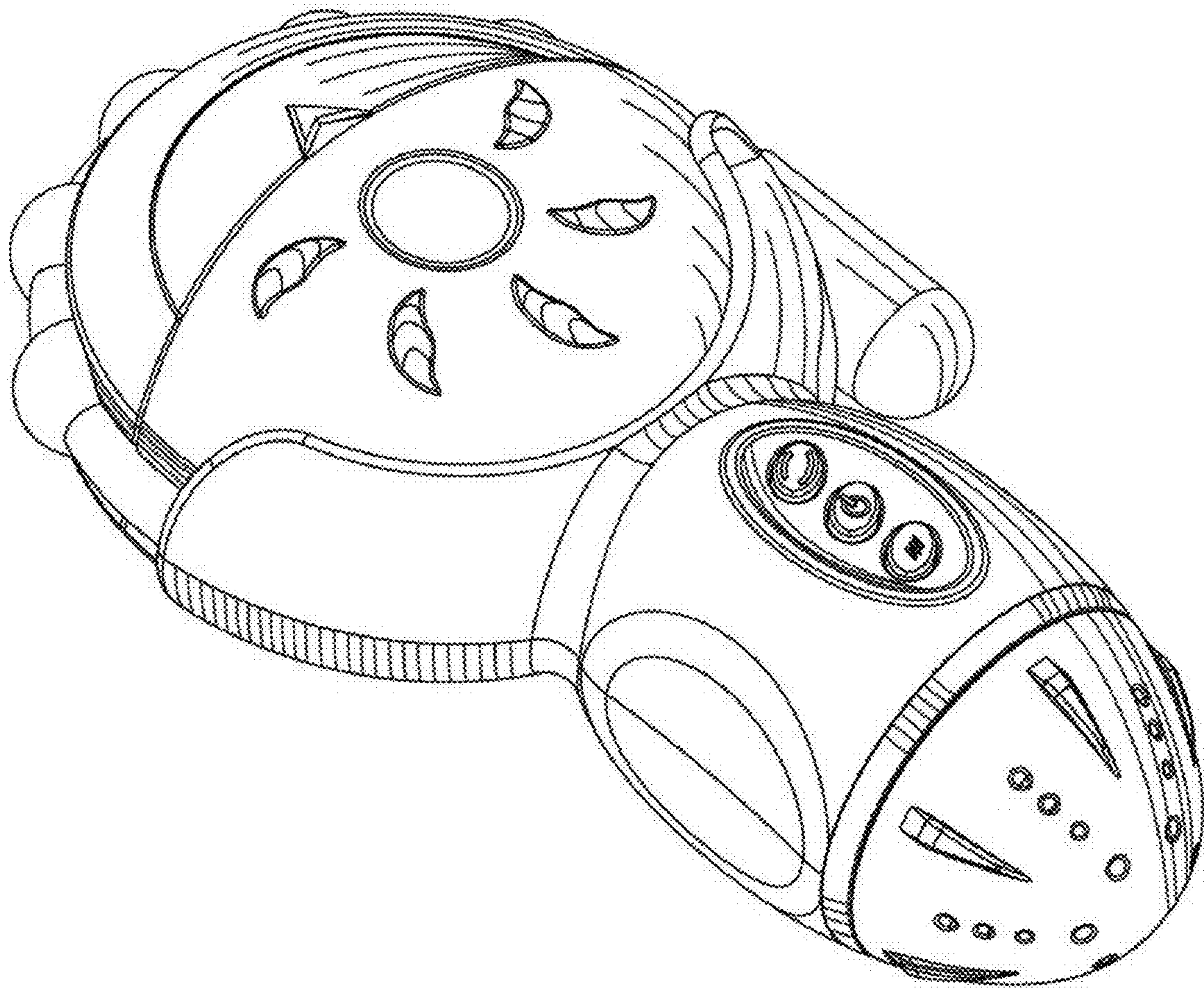

FIG. 1

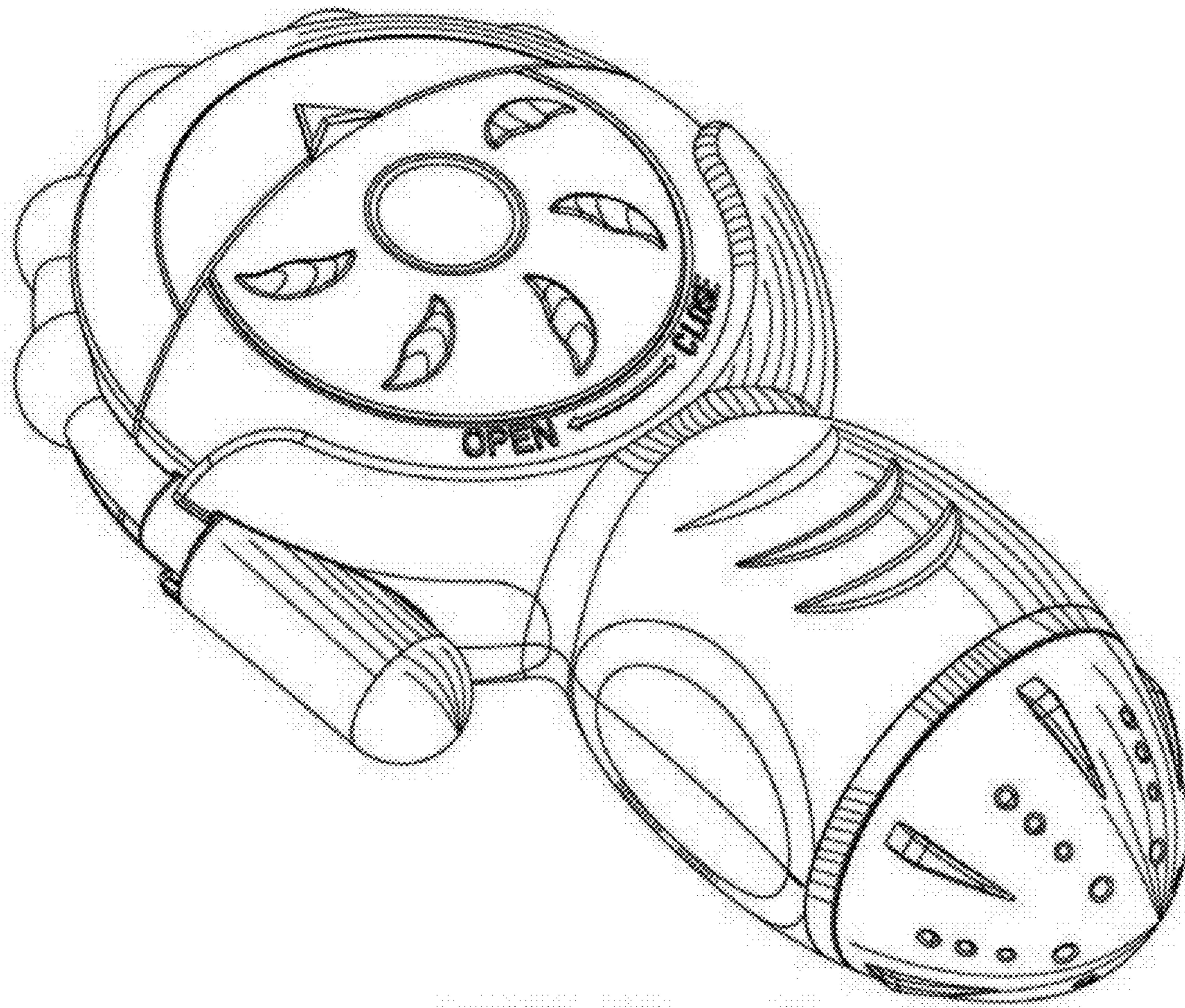

FIG. 2

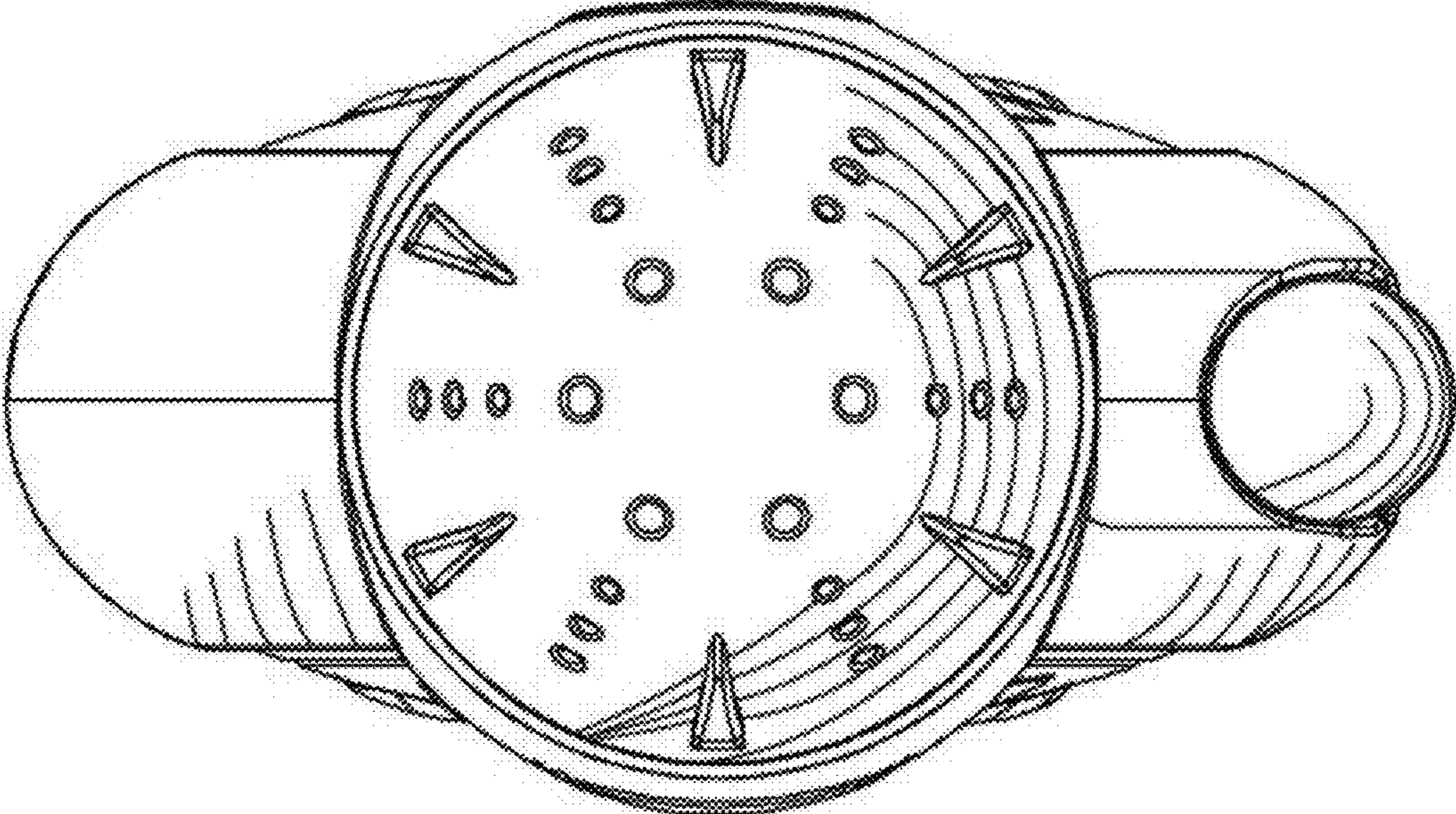

FIG. 3

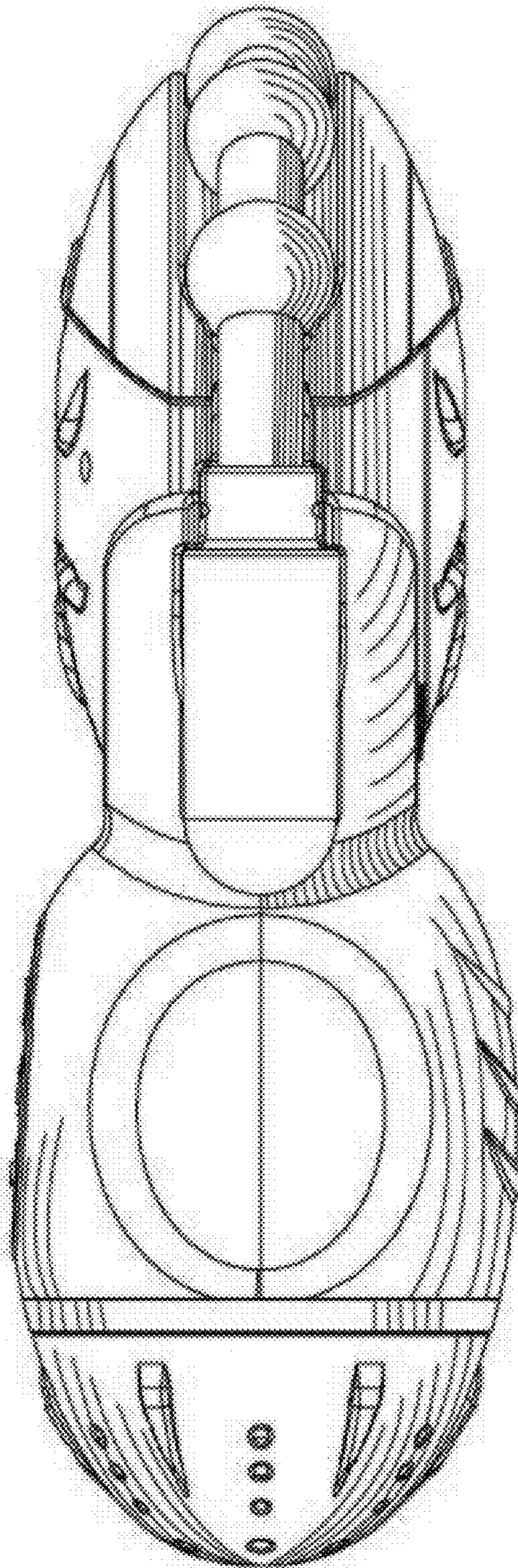

FIG. 4

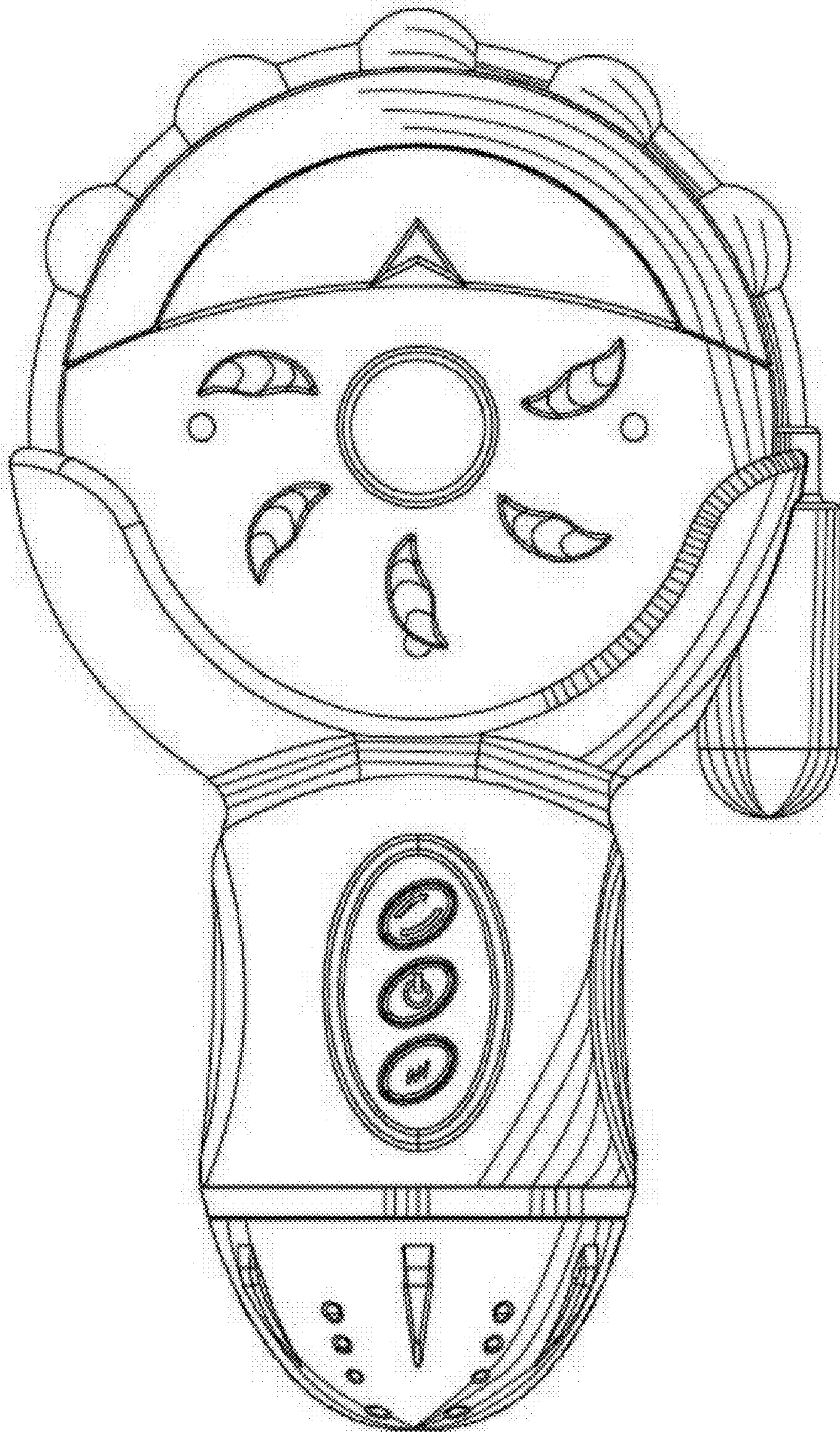

FIG. 5

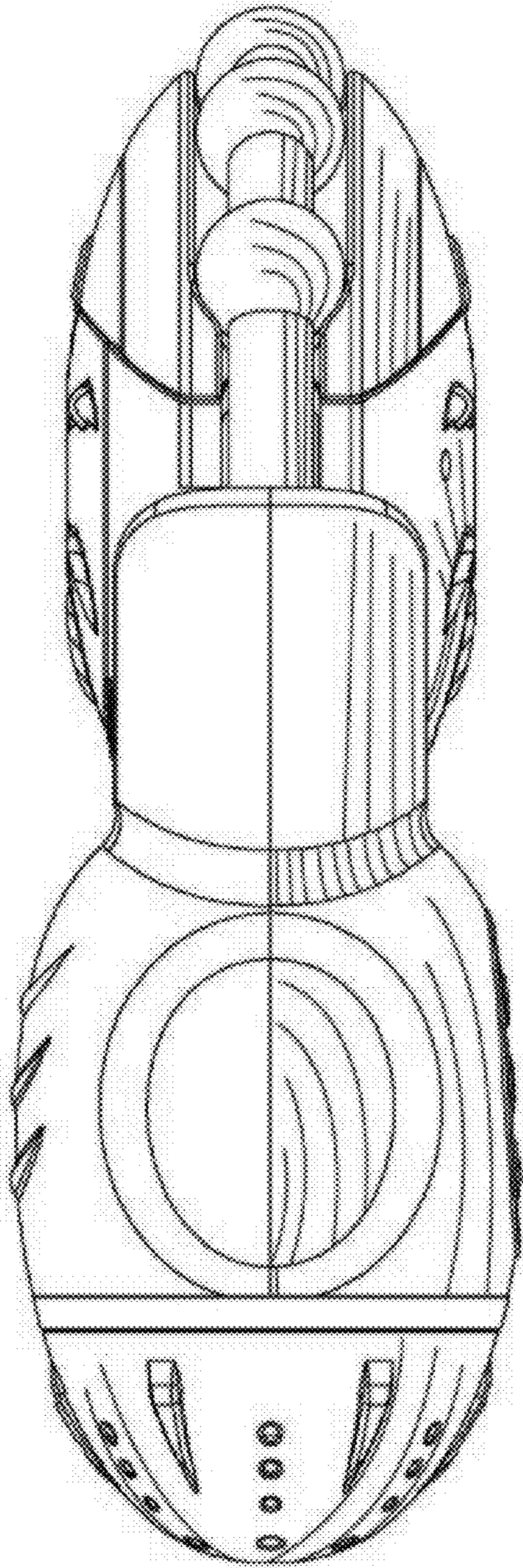

FIG. 6

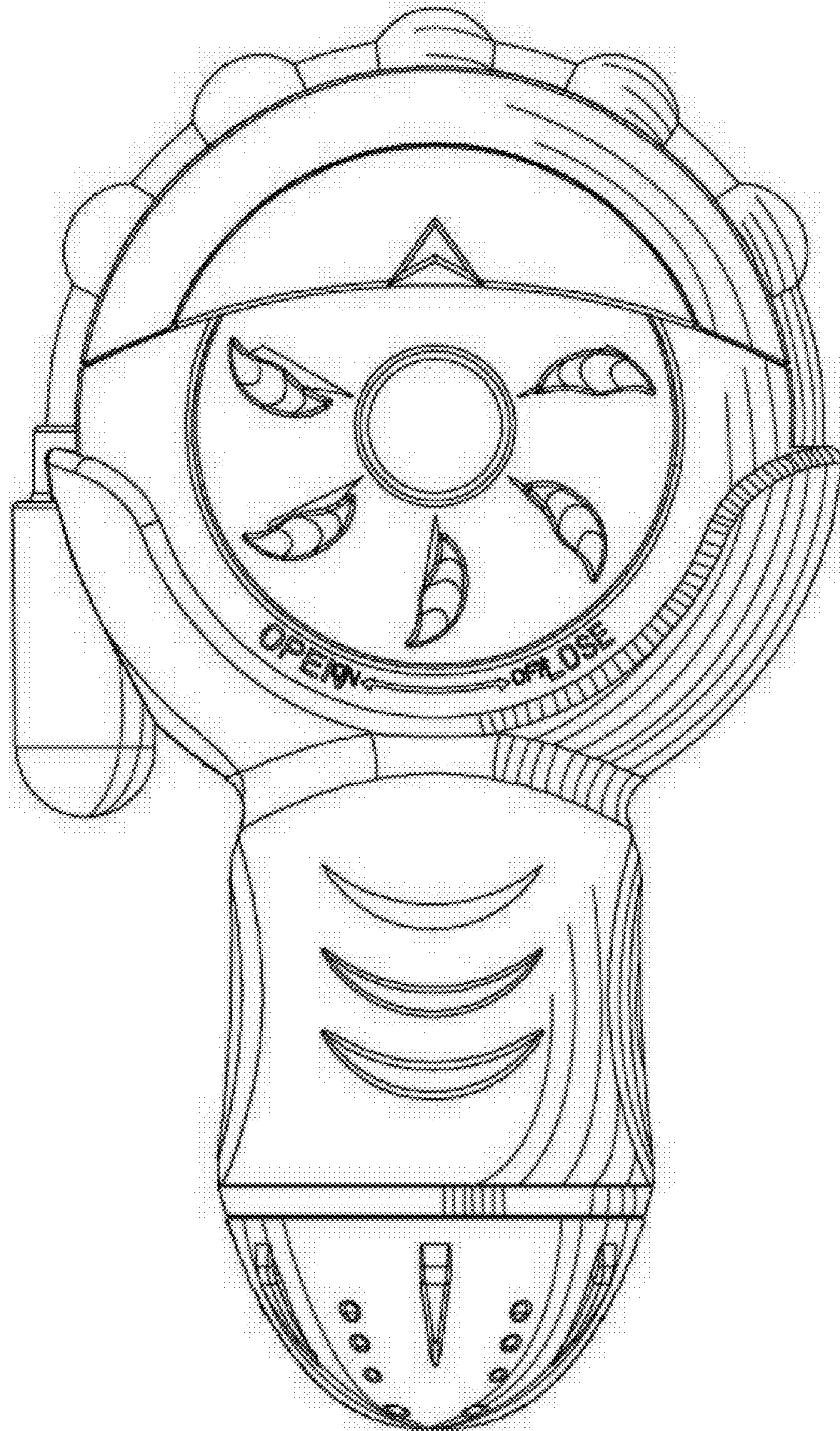

FIG. 7

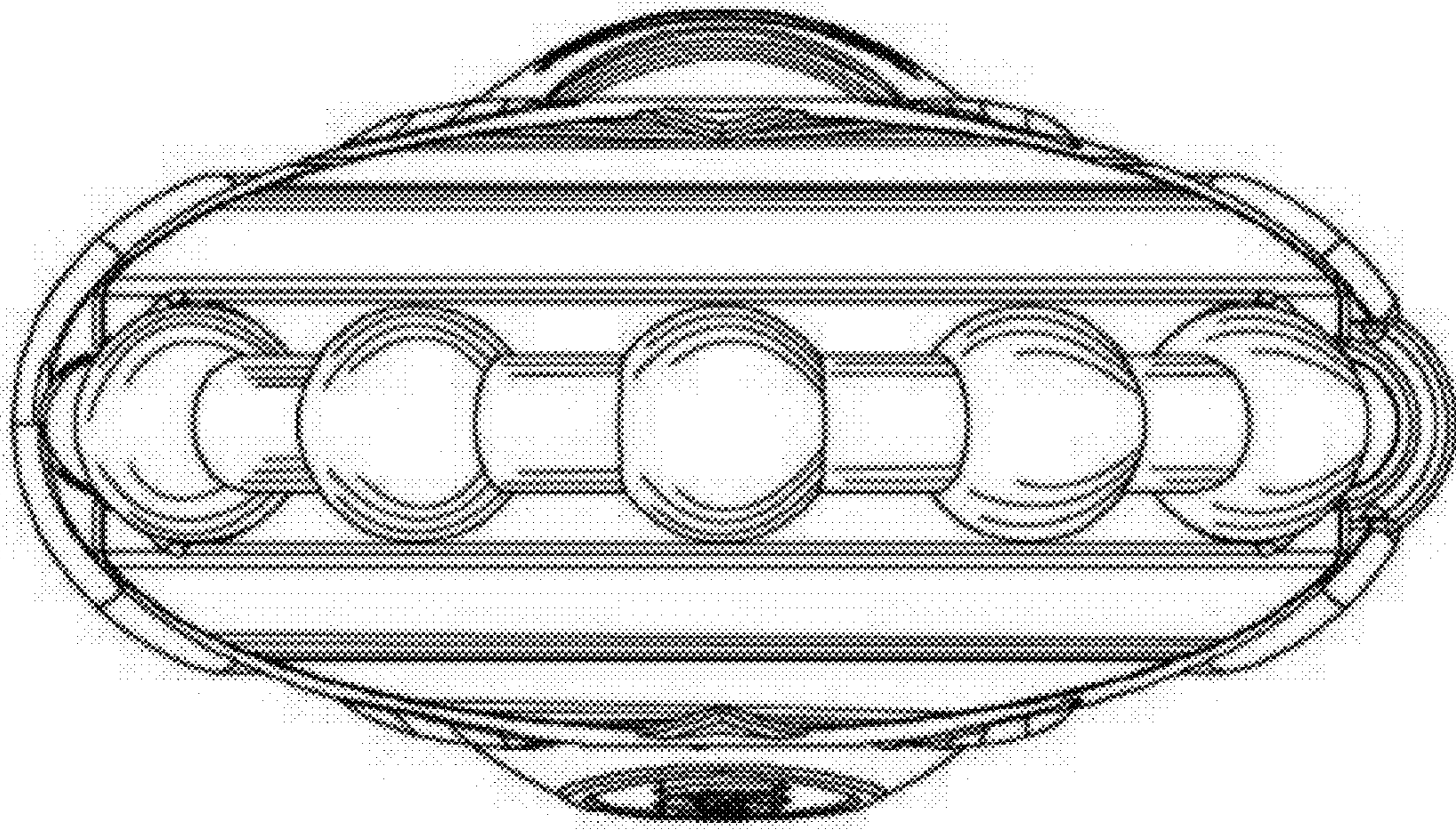

FIG. 8