



US00D652915S

(12) **United States Design Patent**
Wills et al.

(10) **Patent No.:** **US D652,915 S**
(45) **Date of Patent:** **** Jan. 24, 2012**

(54) **LIQUID MEDICATION DISPENSER**

(75) Inventors: **Thomas A. Wills**, Deland, FL (US);
John Addison, Eads, TN (US)

(73) Assignee: **Gliders, LLC**, Lakewood, CO (US)

(**) Term: **14 Years**

(21) Appl. No.: **29/379,828**

(22) Filed: **Nov. 24, 2010**

(51) **LOC (9) Cl.** **24-02**

(52) **U.S. Cl.** **D24/115**

(58) **Field of Classification Search** D24/112-119,
D24/121, 133, 130; 606/181, 185; D19/41,
D19/43, 51; 222/153.1, 153.11, 325, 402.11,
222/175, 205; D9/695, 697, 699, 723-728,
D9/686, 688-691; 424/400; 141/114, 115

See application file for complete search history.

(56) **References Cited**

U.S. PATENT DOCUMENTS

3,116,152 A * 12/1963 Smith 222/205
D356,026 S * 3/1995 Iaia et al. D9/697
D389,915 S * 1/1998 Emerson et al. D24/133
D408,450 S * 4/1999 Kamei D19/51

D412,834 S * 8/1999 Benedict et al. D9/697
D430,802 S * 9/2000 Adachi et al. D9/695
6,199,726 B1 * 3/2001 Cardwell et al. 222/402.11
D465,412 S * 11/2002 Addis et al. D9/697
D479,986 S * 9/2003 Karim D9/697
D561,046 S * 2/2008 Kerman D9/697
D573,253 S * 7/2008 Gonzales et al. D24/113
D601,036 S * 9/2009 Palmer et al. D9/697
D610,469 S * 2/2010 Murray D9/699

* cited by examiner

Primary Examiner — David Muller

(74) *Attorney, Agent, or Firm* — Sheridan Ross P.C.

(57) **CLAIM**

The ornamental design for a liquid medication dispenser, as shown and described.

DESCRIPTION

FIG. 1 is a perspective view of a liquid medication dispenser showing our new design;

FIG. 2 is front elevation view thereof;

FIG. 3 is a rear elevation view thereof;

FIG. 4 is a right side elevation view thereof;

FIG. 5 is a left side elevation view thereof;

FIG. 6 is a top plan view thereof; and,

FIG. 7 is a bottom plan view thereof.

1 Claim, 5 Drawing Sheets

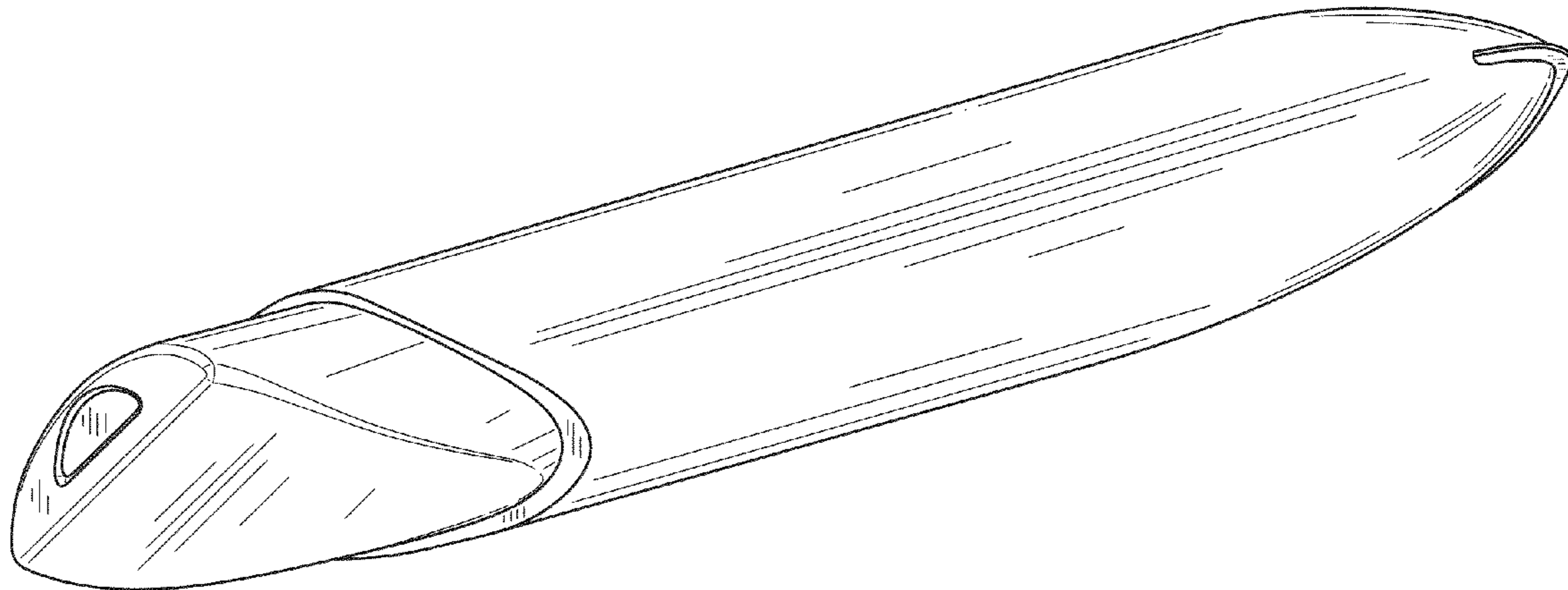

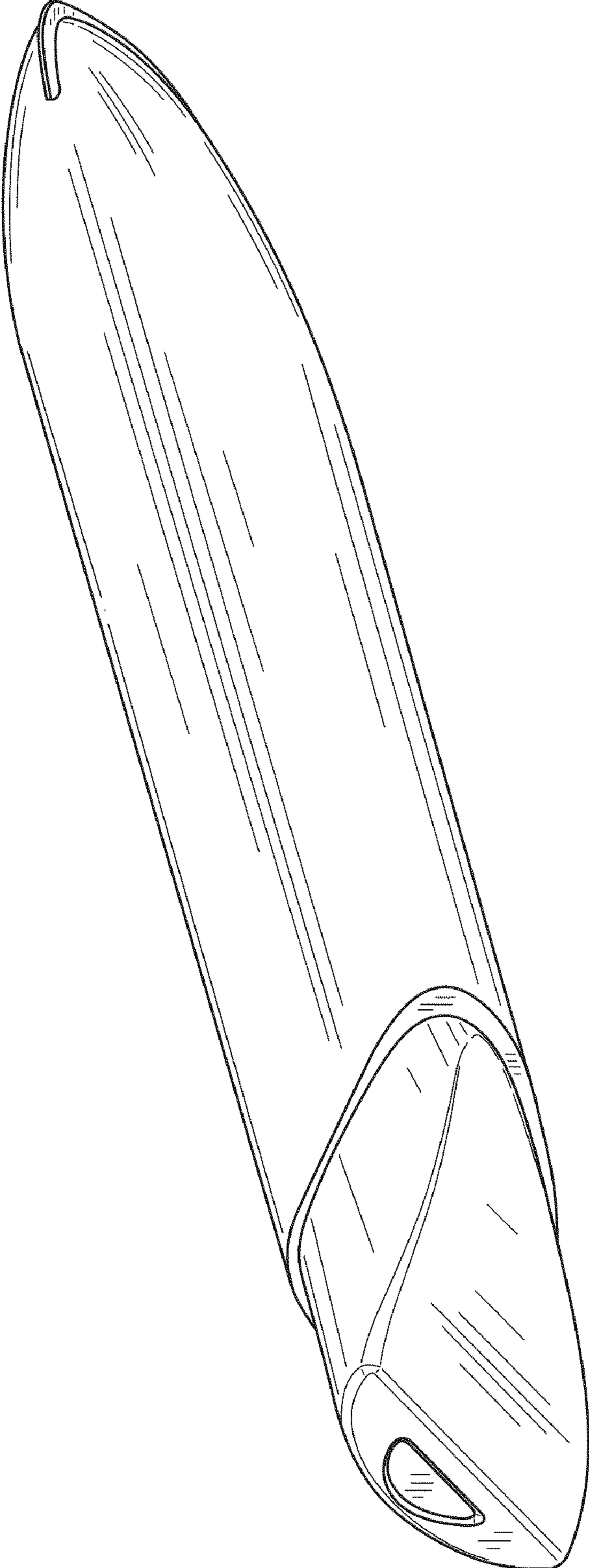

FIG.1

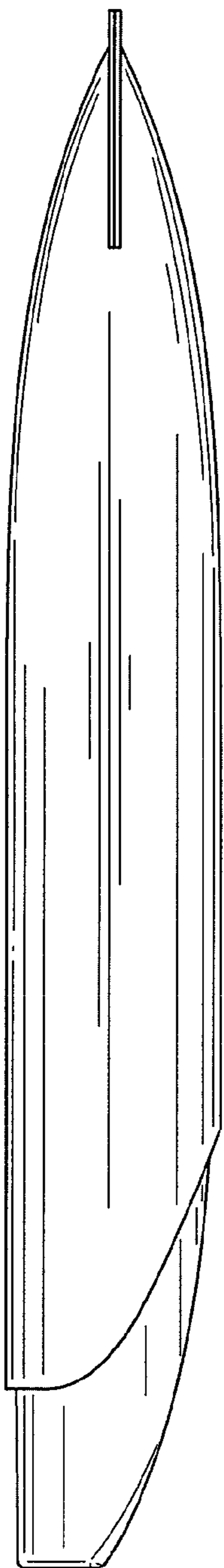

FIG.2

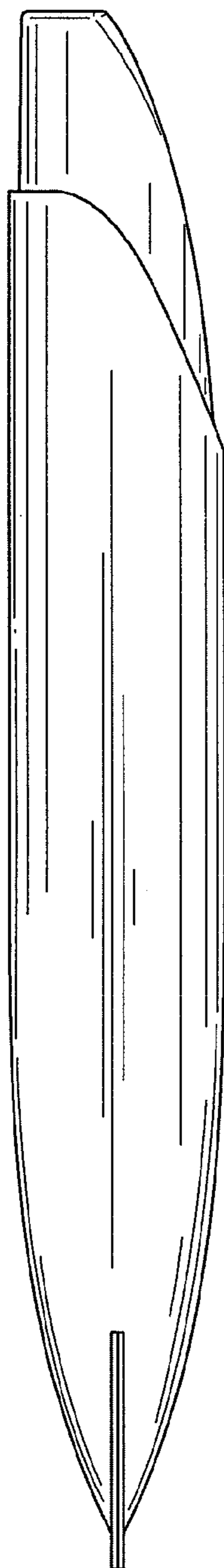

FIG.3

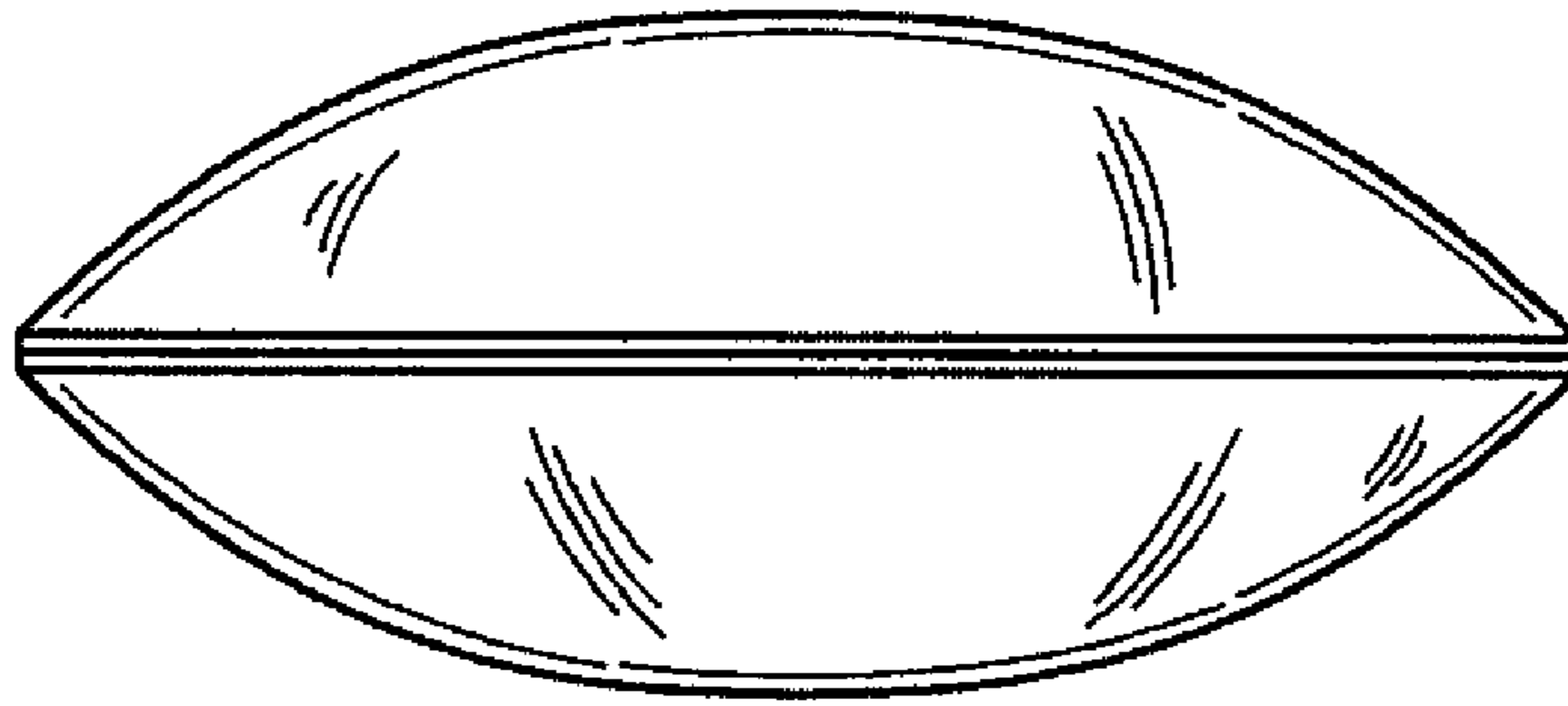

FIG. 4

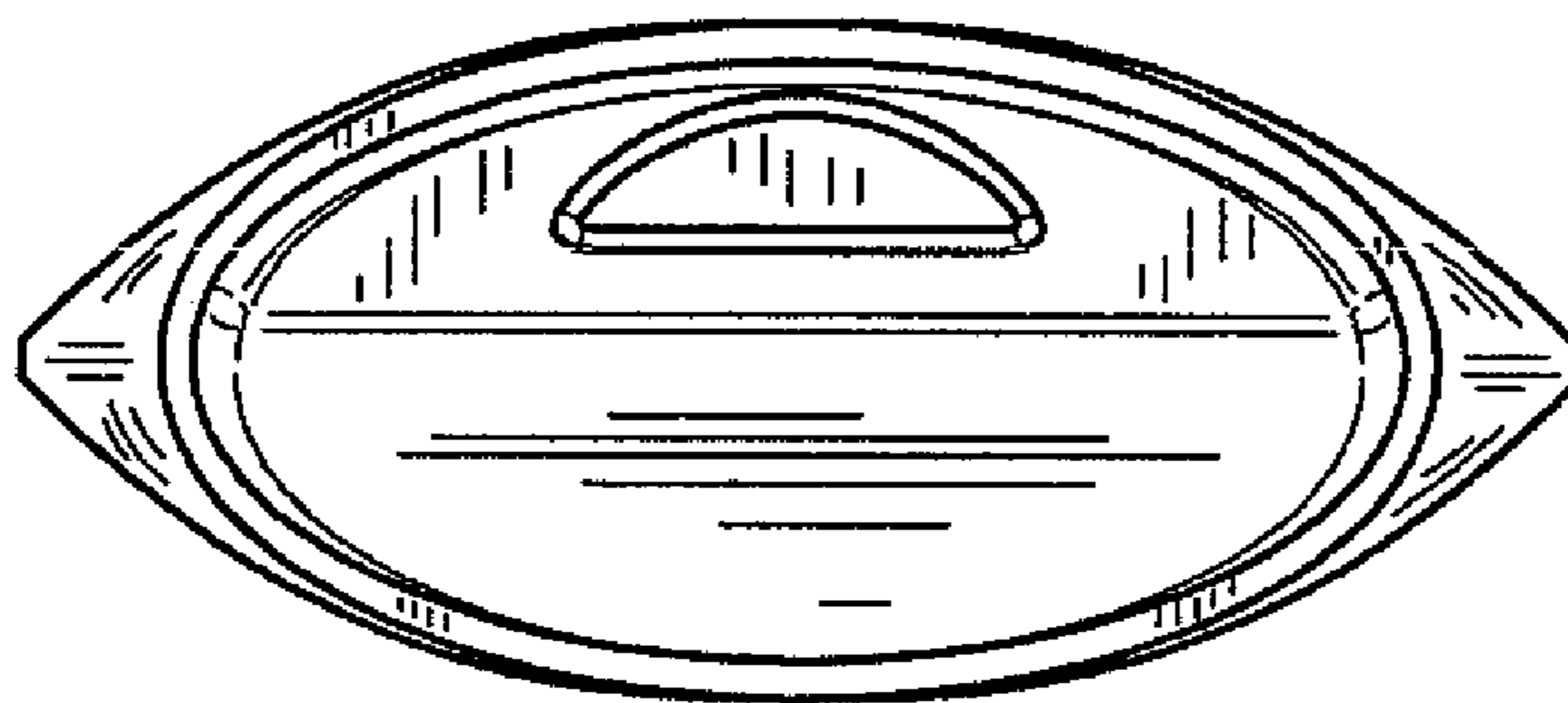

FIG. 5

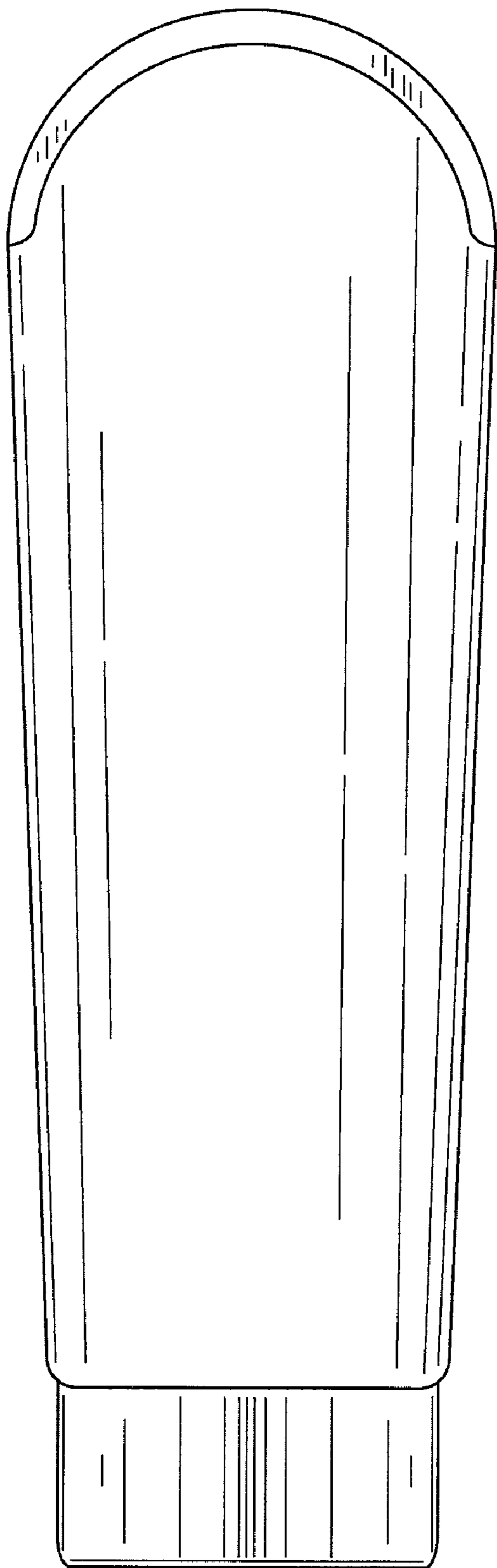

FIG.6

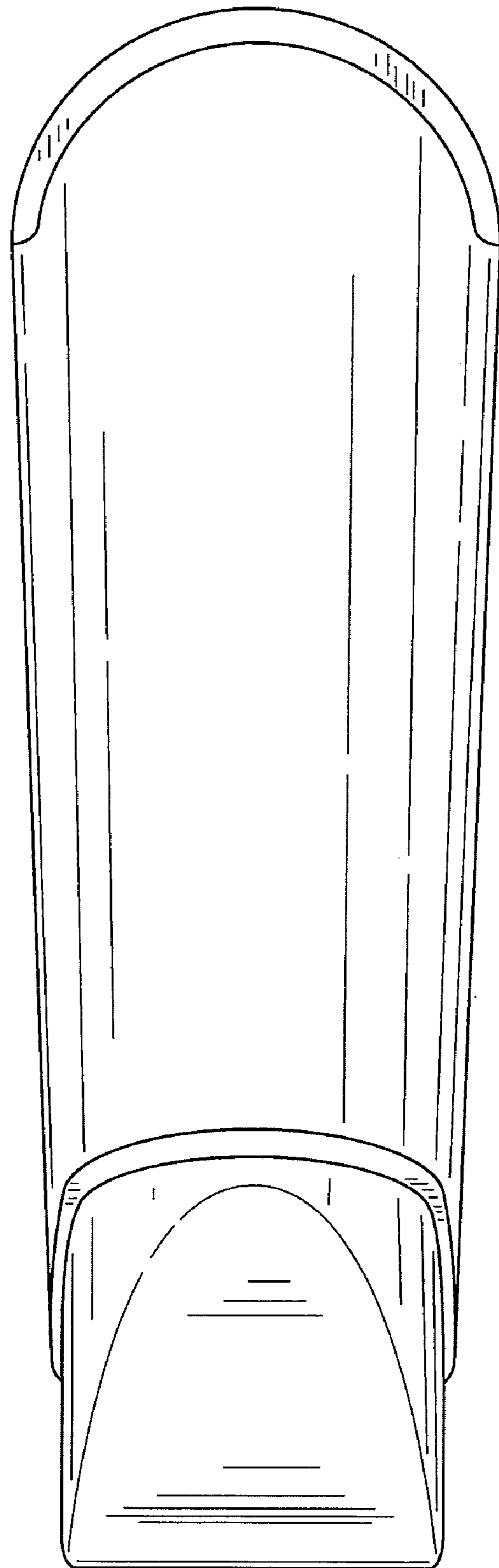

FIG.7