



US00D652824S

(12) **United States Design Patent**  
**Strauser**

(10) **Patent No.:** **US D652,824 S**

(45) **Date of Patent:** **\*\* Jan. 24, 2012**

(54) **ACOUSTIC GUITAR MICROPHONE**

(76) **Inventor:** **Jack Strauser, Pinellas Park, FL (US)**

(\*\*) **Term:** **14 Years**

(21) **Appl. No.:** **29/363,431**

(22) **Filed:** **Jun. 9, 2010**

(51) **LOC (9) Cl.** ..... **14-01**

(52) **U.S. Cl.** ..... **D14/226**

(58) **Field of Classification Search** ..... D14/137,  
D14/138, 159, 168, 191, 431, 225–229, 224,  
D14/242, 155, 167, 203.3, 194, 192, 496;  
D13/168; D12/417; 340/825.69; 381/364,  
381/365; 455/95, 569.1; 348/148; 84/320

See application file for complete search history.

(56) **References Cited**

**U.S. PATENT DOCUMENTS**

D140,684 S *	3/1945	Braun	.....	D14/225
D163,695 S *	6/1951	Heineman	.....	D14/225
D164,869 S *	10/1951	Lapteff	.....	D14/225
D244,700 S *	6/1977	Pulos et al.	.....	D14/225
D355,915 S *	2/1995	Chan	.....	D14/225
D472,233 S *	3/2003	Hovanky et al.	.....	D14/225
D504,419 S *	4/2005	Bey et al.	.....	D14/223

D517,440 S *	3/2006	Gehalo et al.	.....	D10/106.1
D540,313 S *	4/2007	Rausch et al.	.....	D14/225
D572,706 S *	7/2008	Schaefer	.....	D14/225
D573,588 S *	7/2008	Warren et al.	.....	D14/225
7,427,705 B2 *	9/2008	Rubens	.....	84/320
D605,638 S *	12/2009	Vasilkov	.....	D14/225

\* cited by examiner

*Primary Examiner* — Austin Murphy

(74) *Attorney, Agent, or Firm* — Larson & Larson, P.A.;  
Frank Liebenow; Justin P. Miller

(57) **CLAIM**

I claim the ornamental design for a acoustic guitar micro-  
phone, as shown and described.

**DESCRIPTION**

FIG. 1 is a front elevation view of the acoustic guitar micro-  
phone showing my novel design;  
FIG. 2 is a rear plan view thereof;  
FIG. 3 is a left side elevation view thereof;  
FIG. 4 is a right side elevation view thereof;  
FIG. 5 is a top elevation view thereof;  
FIG. 6 is a bottom elevation view thereof; and,  
FIG. 7 is a perspective view thereof.

**1 Claim, 4 Drawing Sheets**

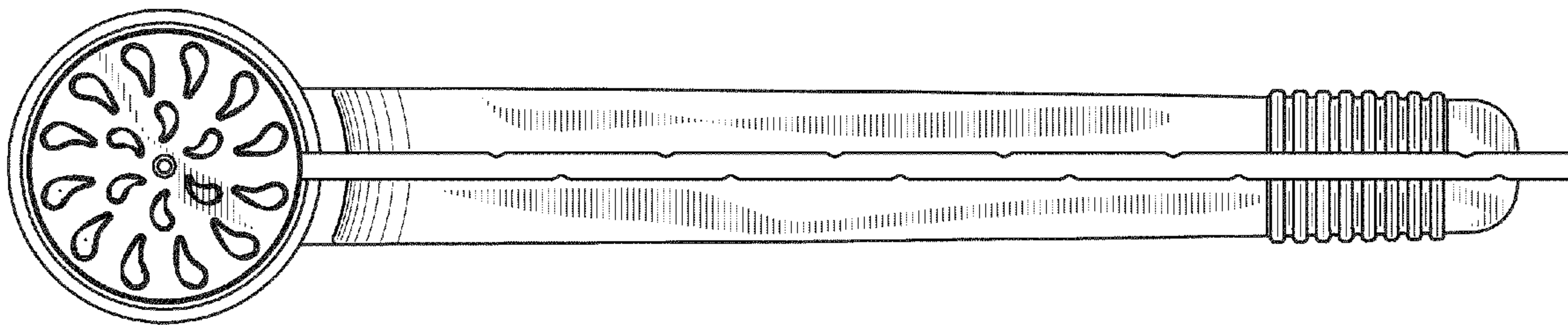

FIG. 1

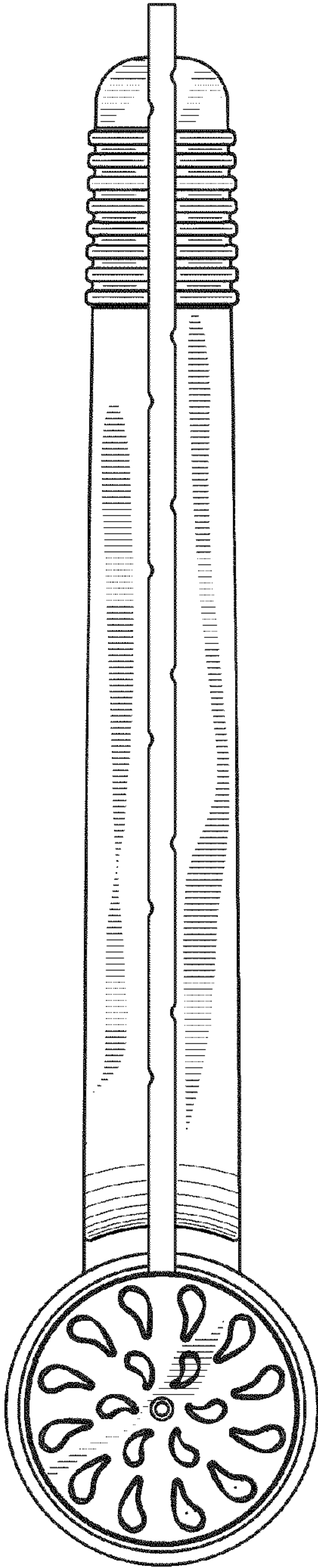

FIG. 2

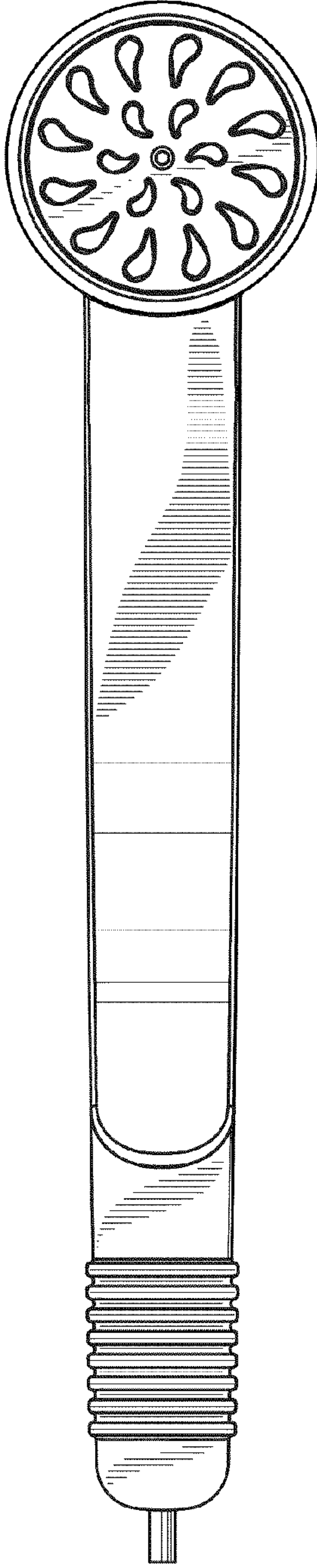

FIG. 3

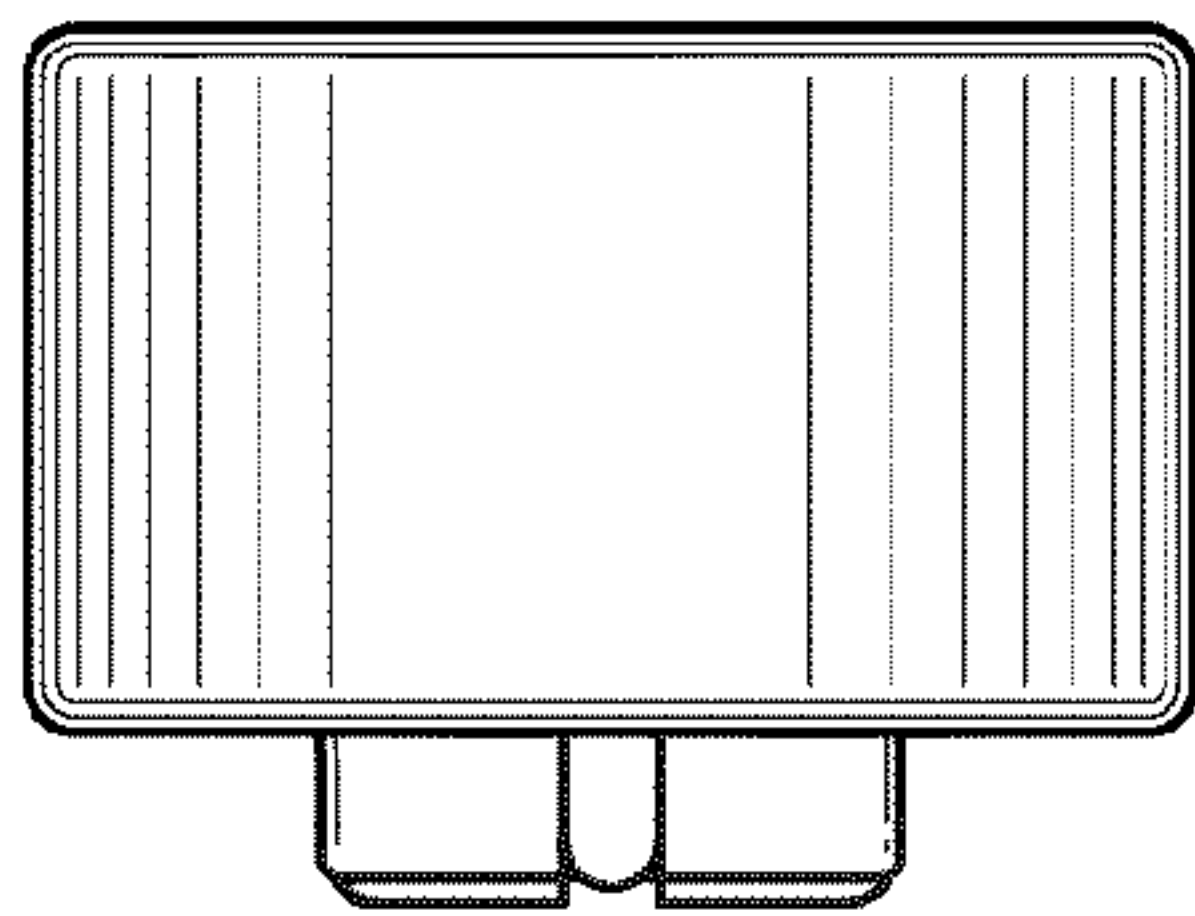

FIG. 4

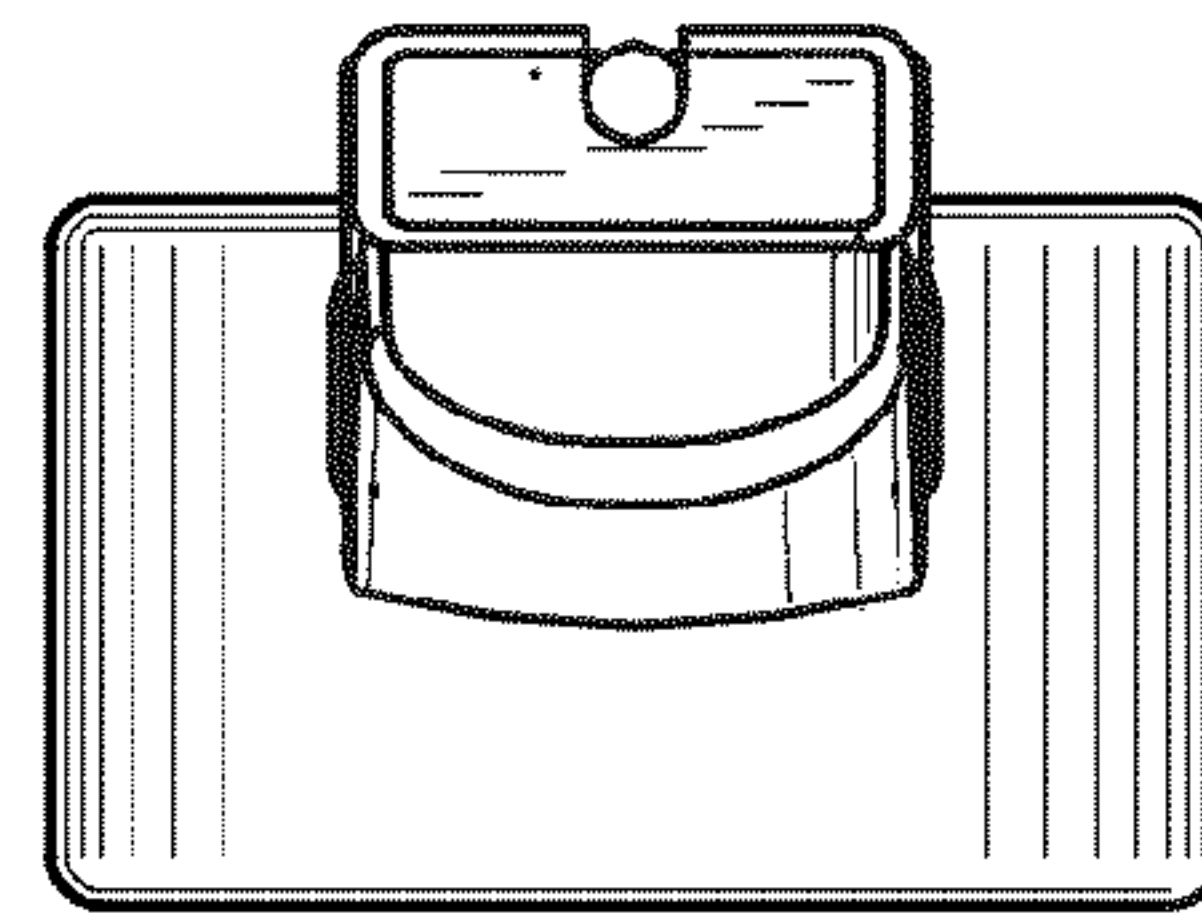

FIG. 5

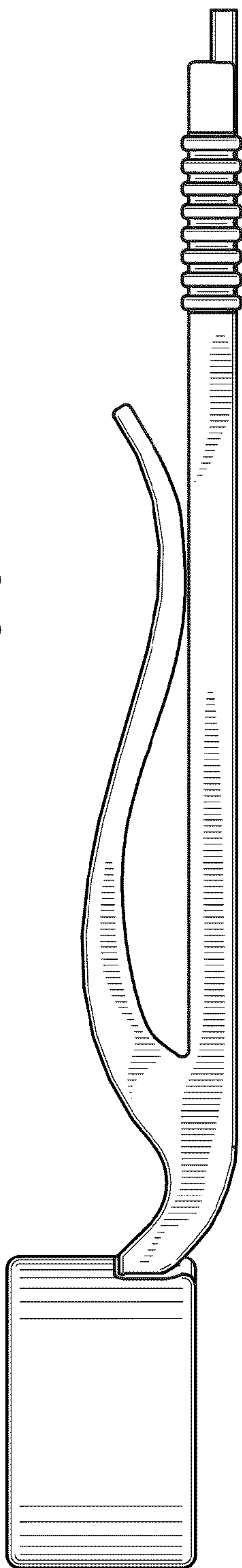
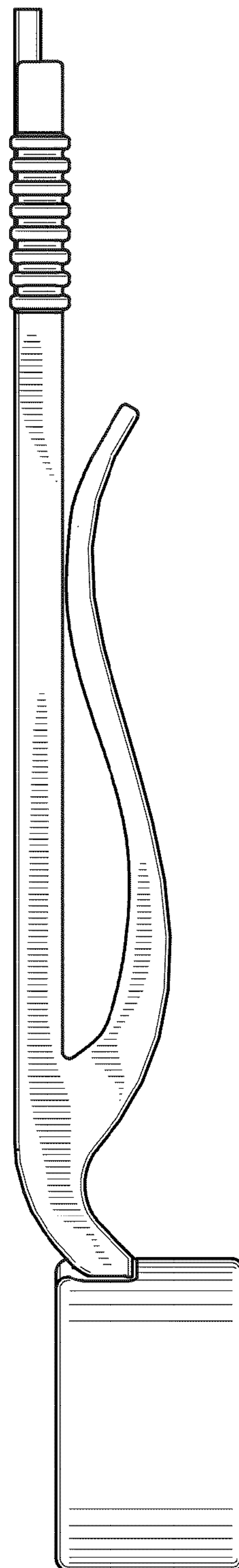

FIG. 6





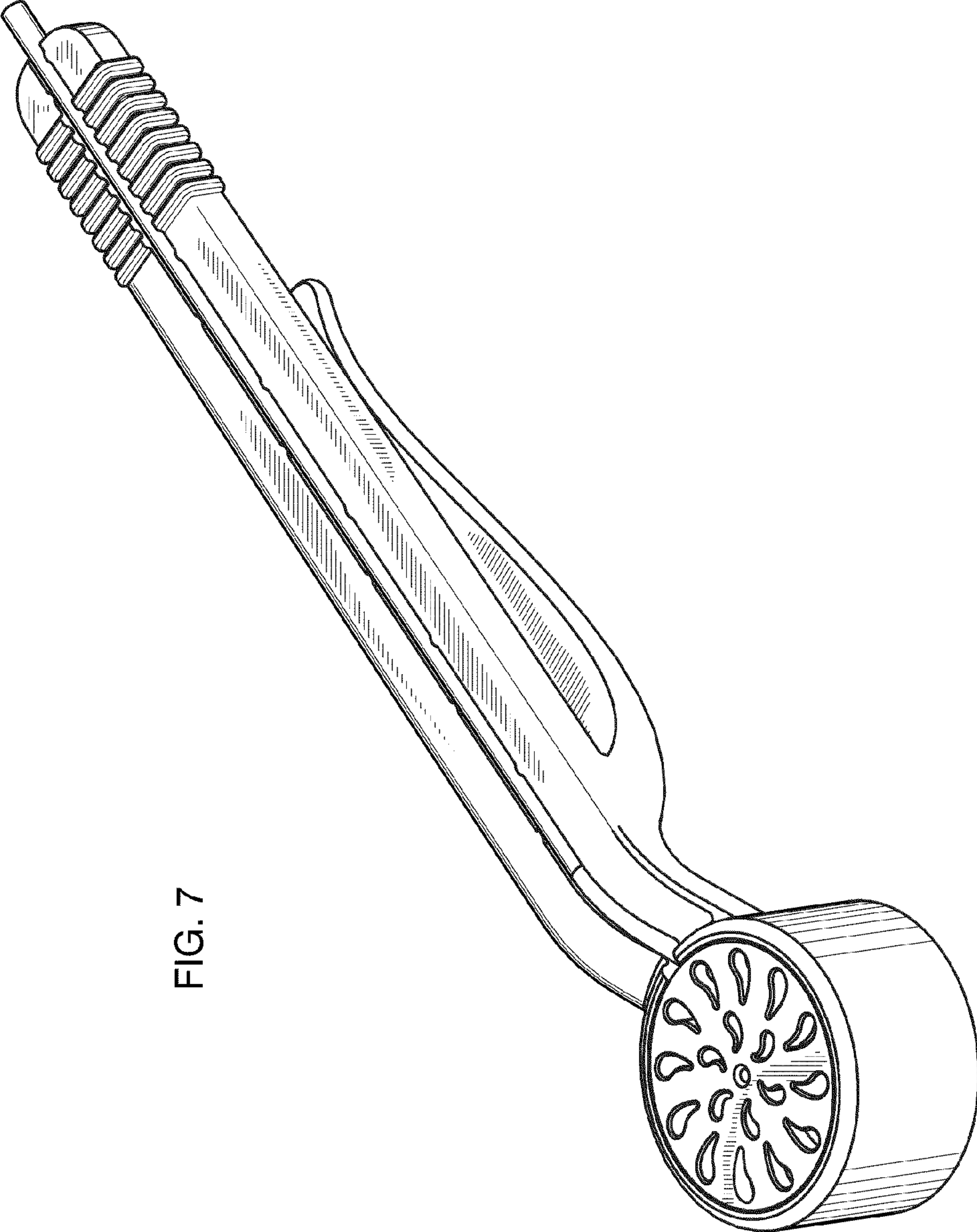

FIG. 7