



US00D652823S

(12) **United States Design Patent**  
**Chen**

(10) **Patent No.:** **US D652,823 S**

(45) **Date of Patent:** **\*\* Jan. 24, 2012**

(54) **EARPHONE**

(75) Inventor: **Hwang-Miaw Chen**, Tu-Cheng (TW)

(73) Assignee: **Hon Hai Precision Industry Co., Ltd.**,  
Tu-Cheng, New Taipei (TW)

(\*\*) Term: **14 Years**

(21) Appl. No.: **29/389,697**

(22) Filed: **Apr. 15, 2011**

(51) **LOC (9) Cl.** ..... **14-01**

(52) **U.S. Cl.** ..... **D14/223**

(58) **Field of Classification Search** ..... D14/205,  
D14/206, 223, 216, 265, 209.1, 248, 204,  
D14/221, 224.1; 379/430, 431, 428.01, 428.02,  
379/433.02; 381/370, 380, 381, 371, 397,  
381/385, 412; D24/106, 174; D29/112,  
D29/122; 128/865, 866

See application file for complete search history.

(56) **References Cited**

**U.S. PATENT DOCUMENTS**

3,934,100	A *	1/1976	Harada	.....	181/135
D278,234	S *	4/1985	Saito	.....	D14/205
4,646,872	A *	3/1987	Kamon et al.	.....	181/129
4,965,838	A *	10/1990	Kamon et al.	.....	381/380
D318,864	S *	8/1991	Daido et al.	.....	D14/205
D318,865	S *	8/1991	Ichikawa	.....	D14/205
5,133,428	A *	7/1992	Perrson	.....	181/153
D334,043	S *	3/1993	Taniguchi et al.	.....	D14/218
5,420,935	A *	5/1995	Shinohara et al.	.....	381/370
6,122,369	A *	9/2000	Hwang et al.	.....	379/420.04
D469,753	S *	2/2003	Andre et al.	.....	D14/205
6,560,344	B1 *	5/2003	Julstrom et al.	.....	381/356
D519,109	S *	4/2006	Perszyk et al.	.....	D14/223
D523,846	S *	6/2006	Lee	.....	D14/205

D531,169	S *	10/2006	Tokioka et al.	.....	D14/223
7,289,640	B2 *	10/2007	Tsai et al.	.....	381/380
D556,741	S *	12/2007	Yeo	.....	D14/223
D593,537	S *	6/2009	Arimoto	.....	D14/205
D615,070	S *	5/2010	Andre et al.	.....	D14/223
D625,709	S *	10/2010	Yamamoto	.....	D14/223

\* cited by examiner

*Primary Examiner* — Paula Greene

(74) *Attorney, Agent, or Firm* — Altis Law Group, Inc.

(57) **CLAIM**

The ornamental design for an earphone, as shown and described.

**DESCRIPTION**

FIG. 1 is a perspective view of an embodiment of an earphone showing my new design.

FIG. 2 is a front elevational view of the earphone of FIG. 1.

FIG. 3 is a rear elevational view of the earphone of FIG. 1.

FIG. 4 is a left side elevational view of the earphone of FIG. 1.

FIG. 5 is a right side elevational view of the earphone of FIG. 1.

FIG. 6 is a top plan view of the earphone of FIG. 1.

FIG. 7 is a bottom plan view of the earphone of FIG. 1.

FIG. 8 is a perspective view of an alternative embodiment of an earphone showing my new design.

FIG. 9 is a front elevational view of the earphone of FIG. 8.

FIG. 10 is a rear elevational view of the earphone of FIG. 8.

FIG. 11 is a left side elevational view of the earphone of FIG. 8.

FIG. 12 is a right side elevational view of the earphone of FIG. 8.

FIG. 13 is a top plan view of the earphone of FIG. 8; and,

FIG. 14 is a bottom plan view of the earphone of FIG. 8.

Portions of FIGS. 1 to 14 that are shown as broken lines are for illustrative purpose only and form no part of the claimed design.

**1 Claim, 14 Drawing Sheets**

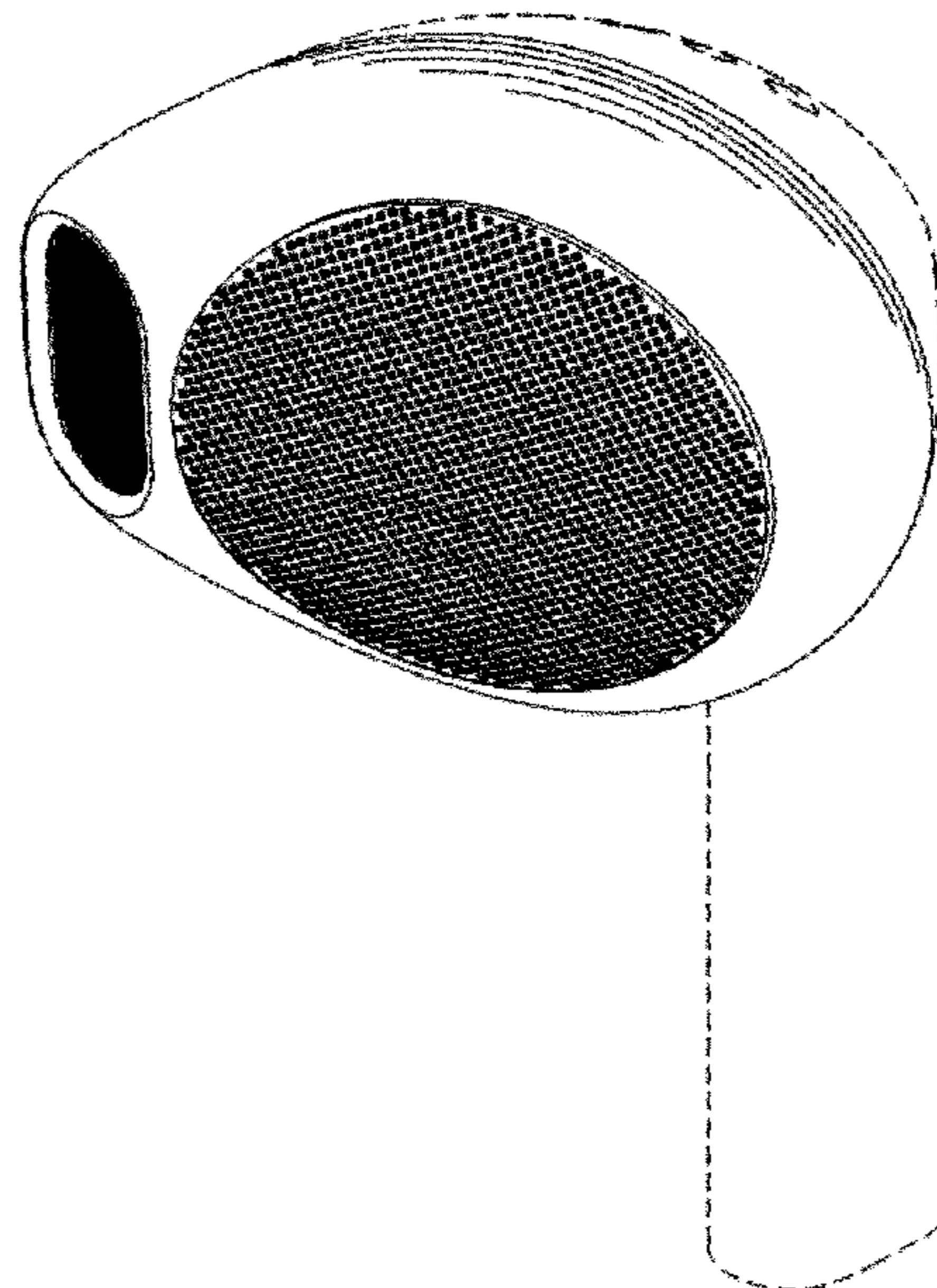
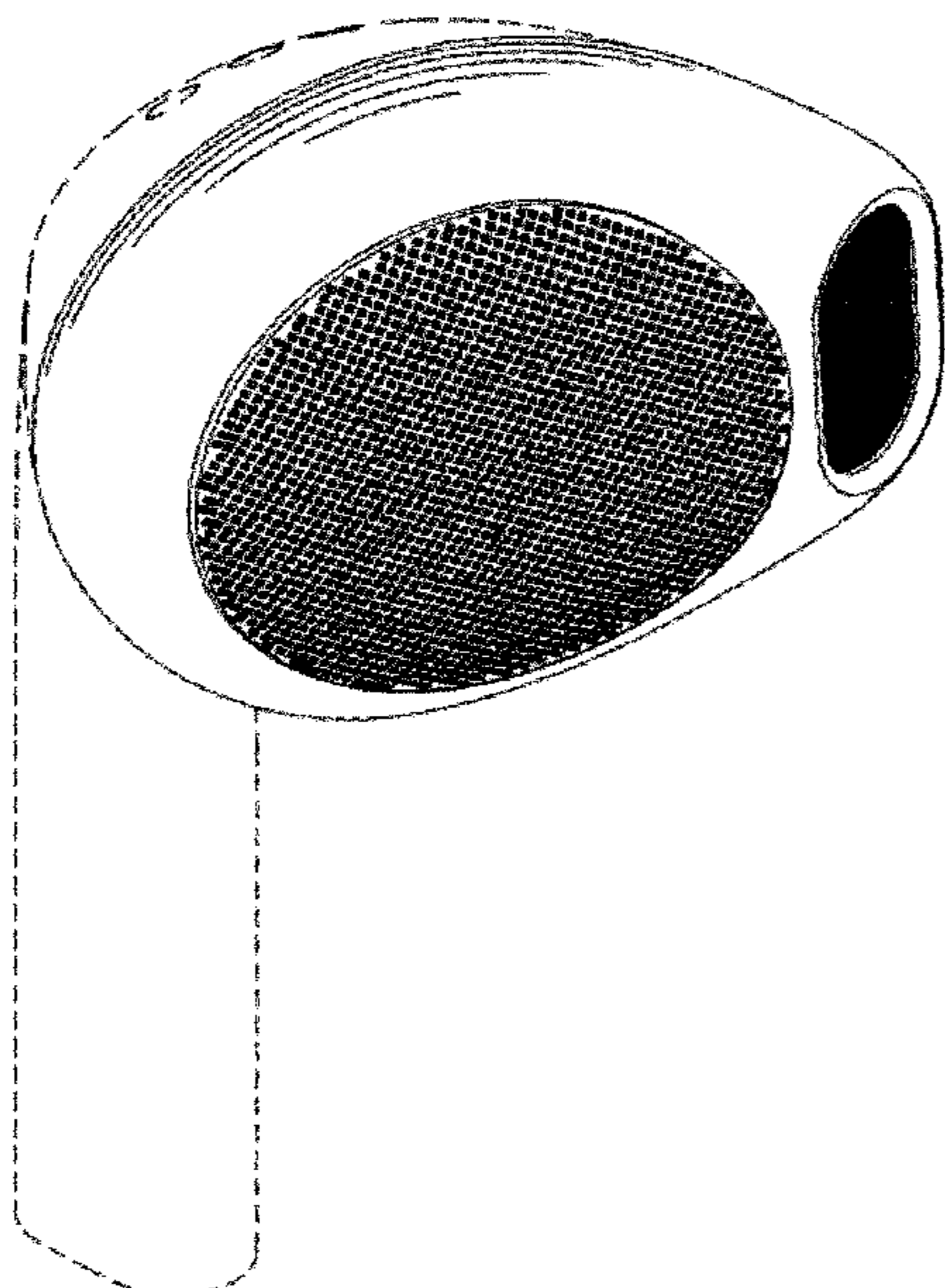



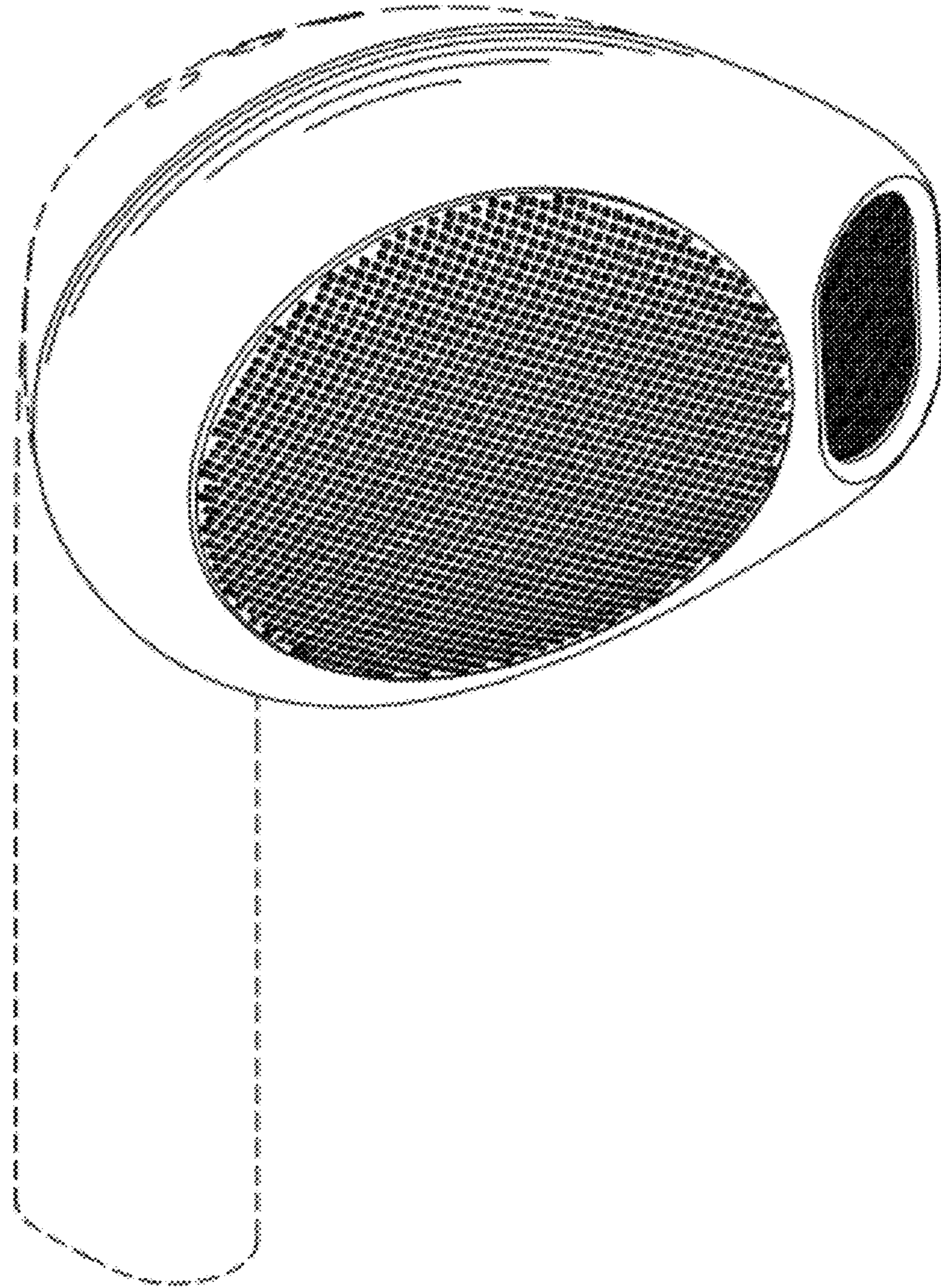

FIG. 1

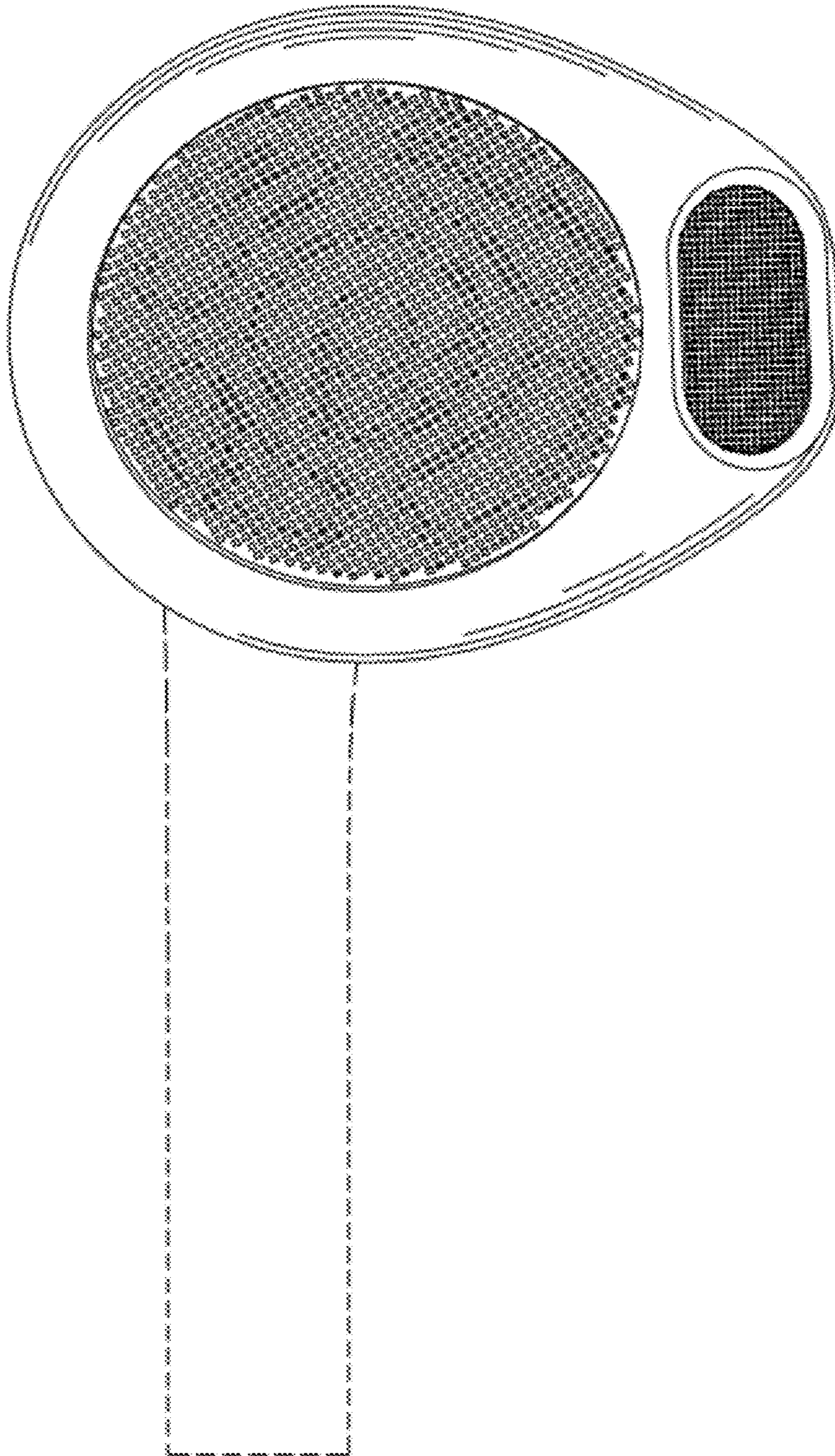

FIG. 2



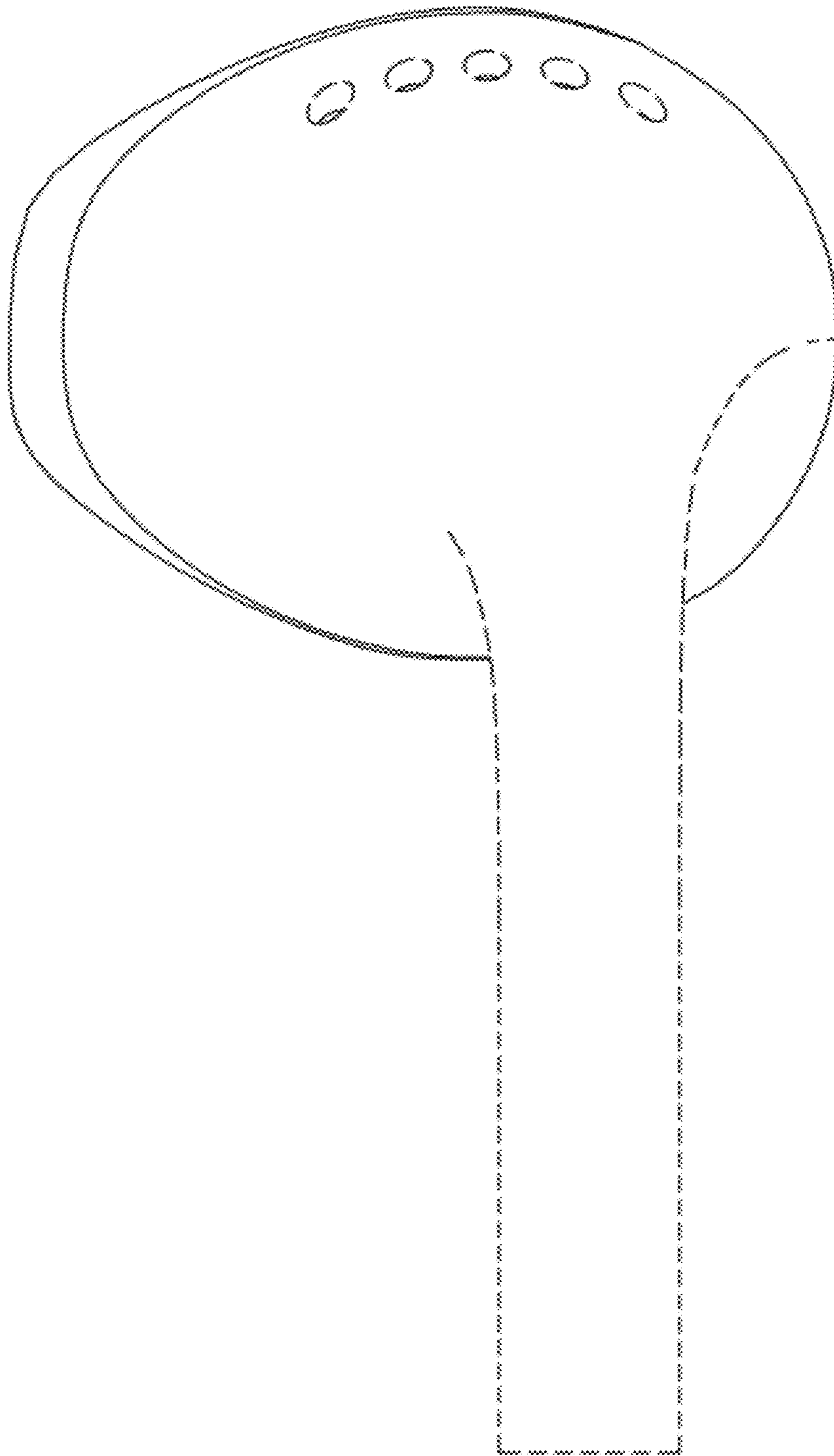

FIG. 3

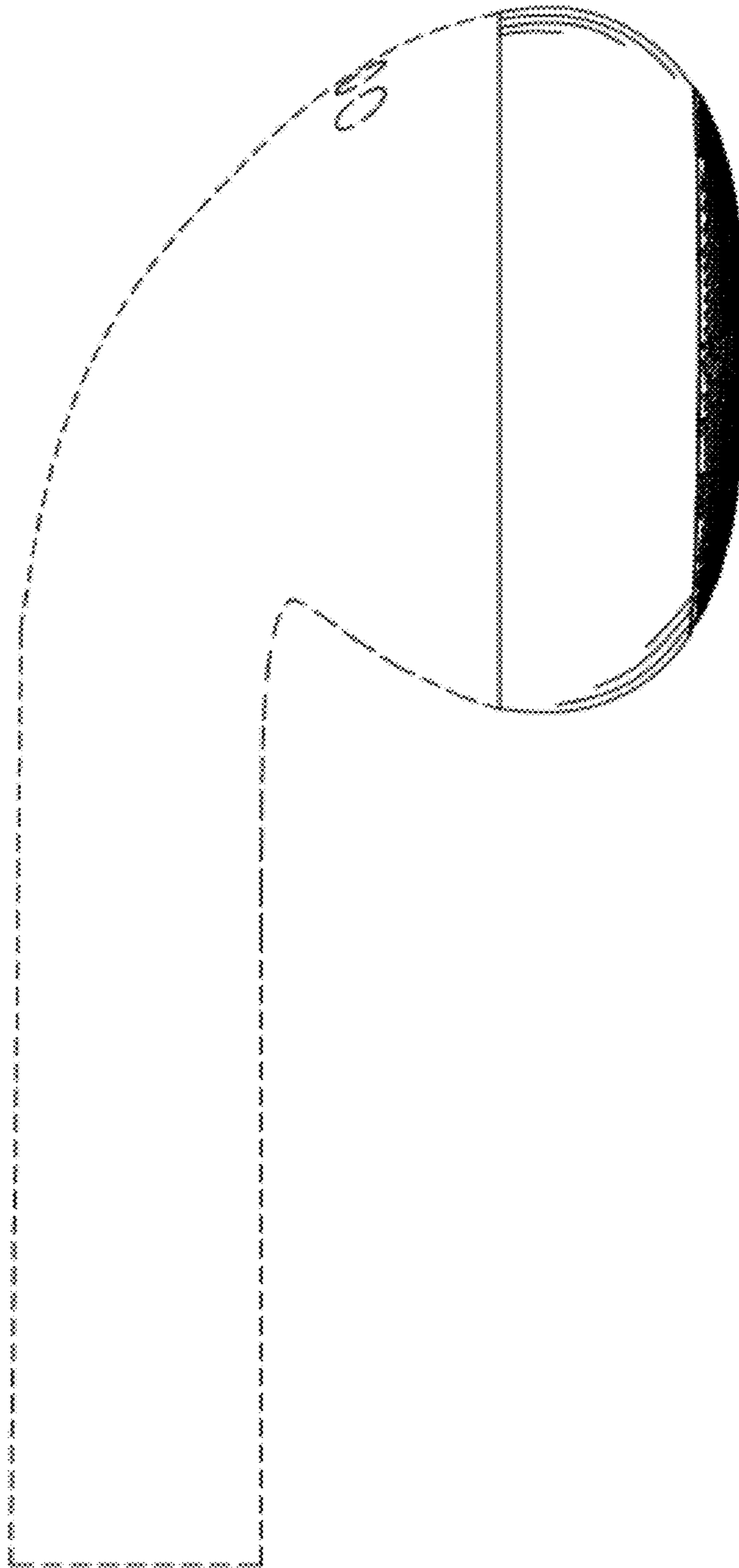

FIG. 4

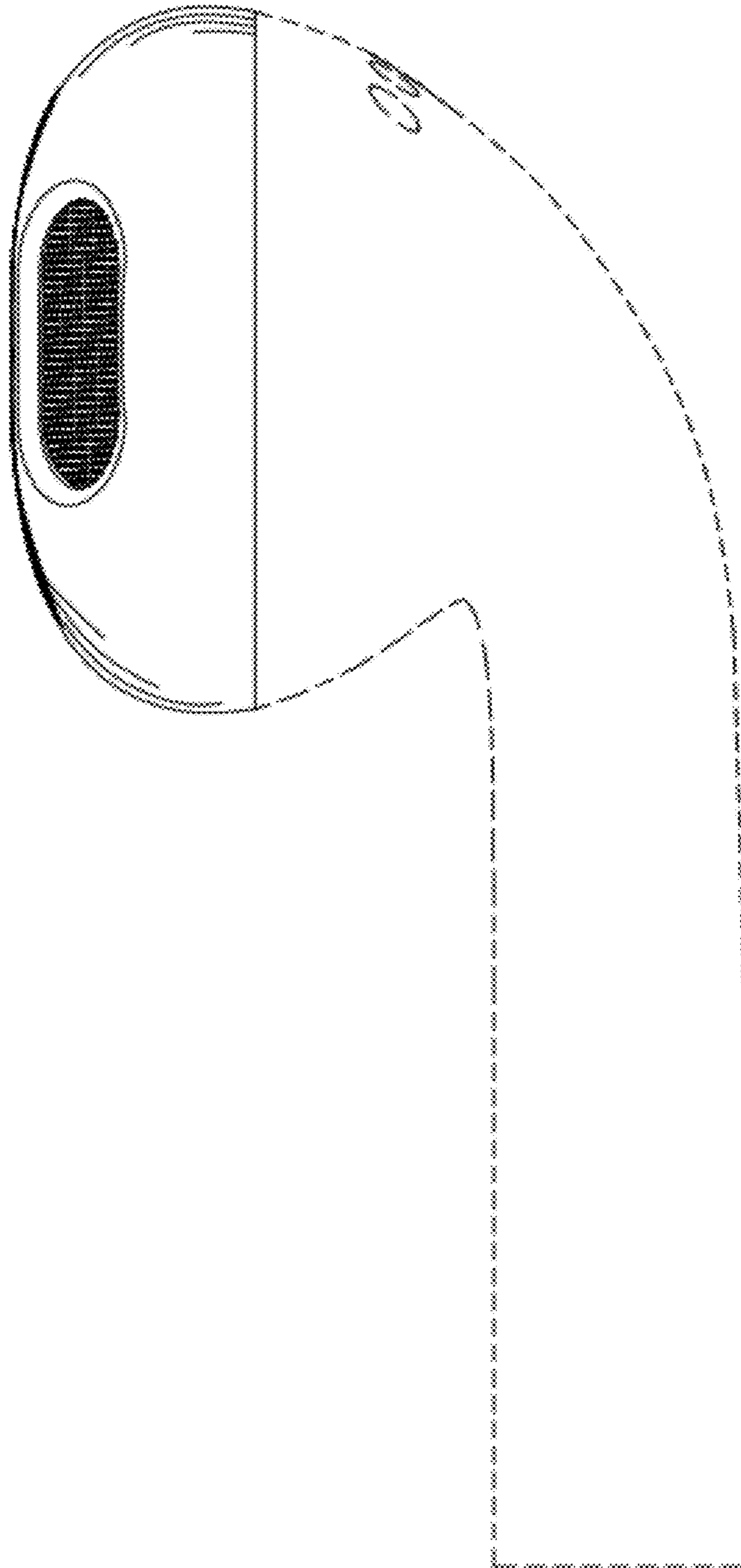

FIG. 5

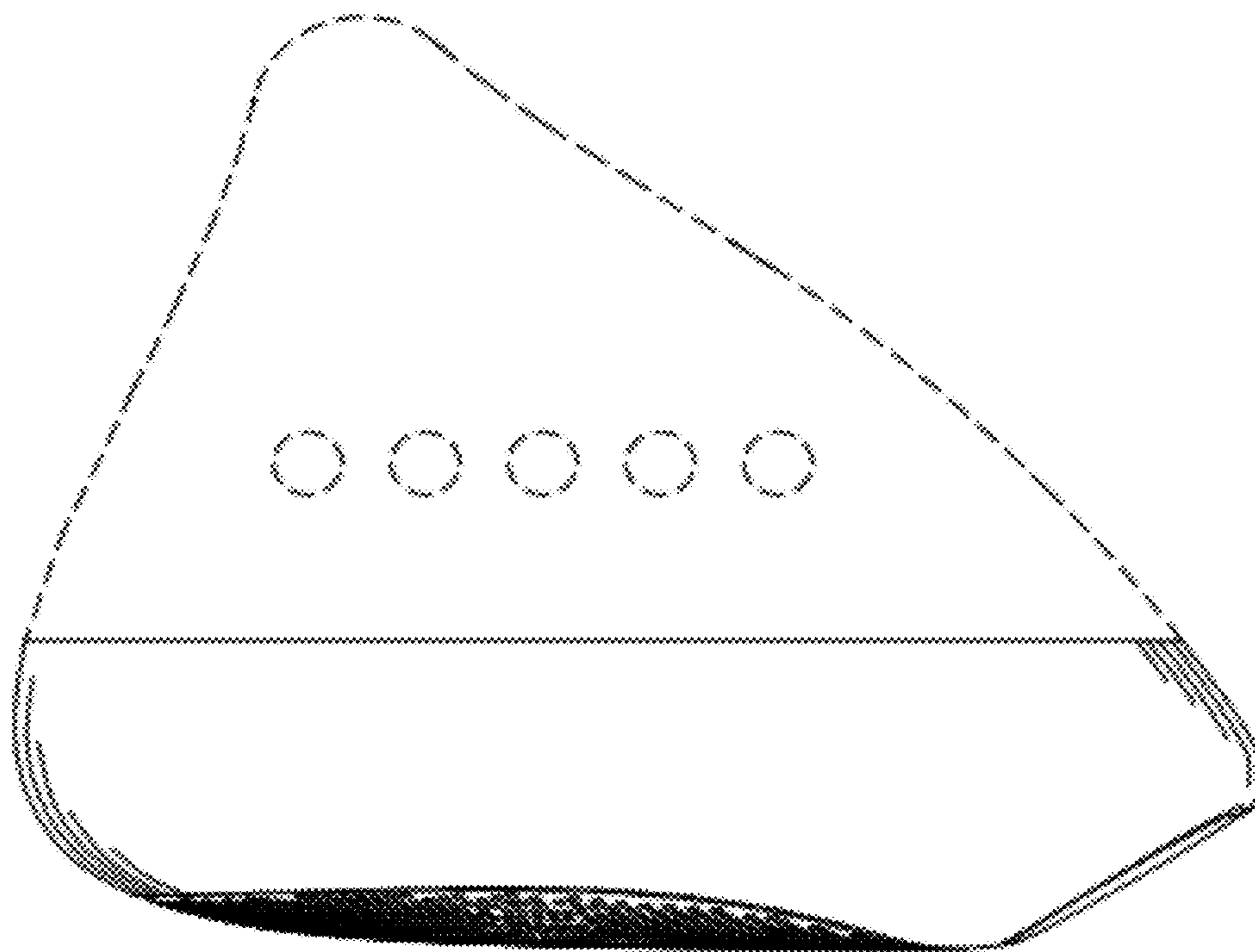

FIG. 6

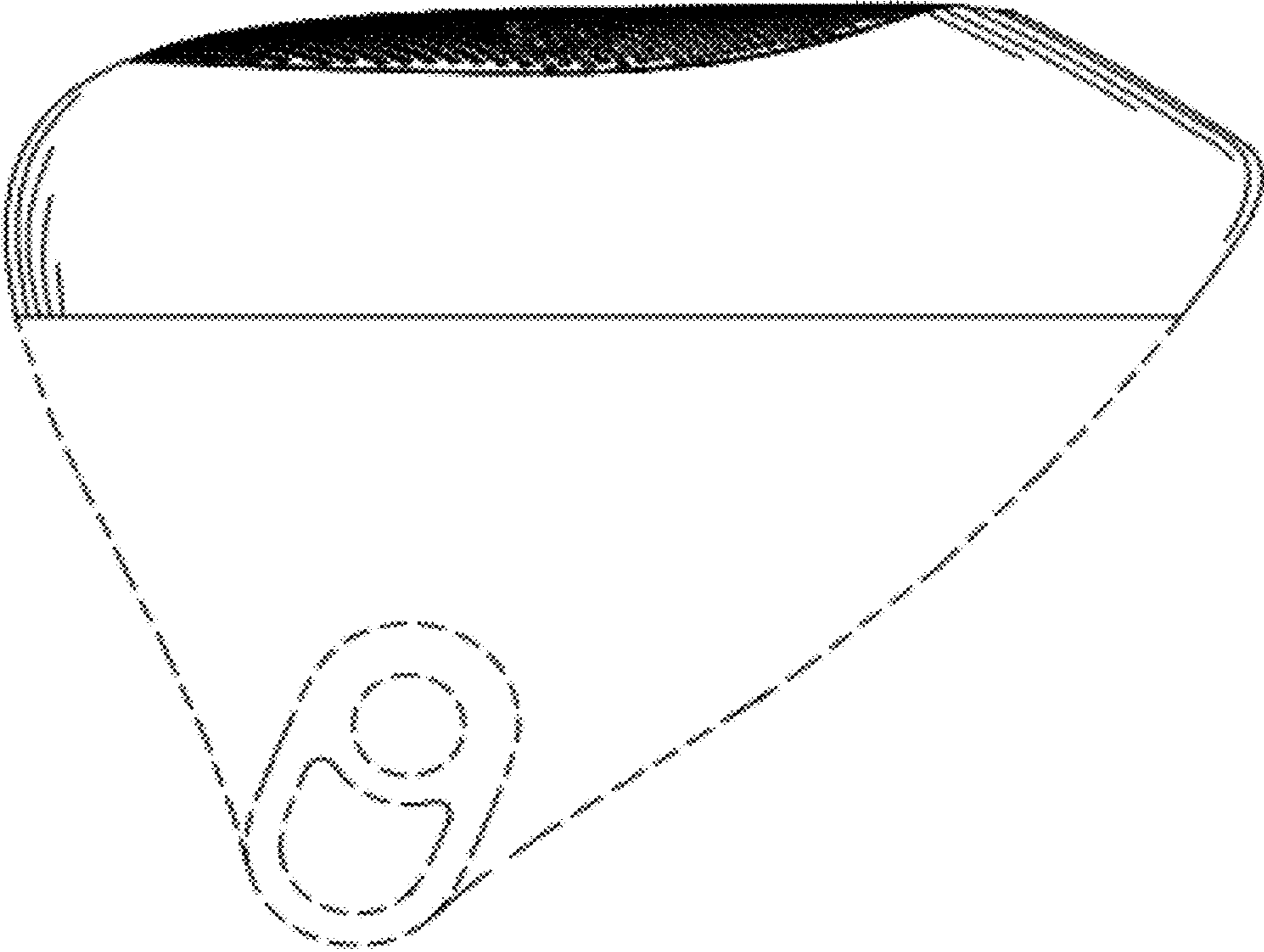

FIG. 7



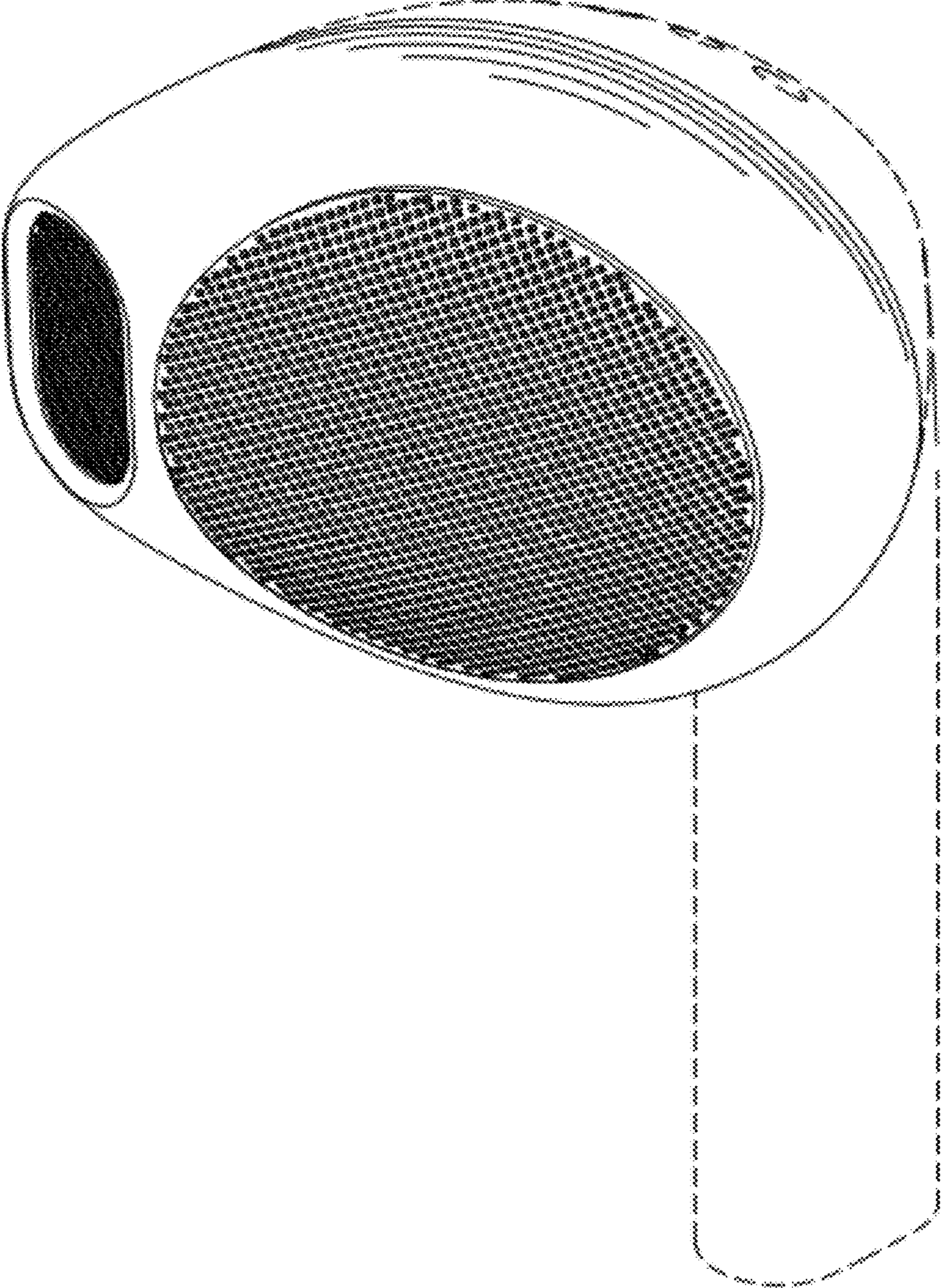

FIG. 8



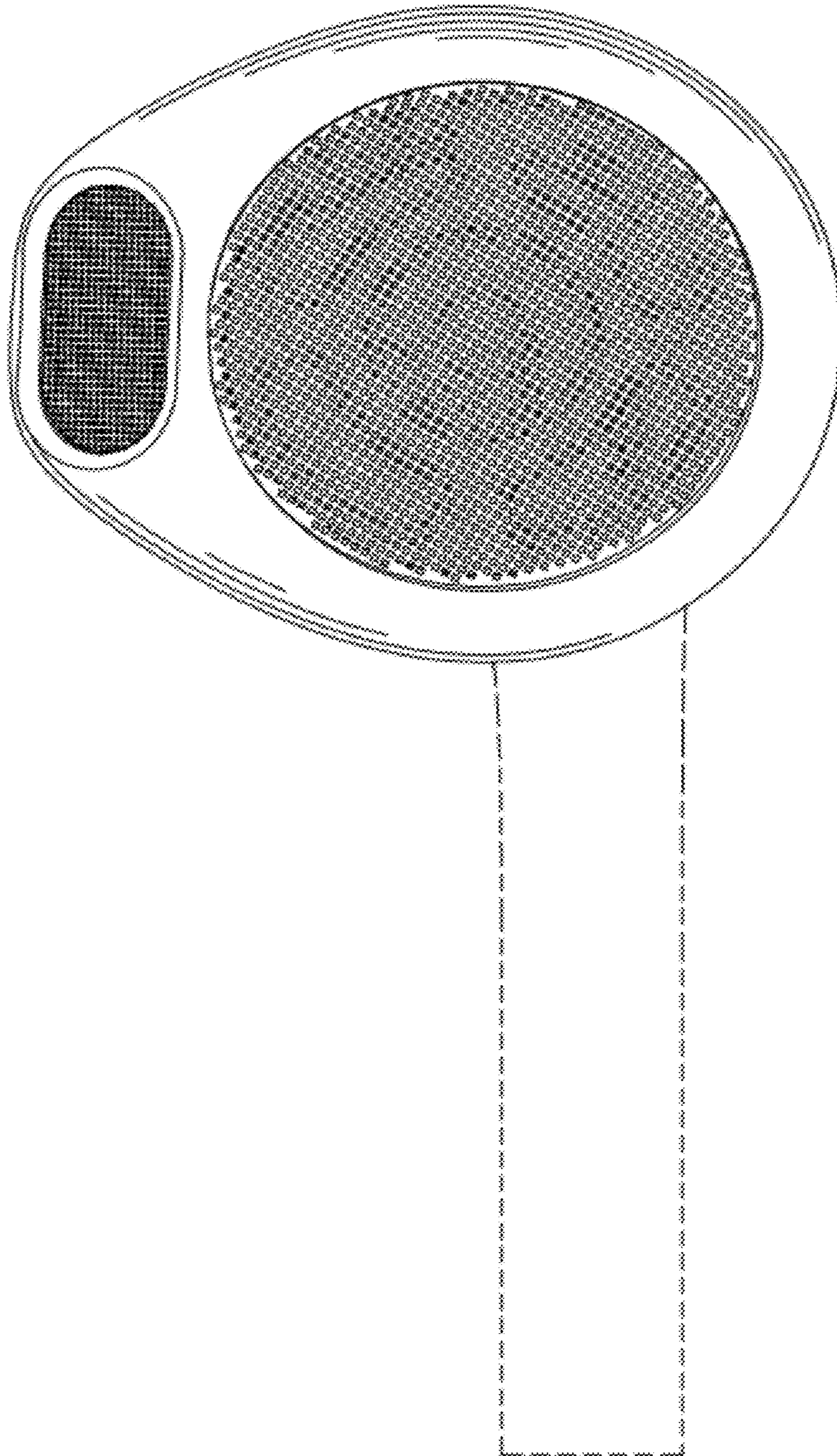

FIG. 9

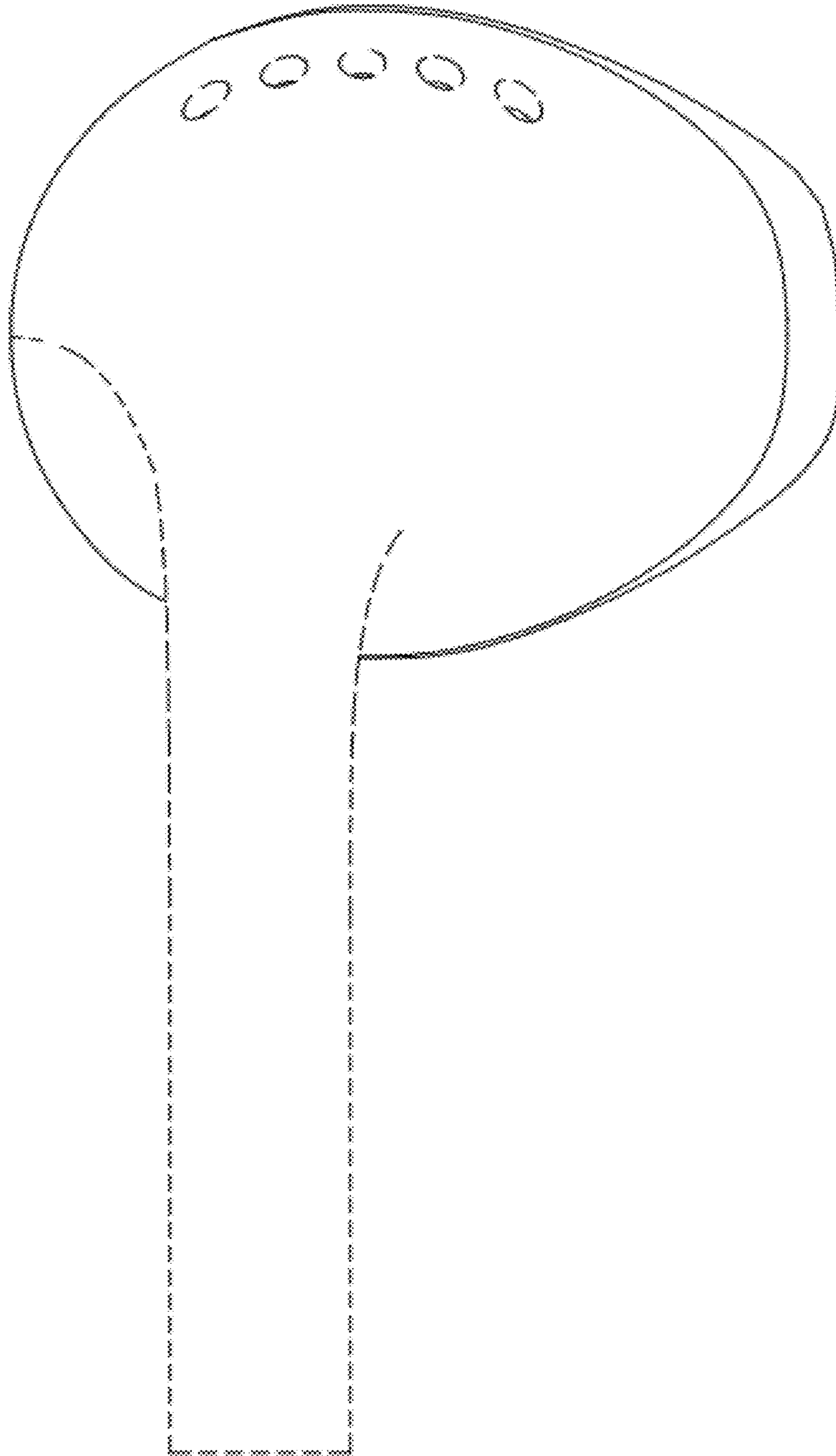

FIG. 10



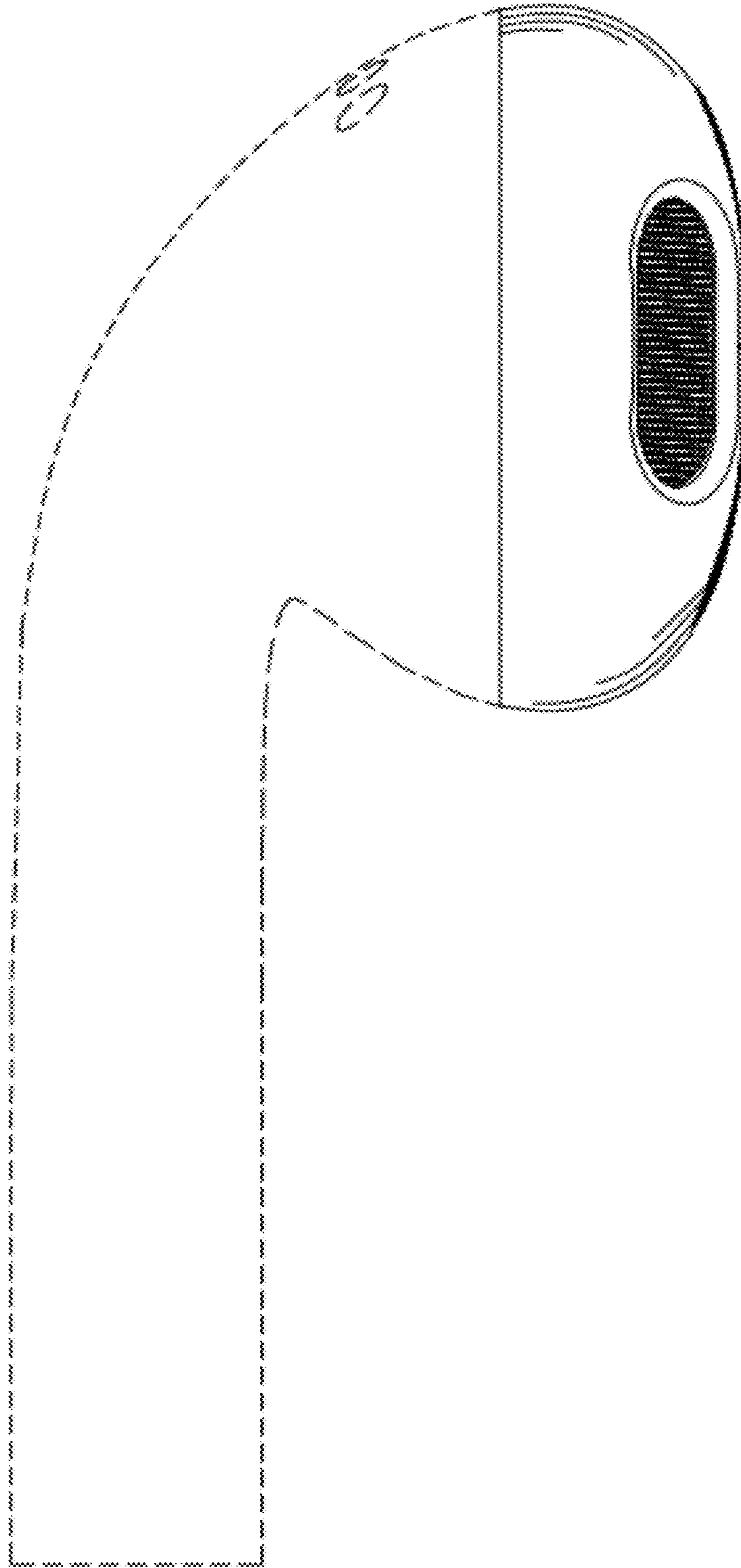

FIG. 11

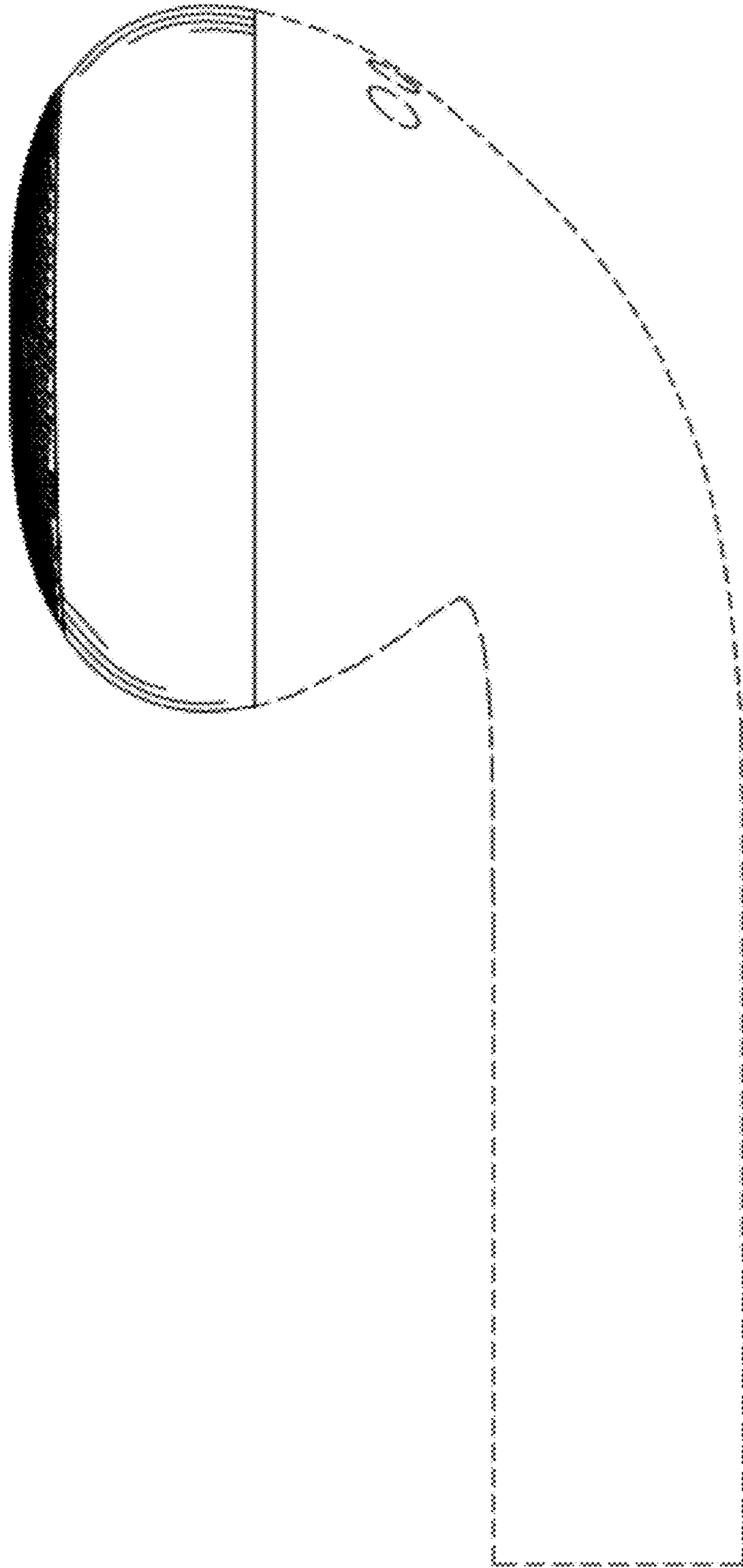

FIG. 12

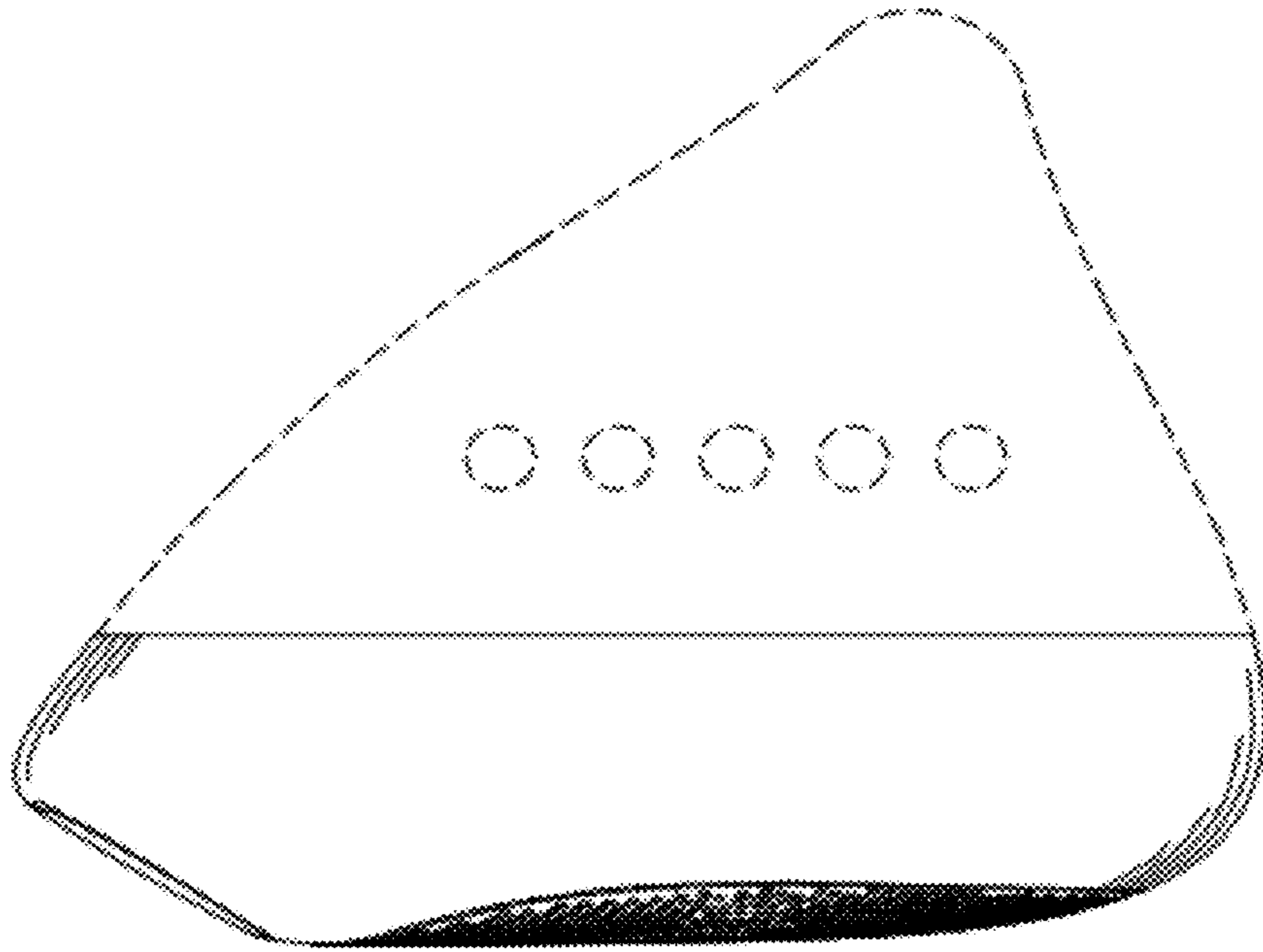

FIG. 13



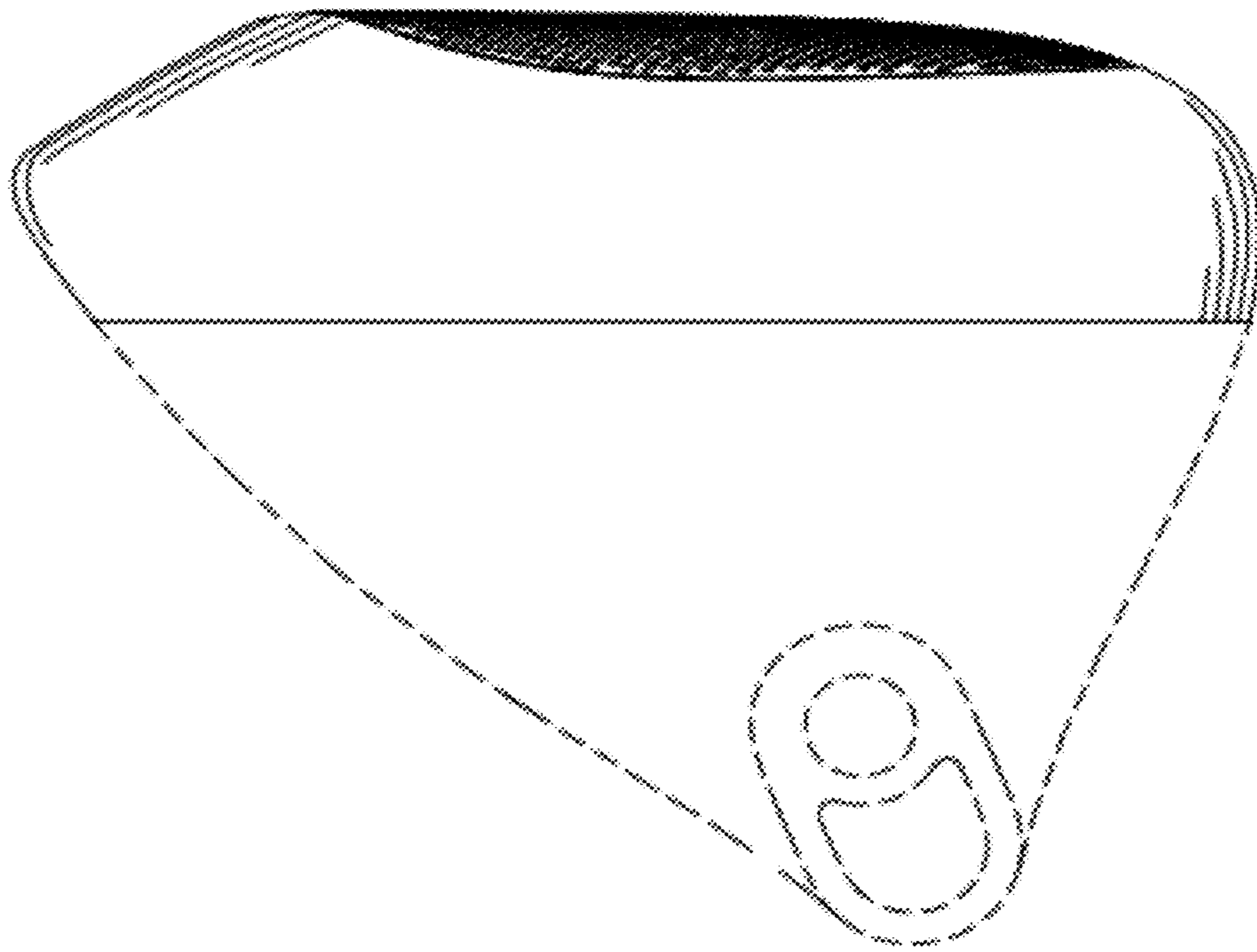

FIG. 14