



US00D652753S

(12) **United States Design Patent**
Deyaf

(10) **Patent No.:** **US D652,753 S**

(45) **Date of Patent:** **** *Jan. 24, 2012**

(54) **EMERGENCY VEHICLE LIGHT-BAR**

(56) **References Cited**

(75) **Inventor:** **Ahmed Deyaf**, Richardson, TX (US)

U.S. PATENT DOCUMENTS

(73) **Assignee:** **Speedtech Lights Inc.**, Buda, TX (US)

| | | | | | | |
|----------|---|---|--------|--------|-------|---------|
| D545,230 | S | * | 6/2007 | Jalala | | D10/114 |
| D584,981 | S | * | 1/2009 | Shin | | D10/114 |
| D585,318 | S | * | 1/2009 | Jalala | | D10/114 |
| D598,800 | S | * | 8/2009 | Shin | | D10/114 |

(*) **Notice:** This patent is subject to a terminal disclaimer.

* cited by examiner

Primary Examiner — George D Kirschbaum

(**) **Term:** **14 Years**

(57) **CLAIM**

The ornamental design for an emergency vehicle light-bar, as shown.

(21) **Appl. No.:** **29/353,839**

DESCRIPTION

(22) **Filed:** **Jan. 14, 2010**

(51) **LOC (9) Cl.** **10-05**

(52) **U.S. Cl.** **D10/114.4**

(58) **Field of Classification Search** D10/114;

D26/72, 85, 29-31, 60; 362/540-549

FIG. 1 is a perspective view of an emergency vehicle light-bar showing my new design;
FIG. 2 is a front view thereof;
FIG. 3 is a back view thereof;
FIG. 4 is a right side view thereof;
FIG. 5 is a left side view thereof;
FIG. 6 is a top view thereof; and,
FIG. 7 is a bottom view thereof.
The broken lines depict unclaimed environmental subject matter.

See application file for complete search history.

1 Claim, 3 Drawing Sheets

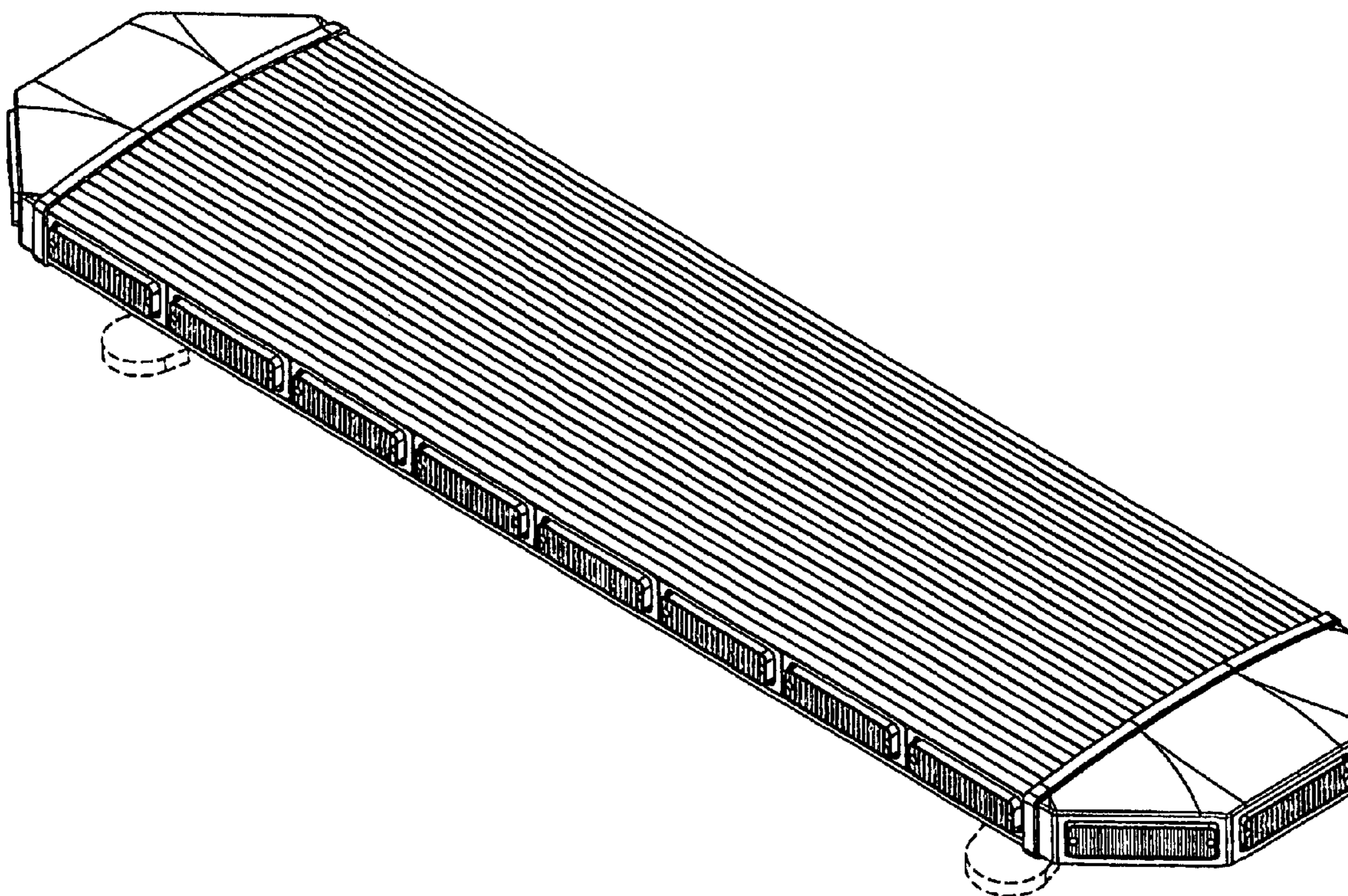

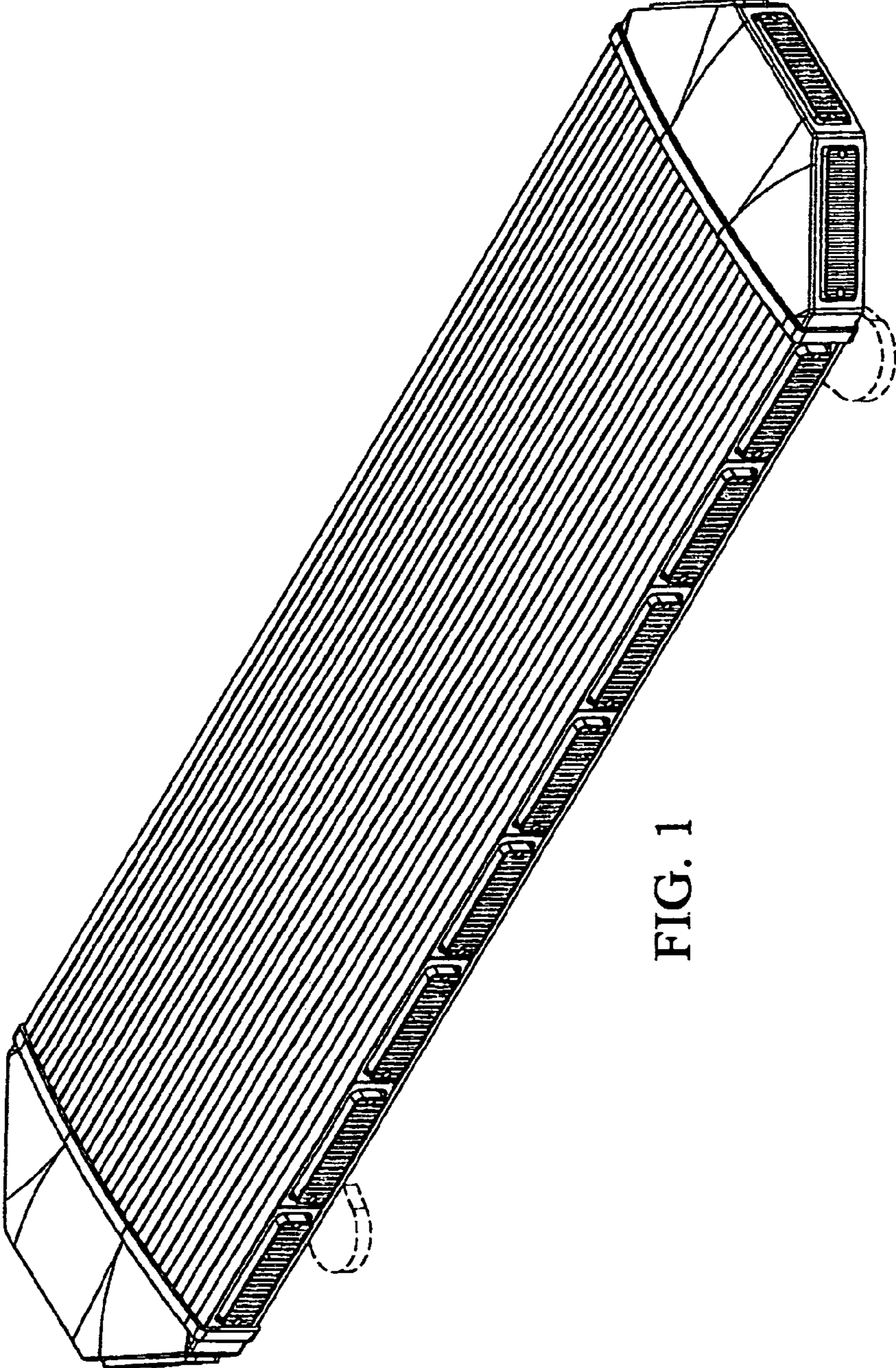

FIG. 1

FIG. 2

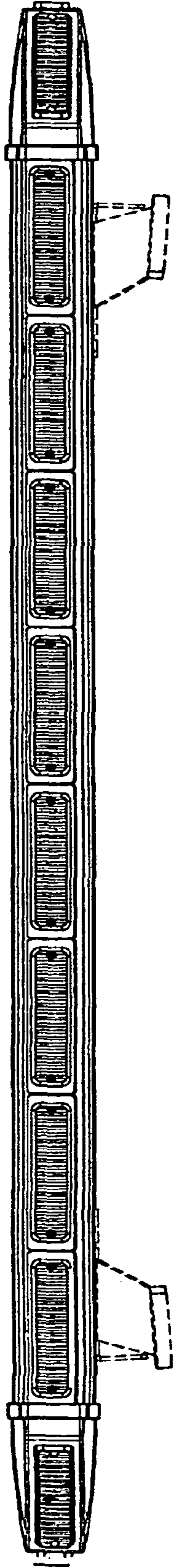

FIG. 3

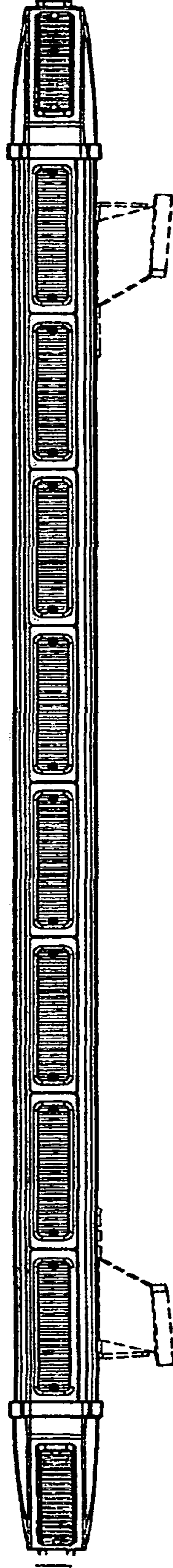

FIG. 4

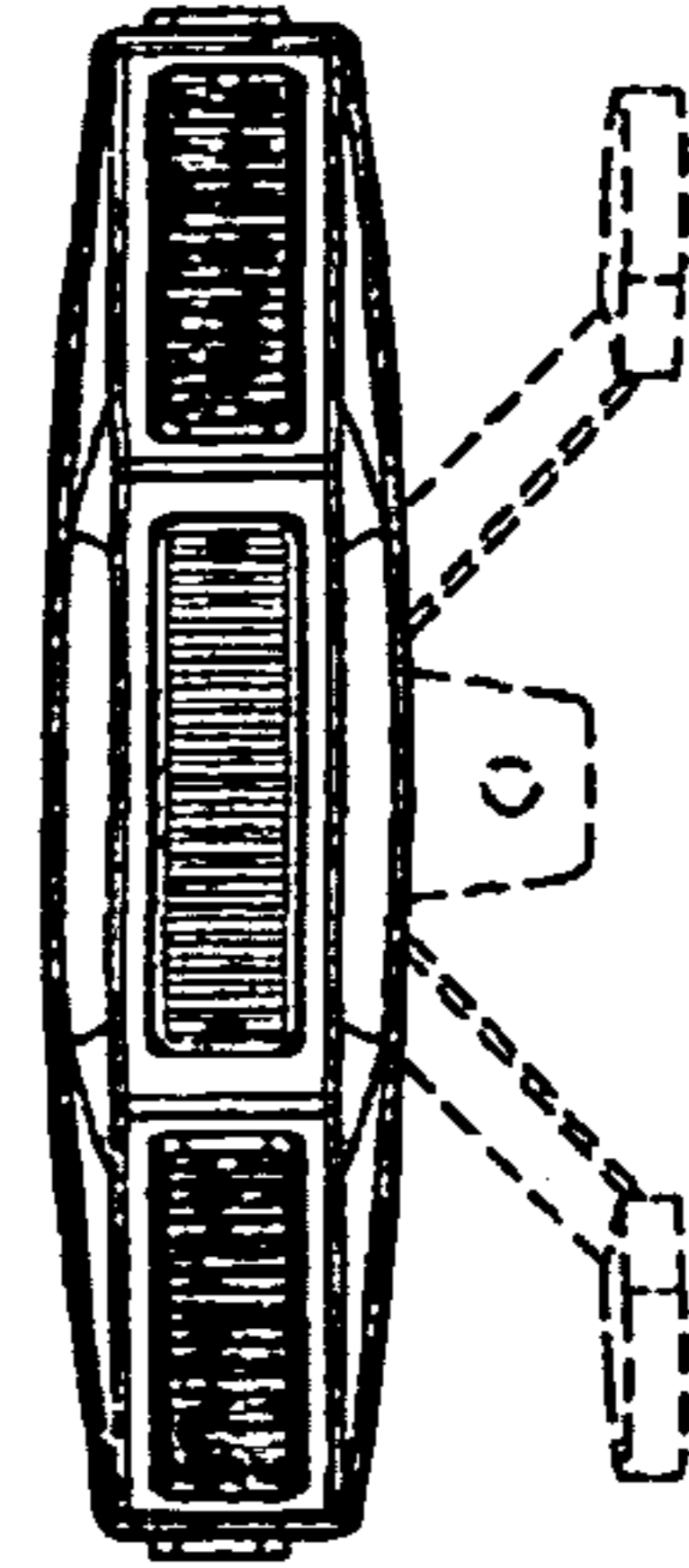

FIG. 5

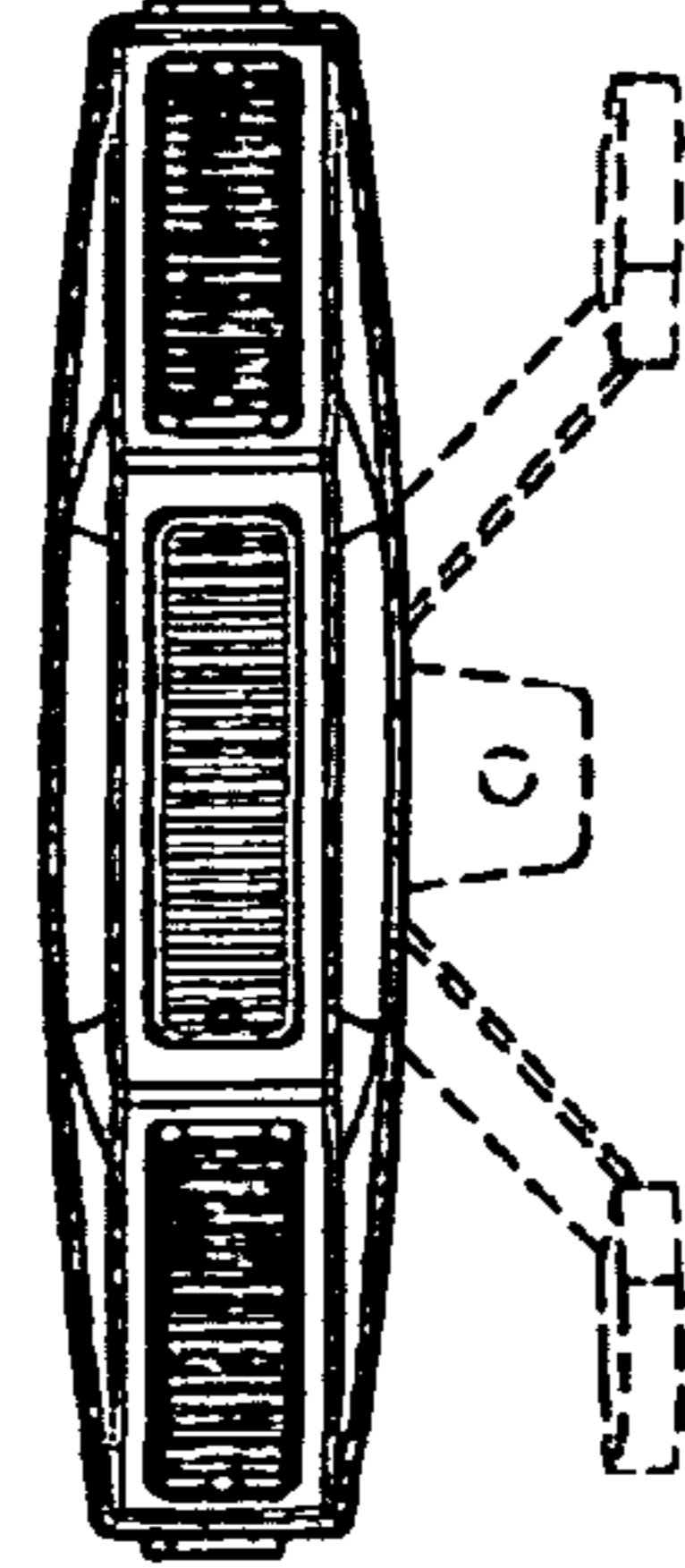

FIG. 6

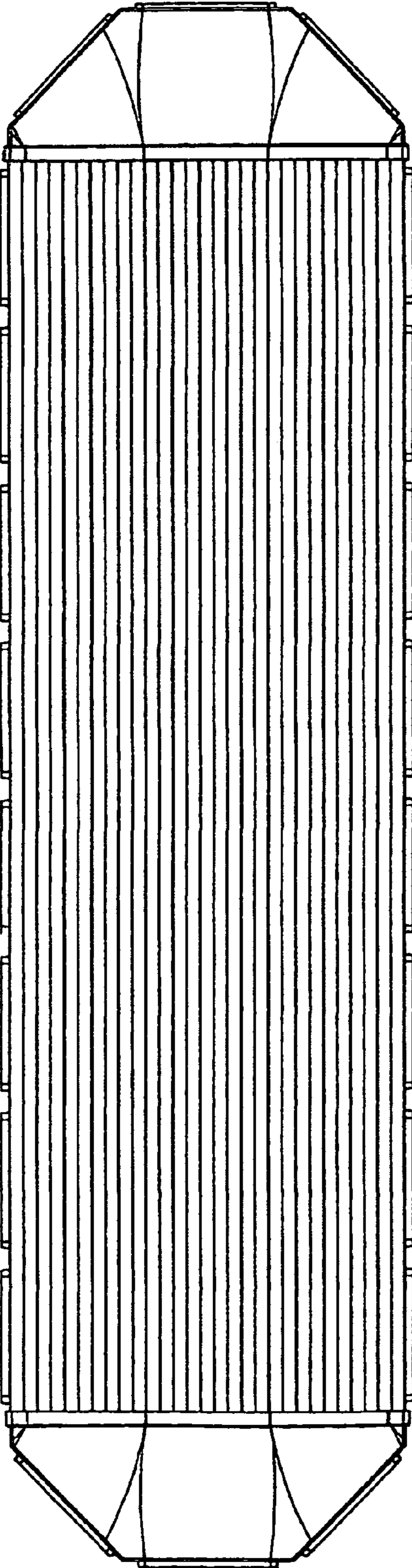

FIG. 7

