



US00D652626S

(12) **United States Design Patent**
Gebski

(10) **Patent No.:** **US D652,626 S**
(45) **Date of Patent:** **** Jan. 24, 2012**

(54) **BRUSH HEAD FOR ELECTRIC TOOTHBRUSH**

(75) Inventor: **Edouard Gebski**, Amersfoort (NL)

(73) Assignee: **Koninklijke Philips Electronics N.V.**, Eindhoven (NL)

(**) Term: **14 Years**

(21) Appl. No.: **29/360,064**

(22) Filed: **Apr. 20, 2010**

(51) **LOC (9) Cl.** **04-02**

(52) **U.S. Cl.** **D4/101**

(58) **Field of Classification Search** D4/101,
D4/104-112, 134; 15/167.1, 167.2, 176.1;
132/308-311; 601/139, 141, 142

See application file for complete search history.

(56) **References Cited**

U.S. PATENT DOCUMENTS

D121,519 S * 7/1940 Mastrud D4/104
3,400,417 A * 9/1968 Moret 15/22.1
5,655,249 A * 8/1997 Li 15/167.1

D397,251 S * 8/1998 Eguchi et al. D4/101
D517,325 S * 3/2006 Black et al. D4/108
D569,623 S * 5/2008 Beedham D4/101
D579,664 S * 11/2008 Fisher et al. D4/101
D611,712 S * 3/2010 Stoerkel et al. D4/104

FOREIGN PATENT DOCUMENTS

KR 30-0324067 S * 5/2003
KR 30-0439339 S * 2/2007

* cited by examiner

Primary Examiner — Melanie H Tung

Assistant Examiner — Lavone D Tabor

(57) **CLAIM**

The ornamental design for a brush head for electric toothbrush, as shown.

DESCRIPTION

FIG. 1 is a perspective view showing my design;

FIG. 2 is a front elevational view thereof;

FIG. 3 is a rear elevational view thereof;

FIG. 4 is a right side elevational view thereof;

FIG. 5 is a left side elevational view thereof; and,

FIG. 6 is a top plan view thereof.

1 Claim, 3 Drawing Sheets

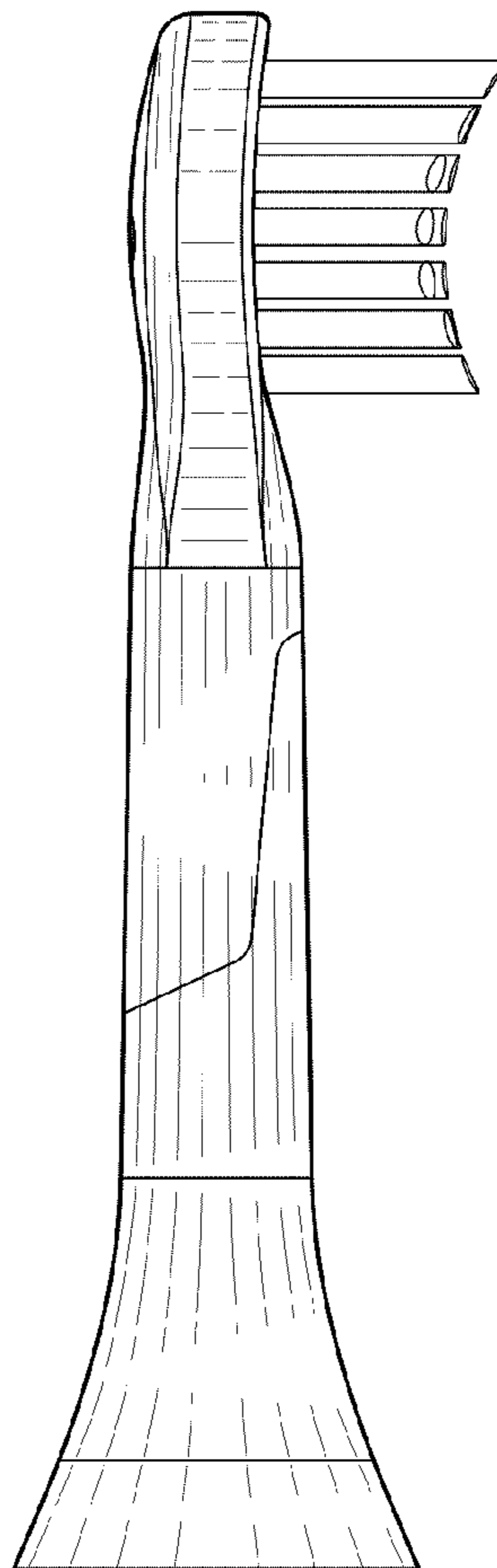
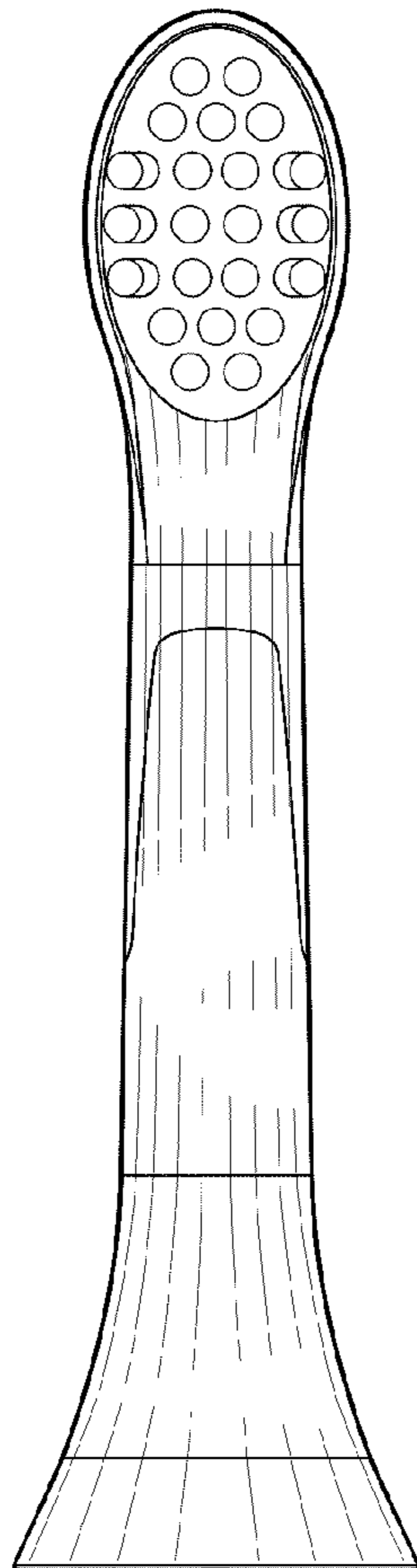

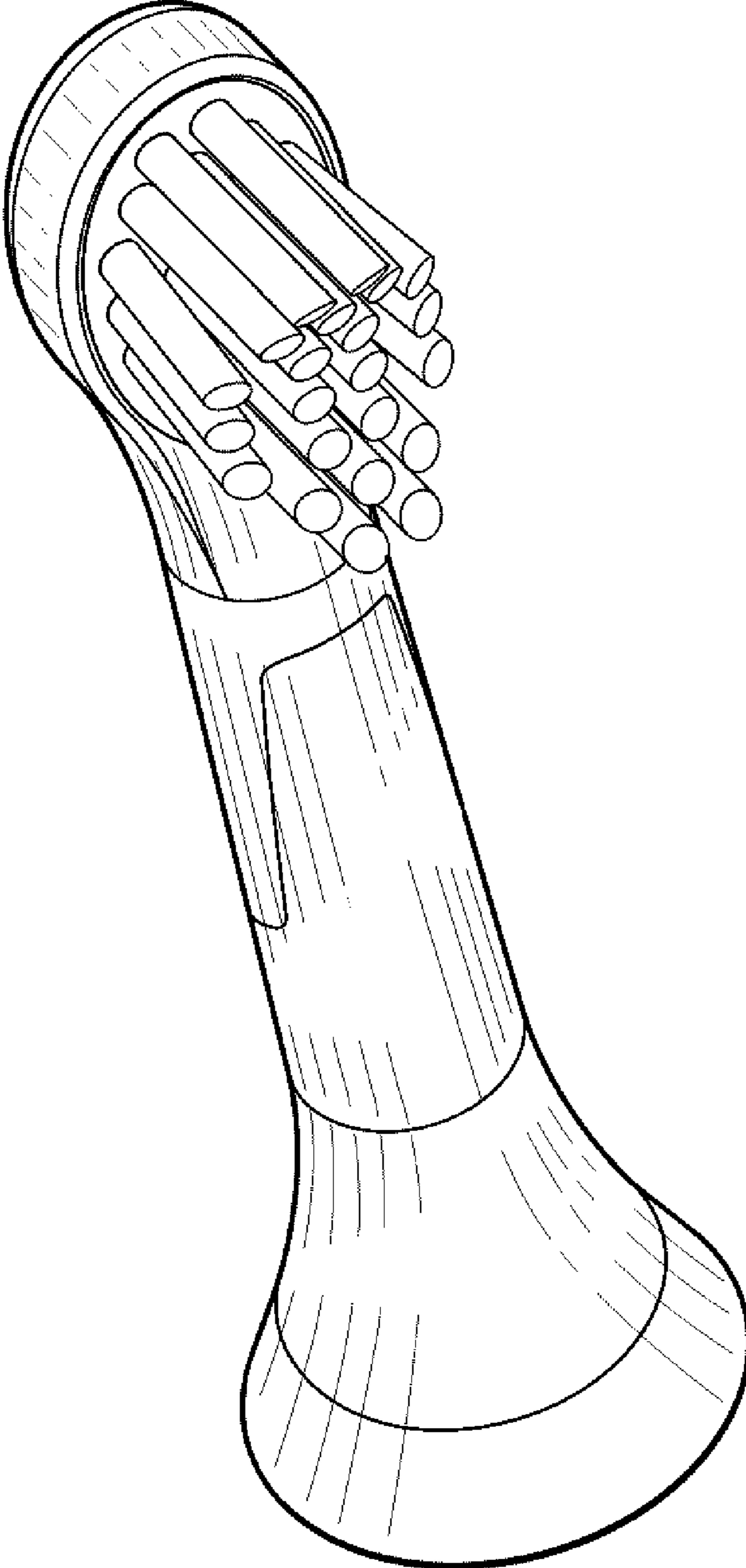

FIG. 1

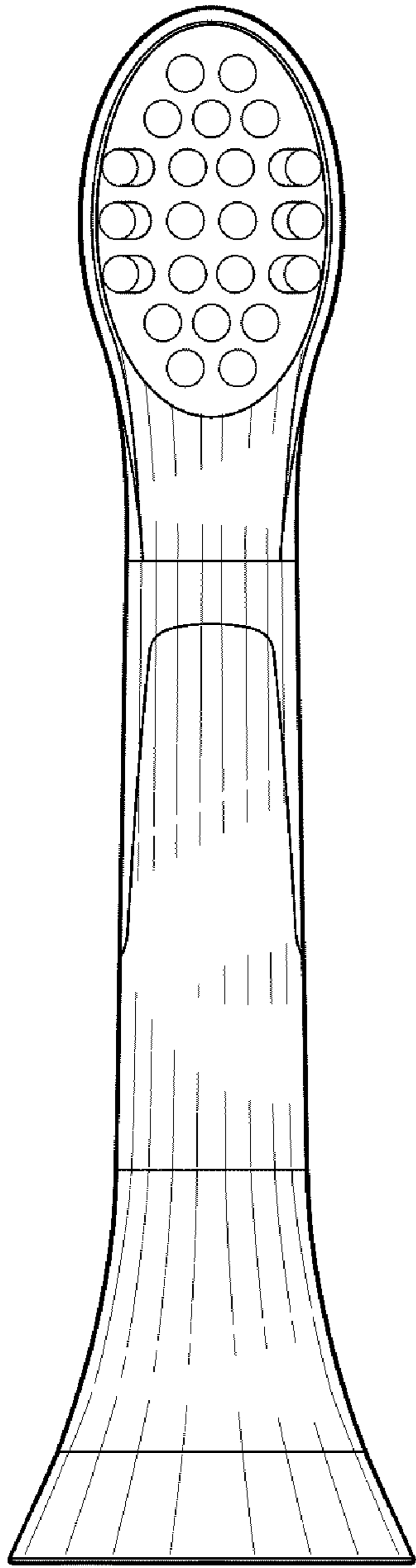

FIG. 2

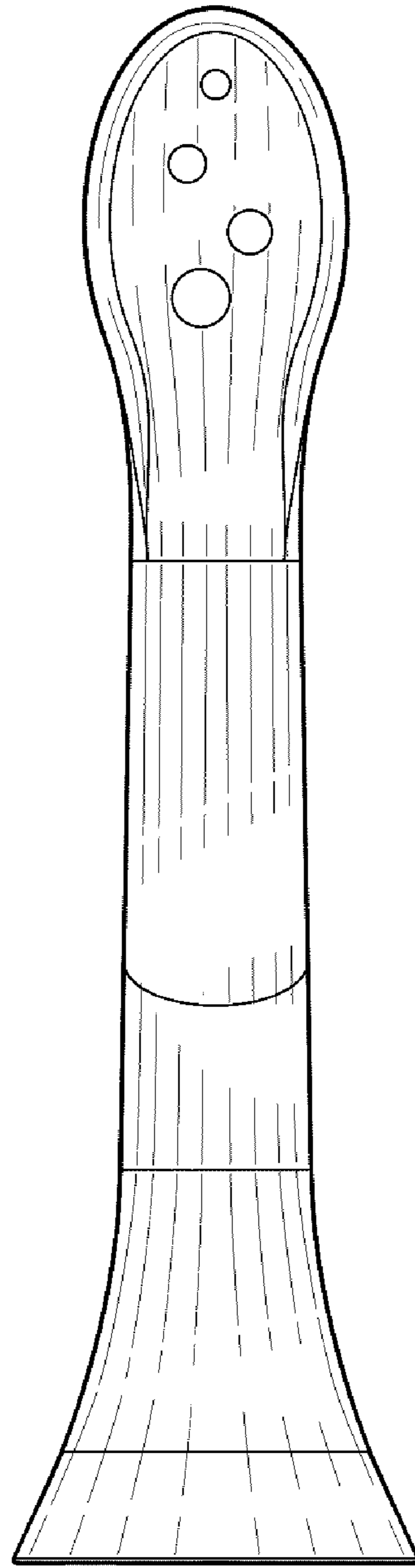

FIG. 3

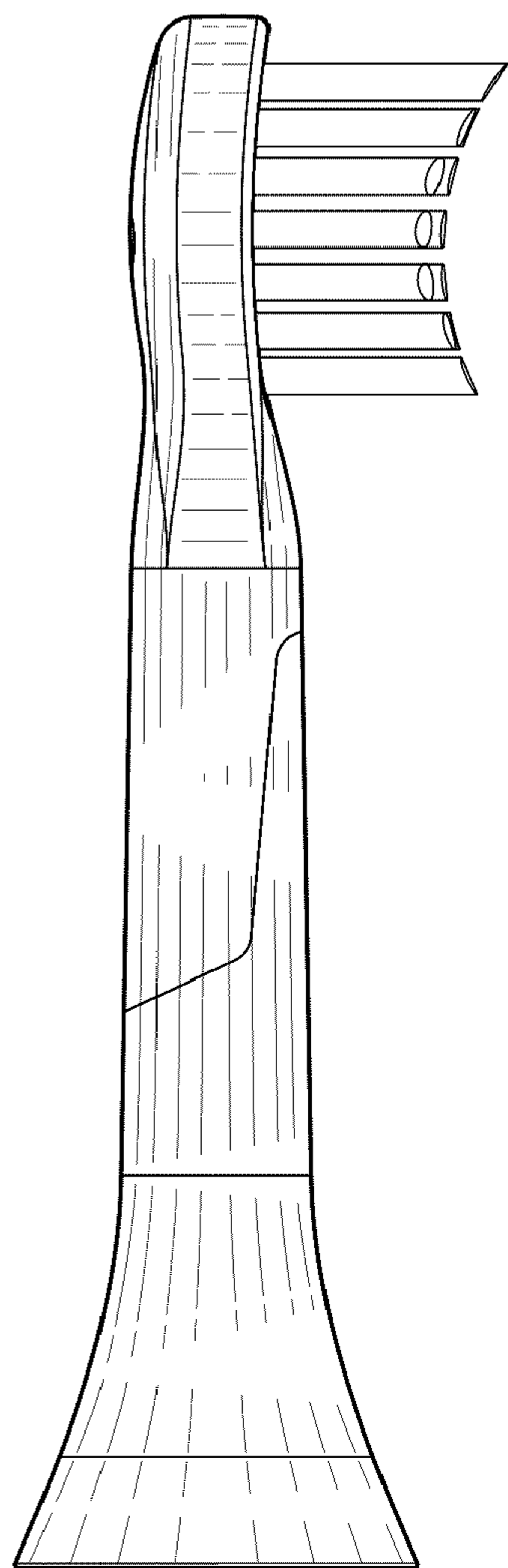

FIG. 4

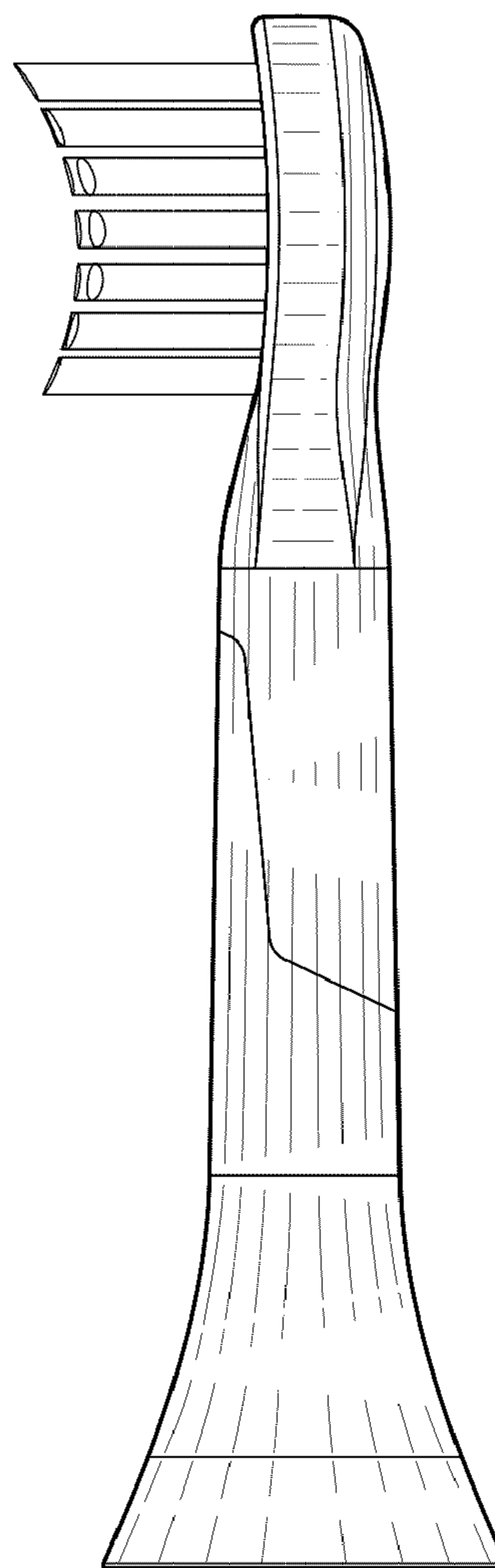

FIG. 5

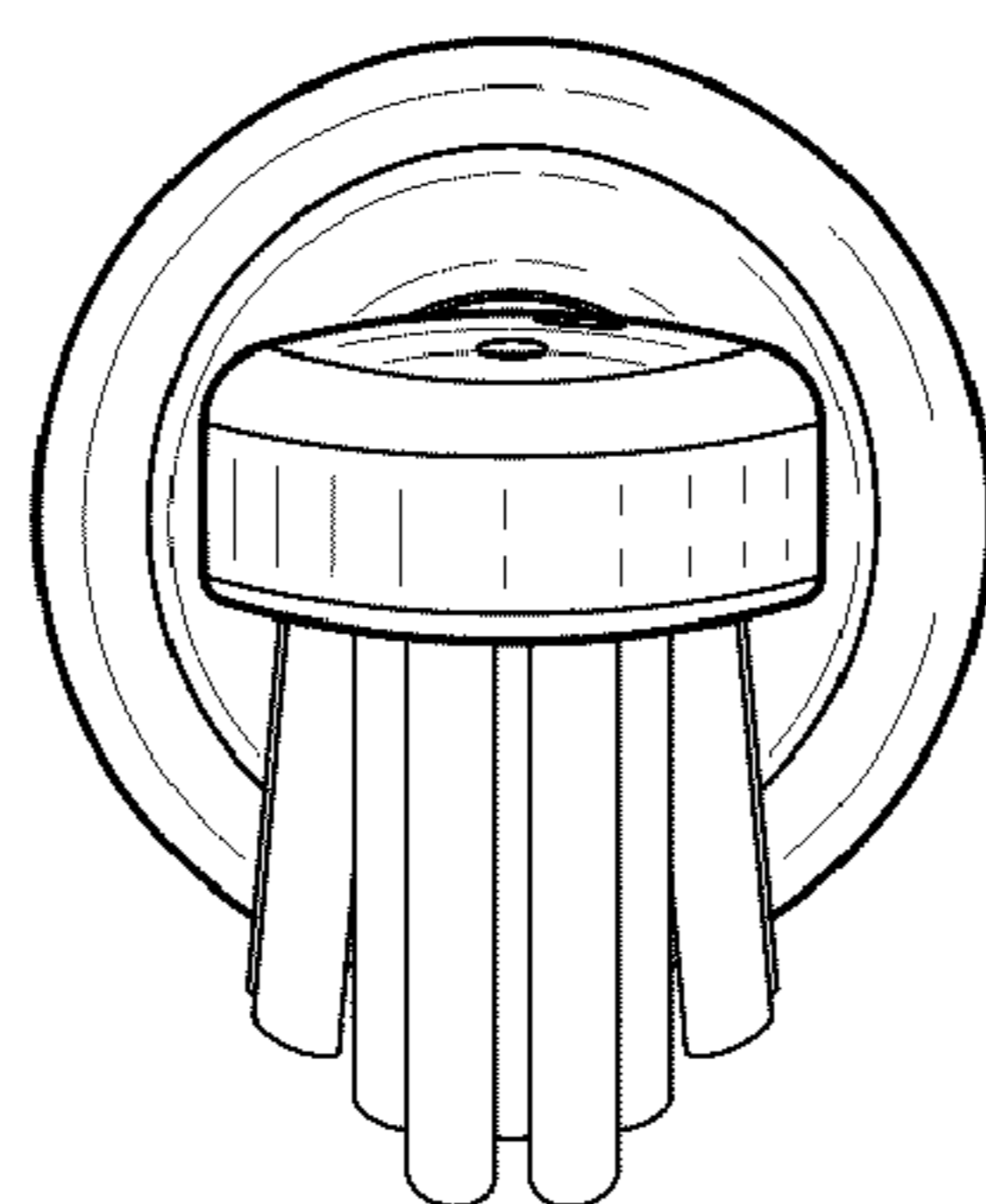

FIG. 6