



US00D652623S

(12) **United States Design Patent**
Reisenthel

(10) **Patent No.:** **US D652,623 S**
(45) **Date of Patent:** **** Jan. 24, 2012**

(54) **HANDLE BAG WITH WRAPPED FRAME**

(76) Inventor: **Peter Reisenthel**, Gilching (DE)

(**) Term: **14 Years**

(21) Appl. No.: **29/380,633**

(22) Filed: **Dec. 8, 2010**

Related U.S. Application Data

(63) Continuation-in-part of application No. 29/363,564, filed on Jun. 11, 2010, now Pat. No. Des. 631,250, which is a continuation-in-part of application No. 29/380,624, filed on Dec. 8, 2010, which is a continuation-in-part of application No. 29/380,625, filed on Dec. 8, 2010, which is a continuation-in-part of application No. 29/380,627, filed on Dec. 8, 2010, which is a continuation-in-part of application No. 29/380,628, filed on Dec. 8, 2010, which is a continuation-in-part of application No. 29/380,632, filed on Dec. 8, 2010, which is a continuation-in-part of application No. 29/380,629, filed on Dec. 8, 2010, which is a continuation-in-part of application No. 29/380,631, filed on Dec. 8, 2010.

(30) **Foreign Application Priority Data**

May 25, 2010 (EM) 001711557
Oct. 20, 2010 (EM) 001770983

(51) **LOC (9) Cl.** **03-01**

(52) **U.S. Cl.** **D3/245**

(58) **Field of Classification Search** D3/232-233,
D3/240-245; 150/100, 103-110, 113-114,
150/118-119

See application file for complete search history.

(56) **References Cited**

U.S. PATENT DOCUMENTS

D359,166	S	*	6/1995	Ford	D3/243
D549,960	S	*	9/2007	Gonzalez	D3/246
D580,165	S	*	11/2008	Pavlou	D3/245
D605,402	S	*	12/2009	Gonzalez	D3/245
D613,942	S	*	4/2010	Shing	D3/232

* cited by examiner

Primary Examiner — Holly Baynham

(74) *Attorney, Agent, or Firm* — Mayback & Hoffman, P.A.;
Gregory L. Mayback; Rebecca A. Tie

(57) **CLAIM**

The ornamental design for a handle bag with wrapped frame, as shown and described.

DESCRIPTION

FIG. 1 is a perspective view from a side corner of a handle bag with wrapped frame according to the present invention, the tag indicated with dashed lines is for illustrative purposes only and forms no part of the claimed design;

FIG. 2 is an elevational view of a first side of the handle bag with wrapped frame of FIG. 1, the tag indicated with dashed lines is for illustrative purposes only and forms no part of the claimed design;

FIG. 3 is an elevational view of a second side of the handle bag with wrapped frame of FIG. 1 from a side opposite the view of FIG. 2;

FIG. 4 is an elevational view of a third side of the handle bag with wrapped frame of FIG. 1;

FIG. 5 is an elevational view of a fourth side of the handle bag with wrapped frame of FIG. 1 from a side opposite the view of FIG. 4, the tag indicated with dashed lines is for illustrative purposes only and forms no part of the claimed design;

FIG. 6 is a top plan view of the handle bag with wrapped frame of FIG. 1, the tag indicated with dashed lines is for illustrative purposes only and forms no part of the claimed design; and,

FIG. 7 is a bottom plan view of the handle bag with wrapped frame of FIG. 1.

1 Claim, 3 Drawing Sheets

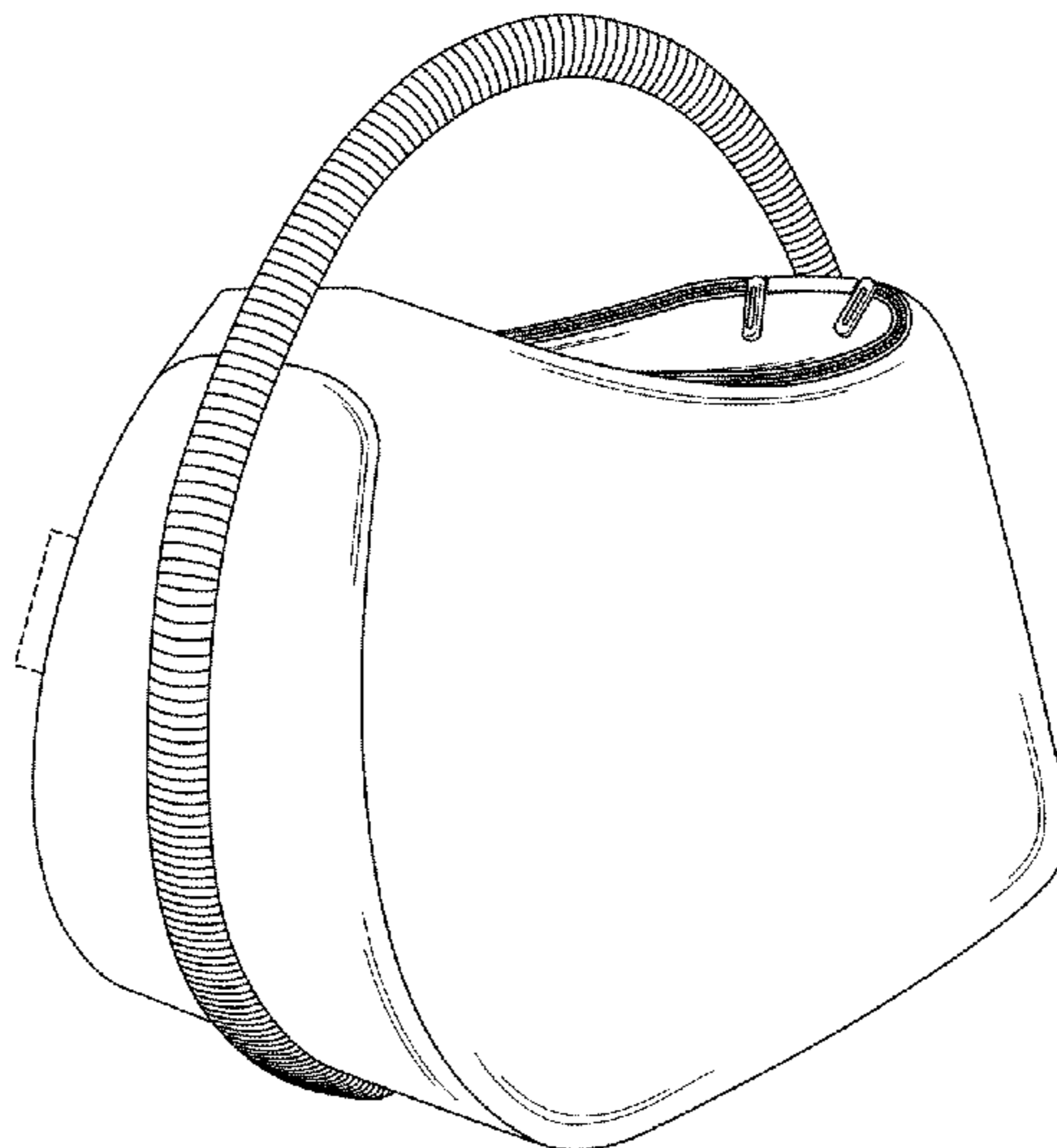

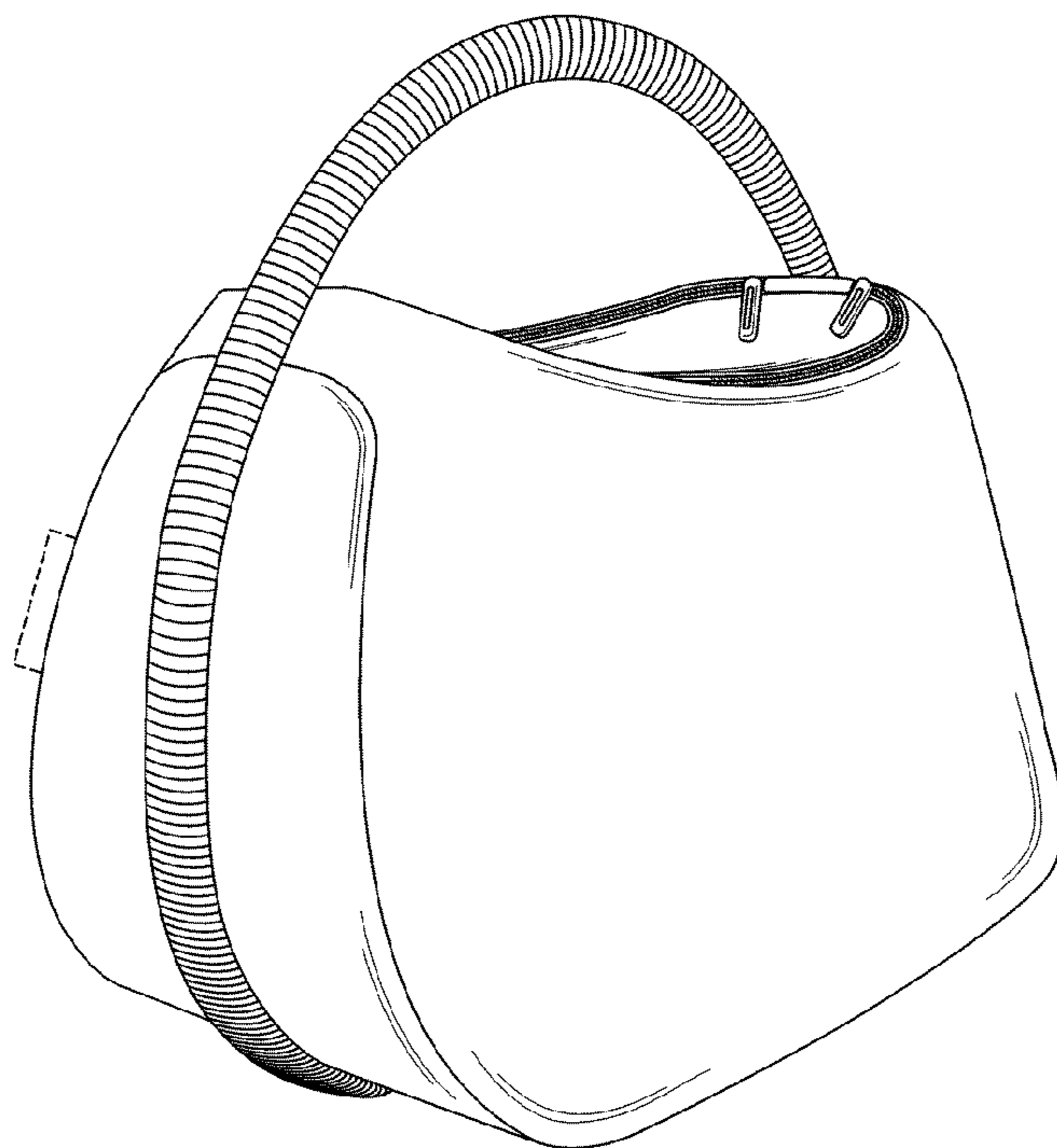

FIG. 1

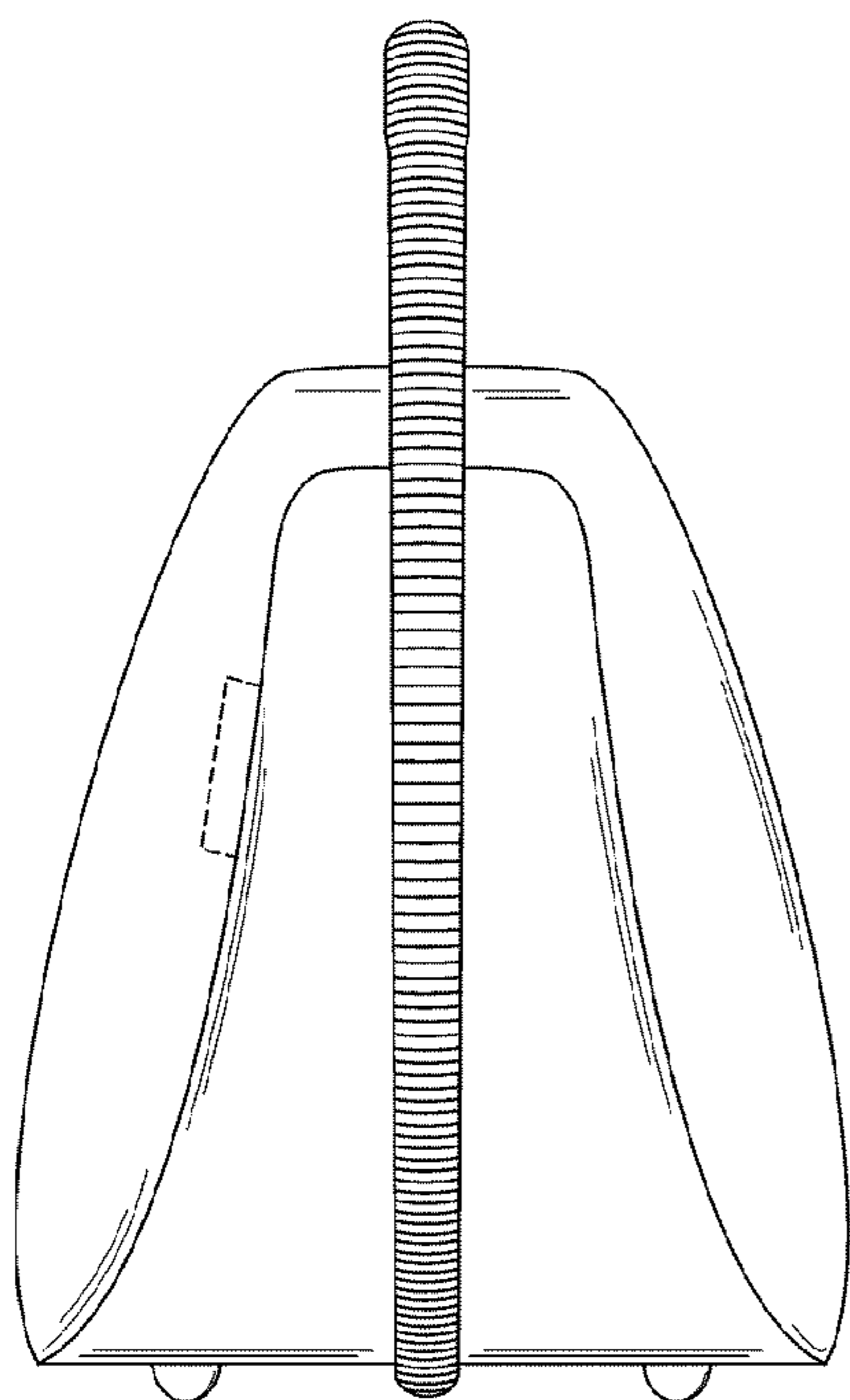

FIG. 2

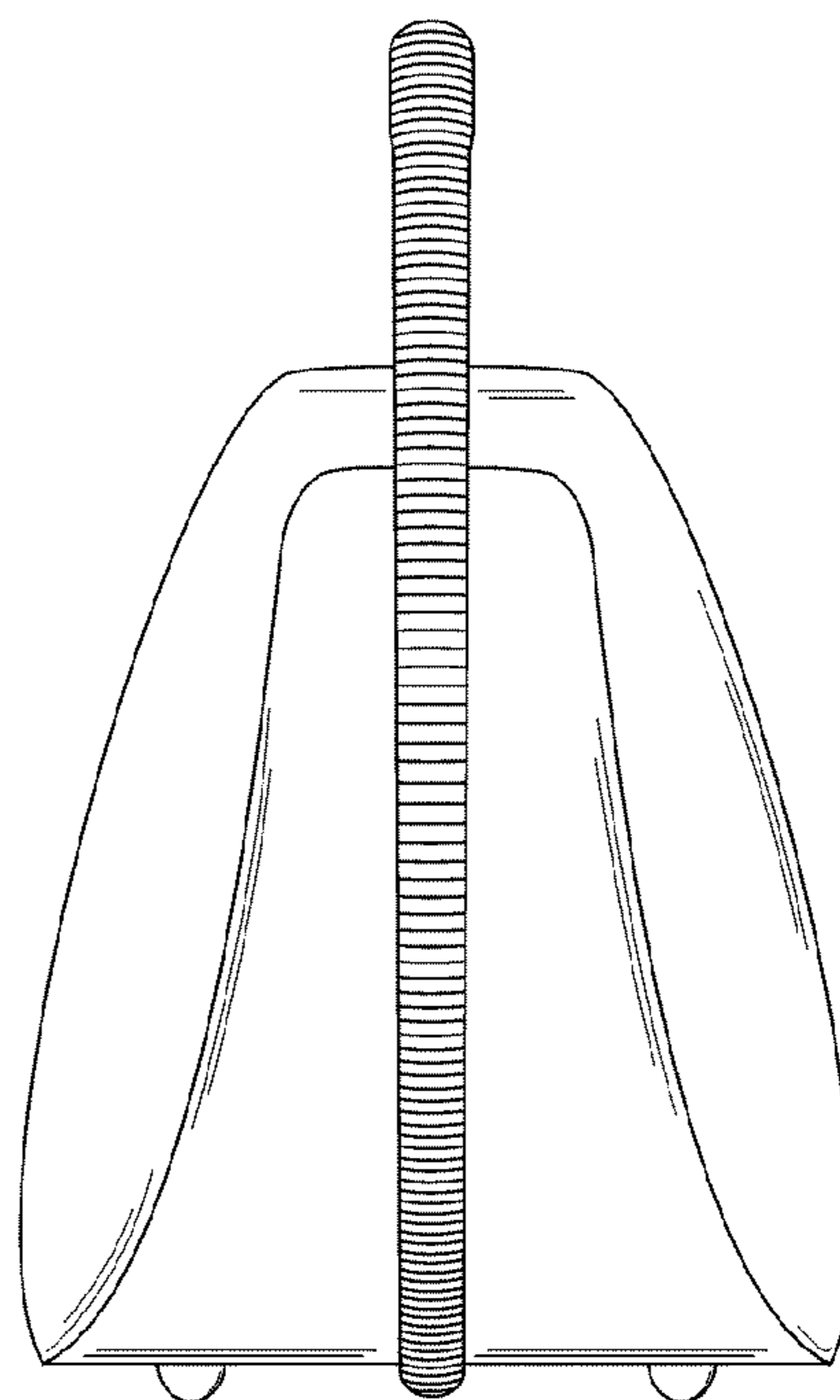

FIG. 3

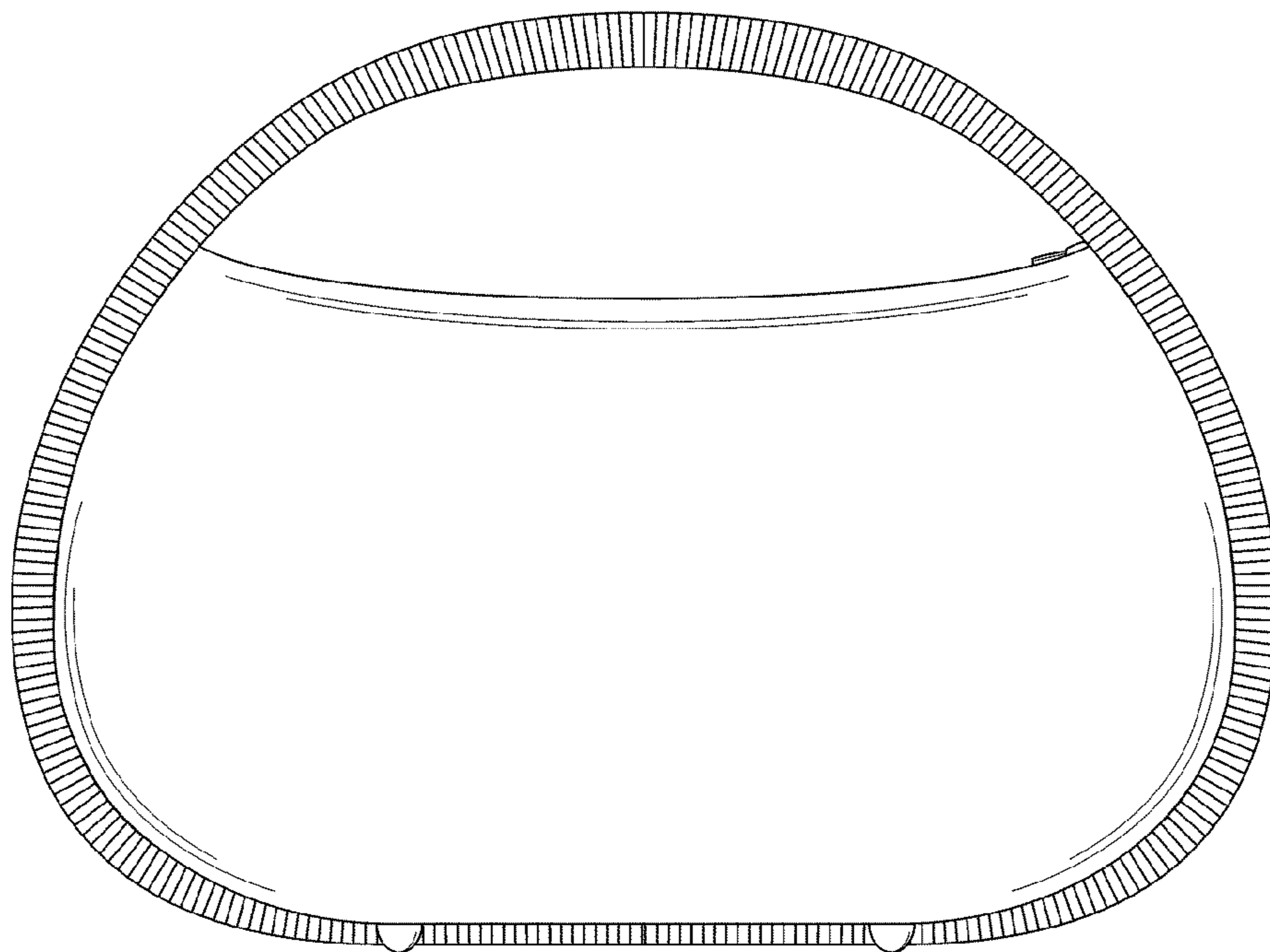

FIG. 4

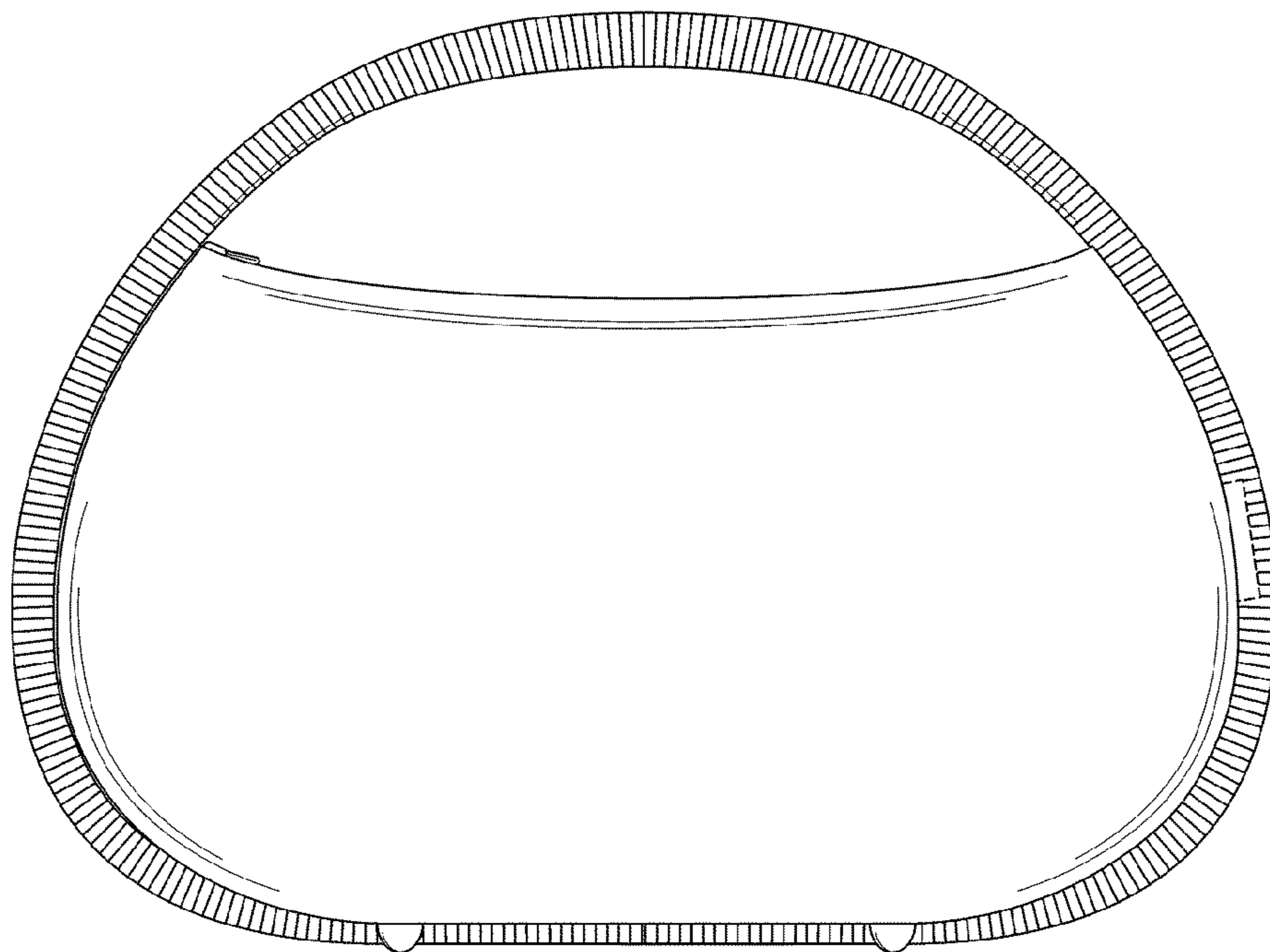

FIG. 5

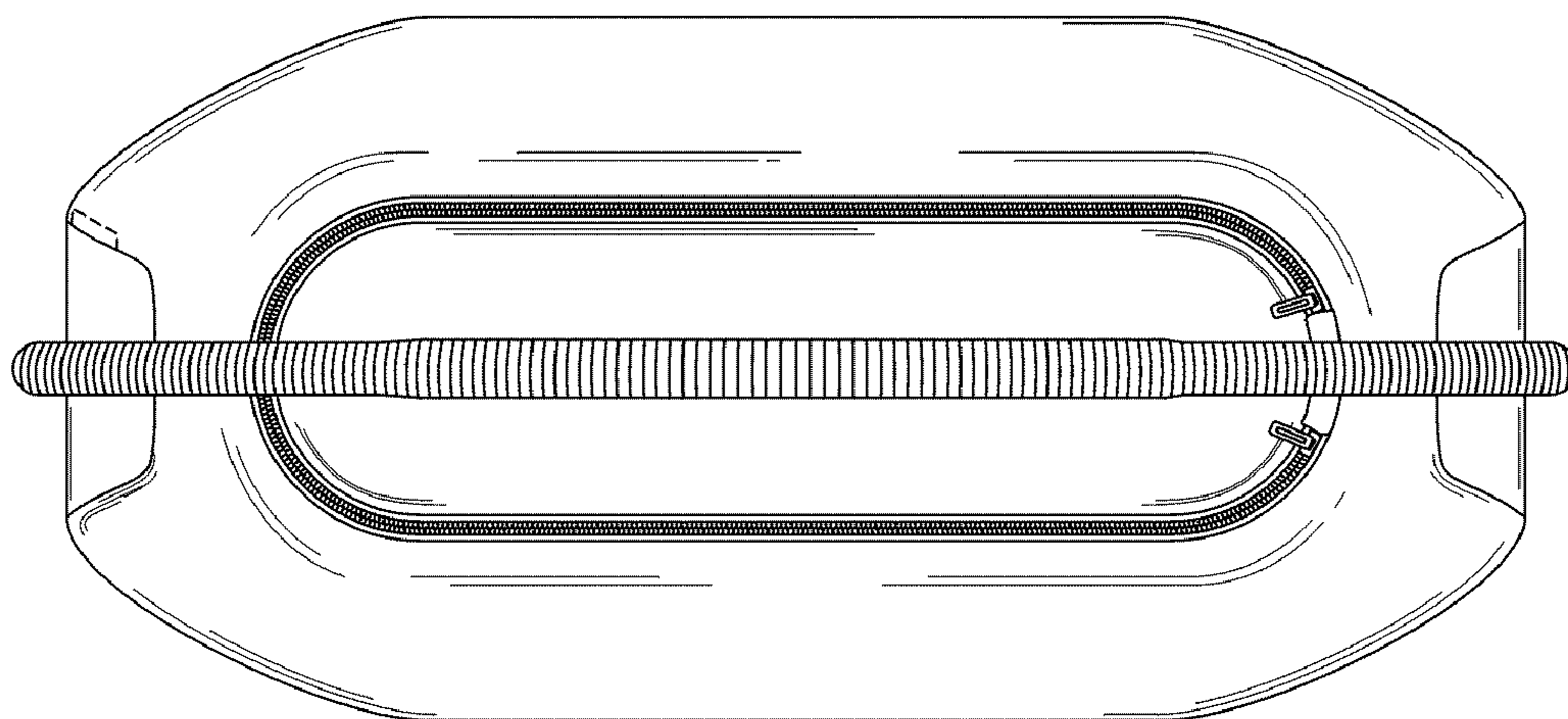

FIG. 6

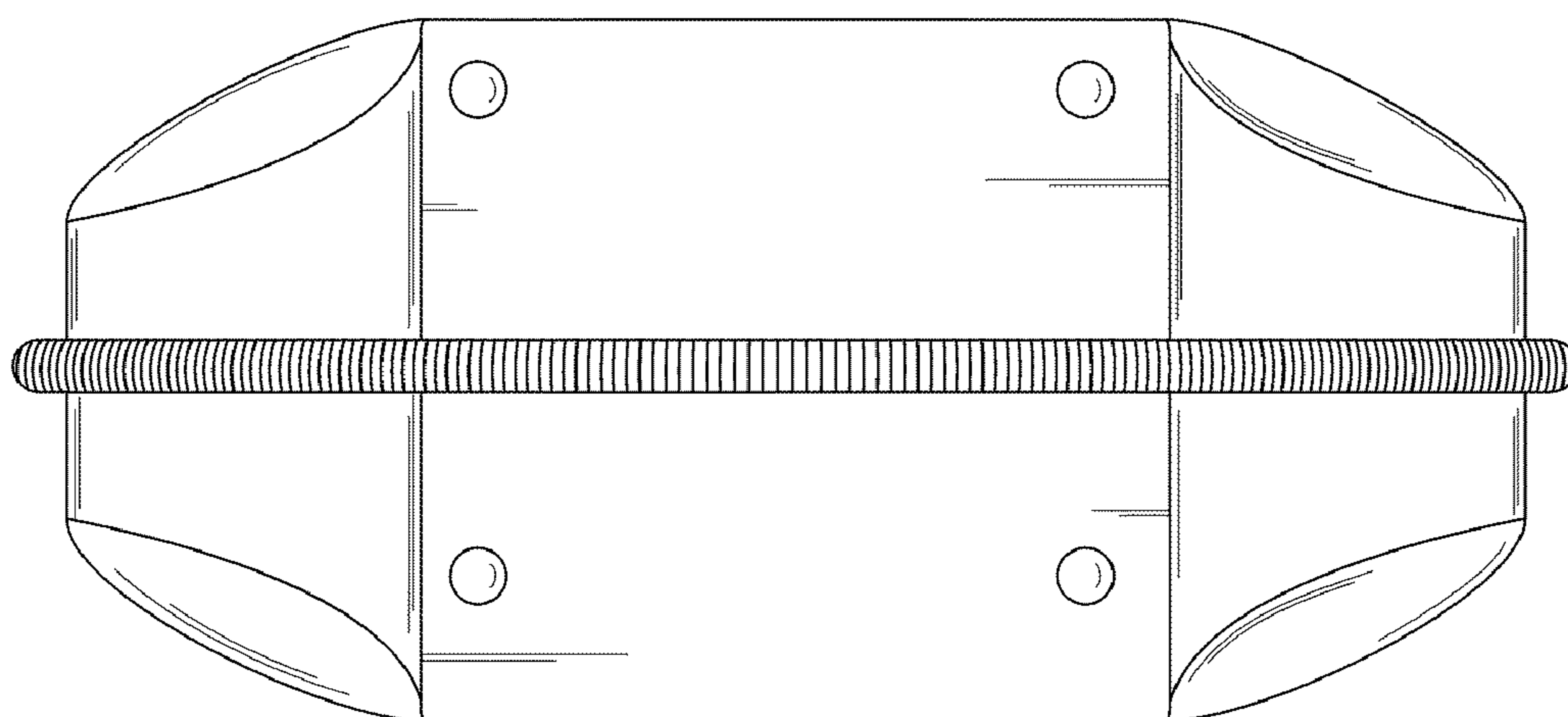

FIG. 7