



US00D652599S

(12) **United States Design Patent**
Kane

(10) **Patent No.:** **US D652,599 S**

(45) **Date of Patent:** **** Jan. 17, 2012**

(54) **RECYCLING RECEPTACLE**

(75) Inventor: **Brian Kane**, San Francisco, CA (US)

(73) Assignee: **Landscape Forms, Inc.**, Kalamazoo, MI (US)

(**) Term: **14 Years**

(21) Appl. No.: **29/394,644**

(22) Filed: **Jun. 20, 2011**

(51) **LOC (9) Cl.** **09-09**

(52) **U.S. Cl.** **D34/1**

(58) **Field of Classification Search** D34/1,
D34/5, 6, 7, 8, 9, 10, 11; 220/908, 908.1,
220/909

See application file for complete search history.

(56) **References Cited**

U.S. PATENT DOCUMENTS

5,377,907	A *	1/1995	Guard	232/43.2
D535,447	S *	1/2007	Olivetti	D34/1
D613,019	S *	3/2010	Moore	D34/7
D629,992	S *	12/2010	Wolff	D34/7
D640,027	S *	6/2011	Strempack et al.	D34/1
8,042,703	B2 *	10/2011	Dembowiak	220/495.08

OTHER PUBLICATIONS

“Transit Litter & Recycling Receptacle”, <http://www.forms-surfaces.com>, May 12, 2011, 1 pg.

“Rubbermaid Silhouettes Designer Rectangular Waste Receptacle”, <http://www.webstaurantstore.com>, May 12, 2011, 1 pg.

“Geocube”, <http://www.witt.com>, May 12, 2011, 1 pg.

“Indoor Recycling Unit (Millenium)”, <http://www.buschsystems.com>, May 12, 2011, 1 pg.

* cited by examiner

Primary Examiner — Cynthia Ramirez

(74) *Attorney, Agent, or Firm* — Heslin Rothenberg Farley & Mesiti P.C.

(57) **CLAIM**

The ornamental design for a recycling receptacle, as shown and described.

DESCRIPTION

FIG. 1 is a perspective view of a first embodiment of the recycling receptacle of the present invention;
 FIG. 2 is a front elevation view thereof;
 FIG. 3 is a right side elevation view thereof, the left side elevation view being a mirror image thereof;
 FIG. 4 is a rear elevation view thereof;
 FIG. 5 is a top plan view thereof;
 FIG. 6 is a bottom plan view thereof;
 FIG. 7 is a perspective view of a second embodiment;
 FIG. 8 is a front elevation view thereof;
 FIG. 9 is a right side elevation view thereof, the left side elevation being a mirror image thereof;
 FIG. 10 is a rear elevation view thereof;
 FIG. 11 is a top plan view thereof;
 FIG. 12 is a bottom plan view thereof;
 FIG. 13 is a perspective view of a third embodiment;
 FIG. 14 is a front elevation view thereof;
 FIG. 15 is a right side elevation view thereof, the left side elevation view being a mirror image thereof;
 FIG. 16 is a rear elevation view thereof;
 FIG. 17 is a top plan view thereof;
 FIG. 18 is a bottom plan view thereof;
 FIG. 19 is a perspective view of a fourth embodiment;
 FIG. 20 is a front elevation view thereof;
 FIG. 21 is a right side elevation view thereof, the left side elevation view being a mirror image of FIG. 3;
 FIG. 22 is a rear elevation view thereof;
 FIG. 23 is a top plan view thereof;
 FIG. 24 is a bottom plan view thereof;
 FIG. 25 is a perspective view of a fifth embodiment;
 FIG. 26 is a front elevation view thereof;
 FIG. 27 is a right side elevation view thereof, the left side elevation view being a mirror image of FIG. 3;
 FIG. 28 is a rear elevation view thereof;
 FIG. 29 is a top plan view thereof; and,
 FIG. 30 is a bottom plan view thereof.

1 Claim, 30 Drawing Sheets

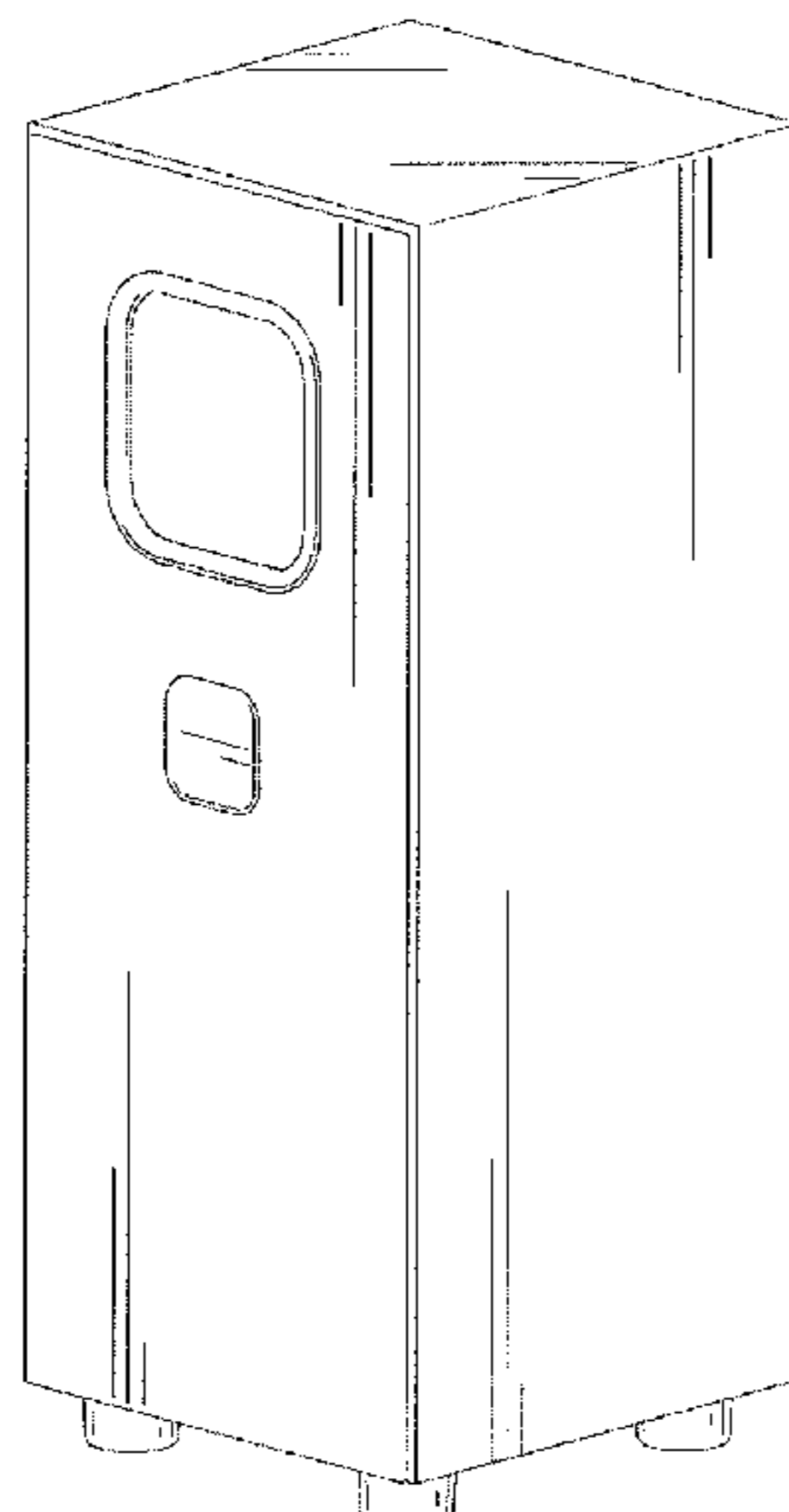

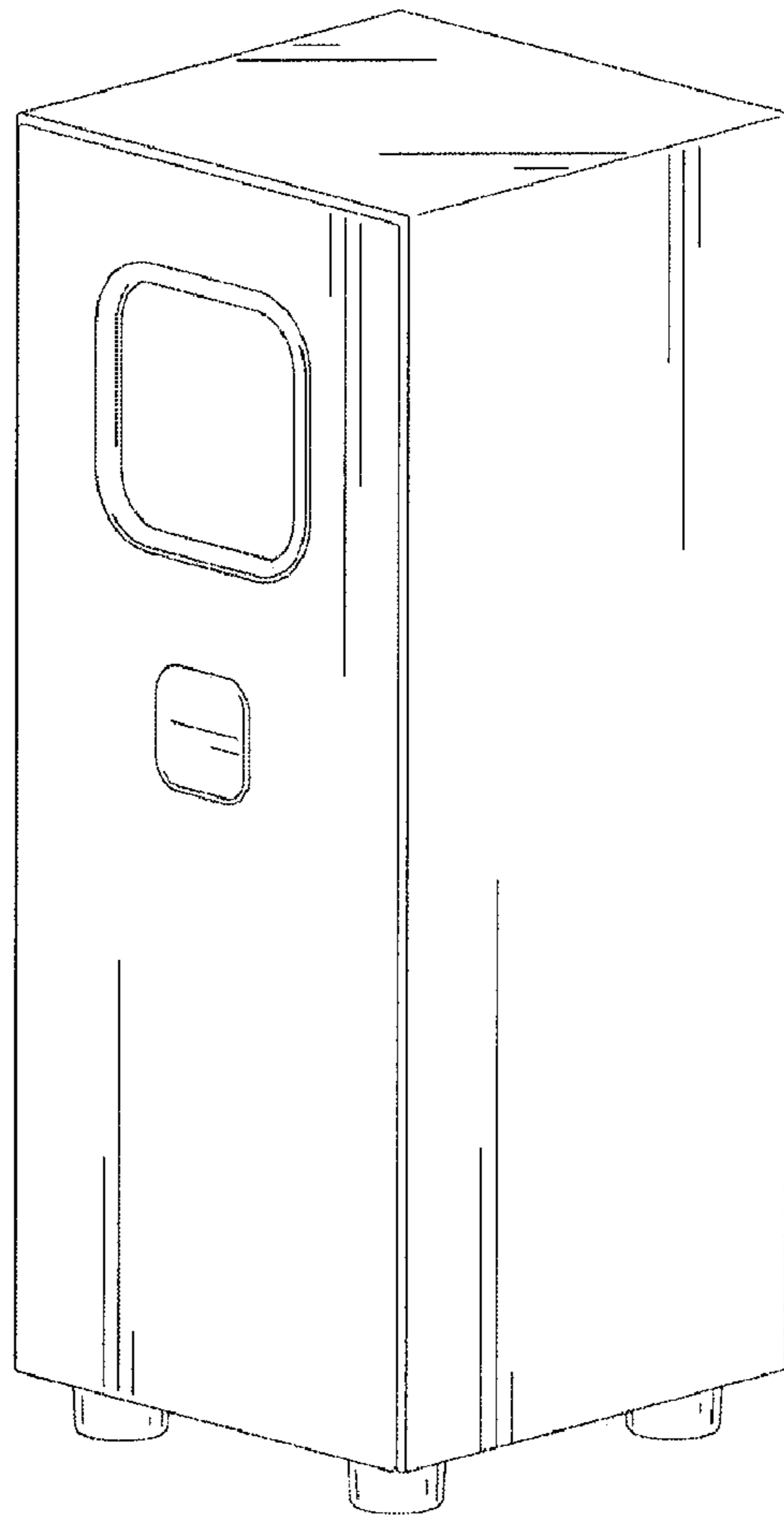

FIG. 1

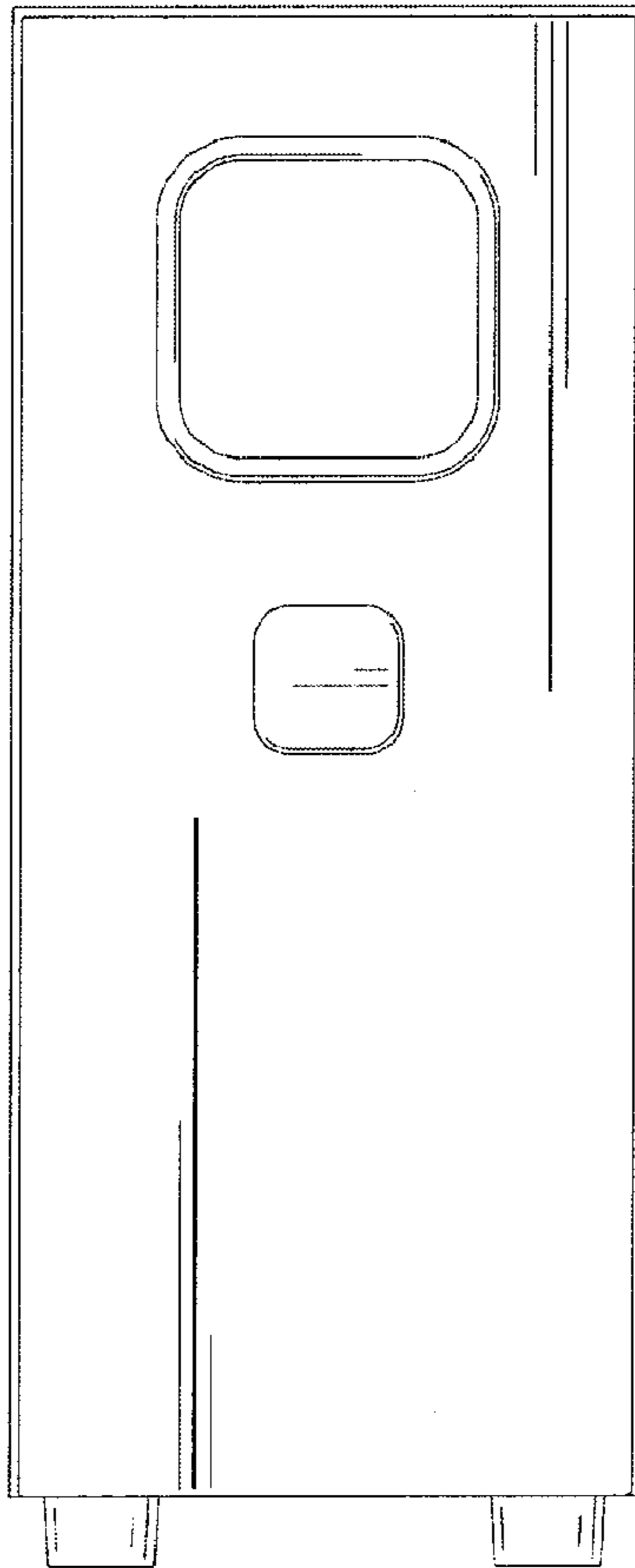

FIG. 2

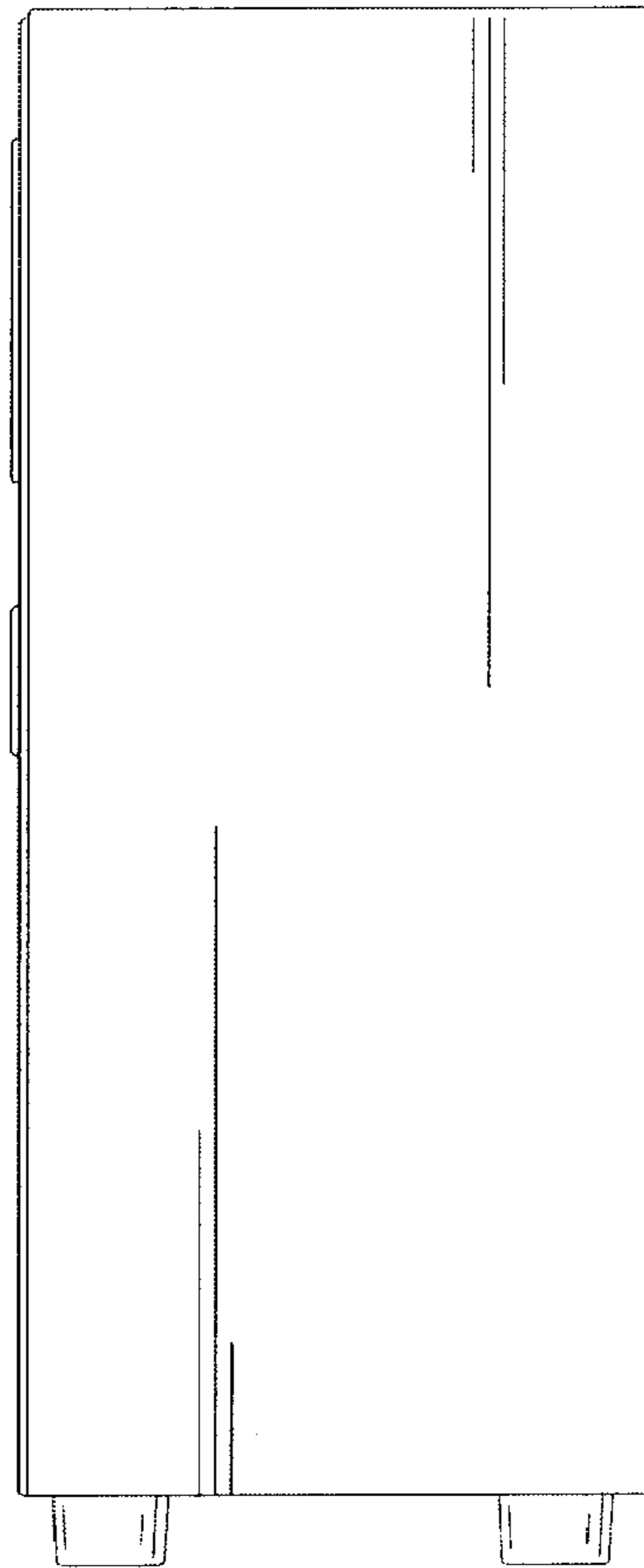

FIG. 3

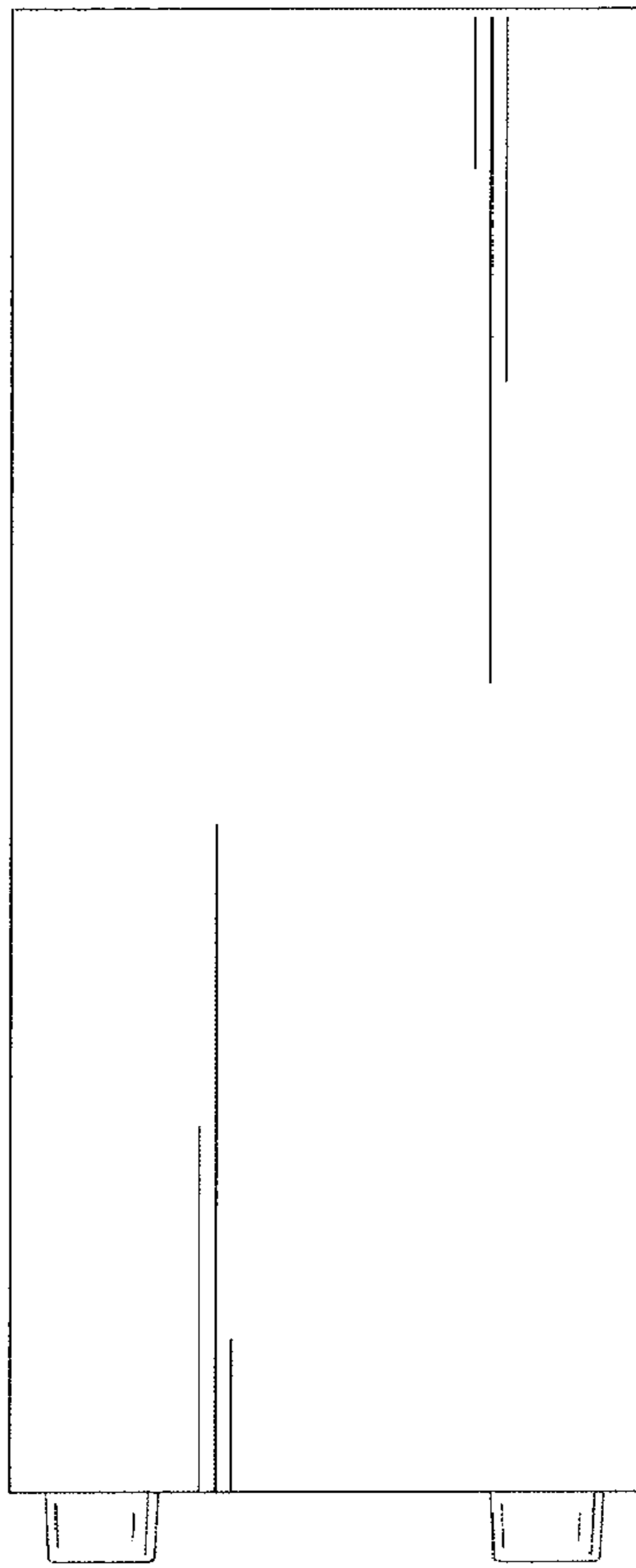

FIG. 4

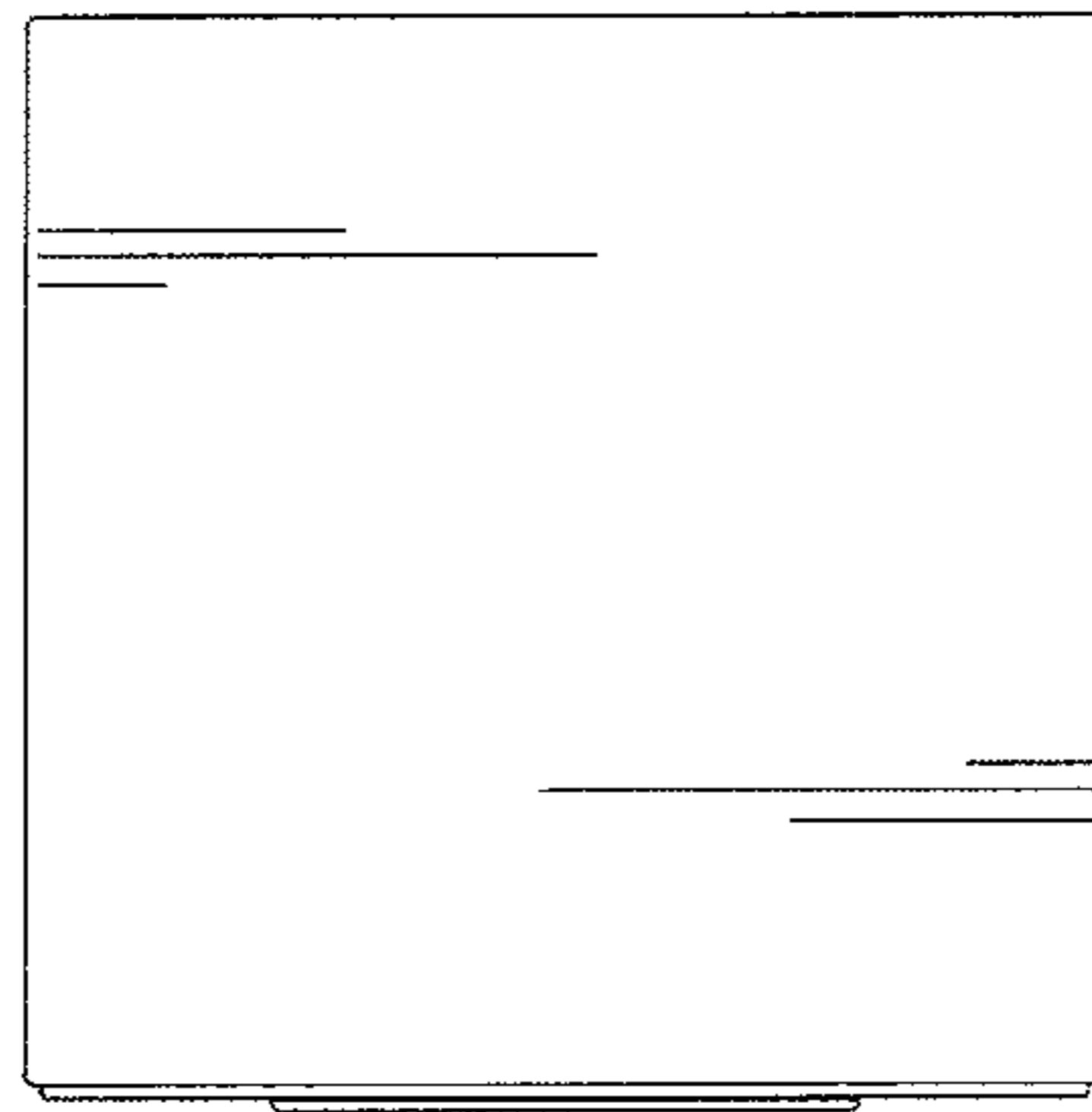

FIG. 5

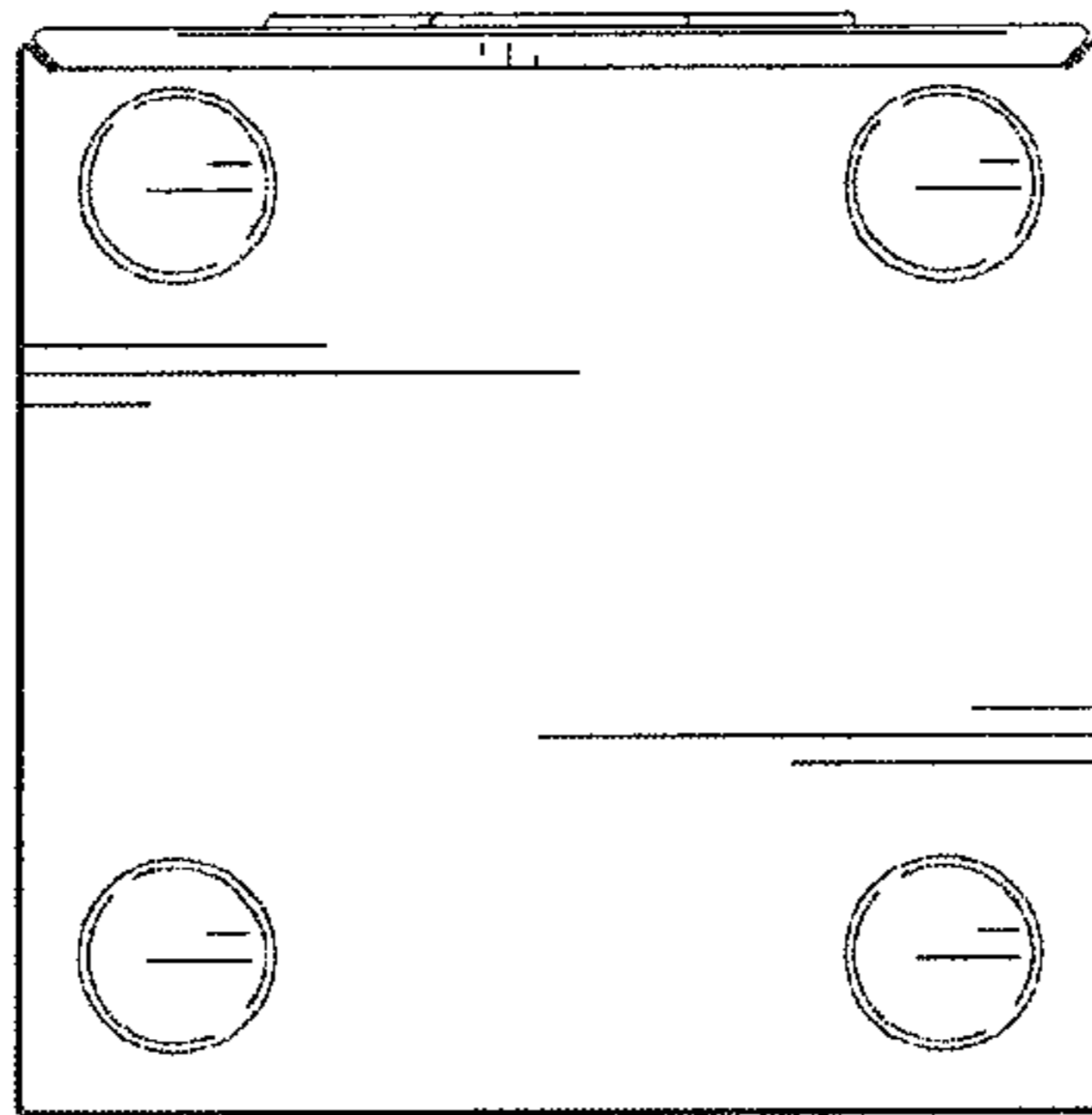

FIG. 6

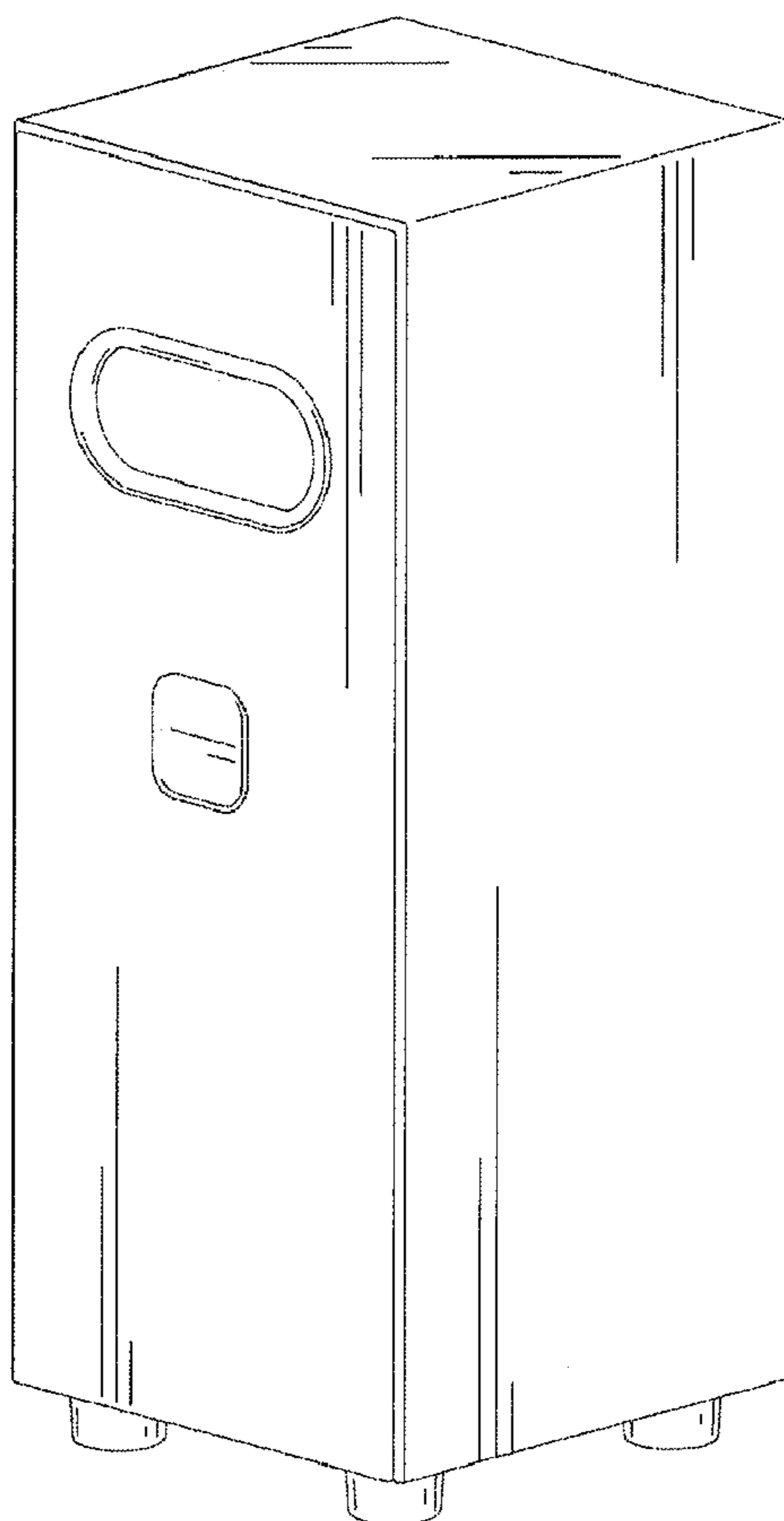

FIG. 7

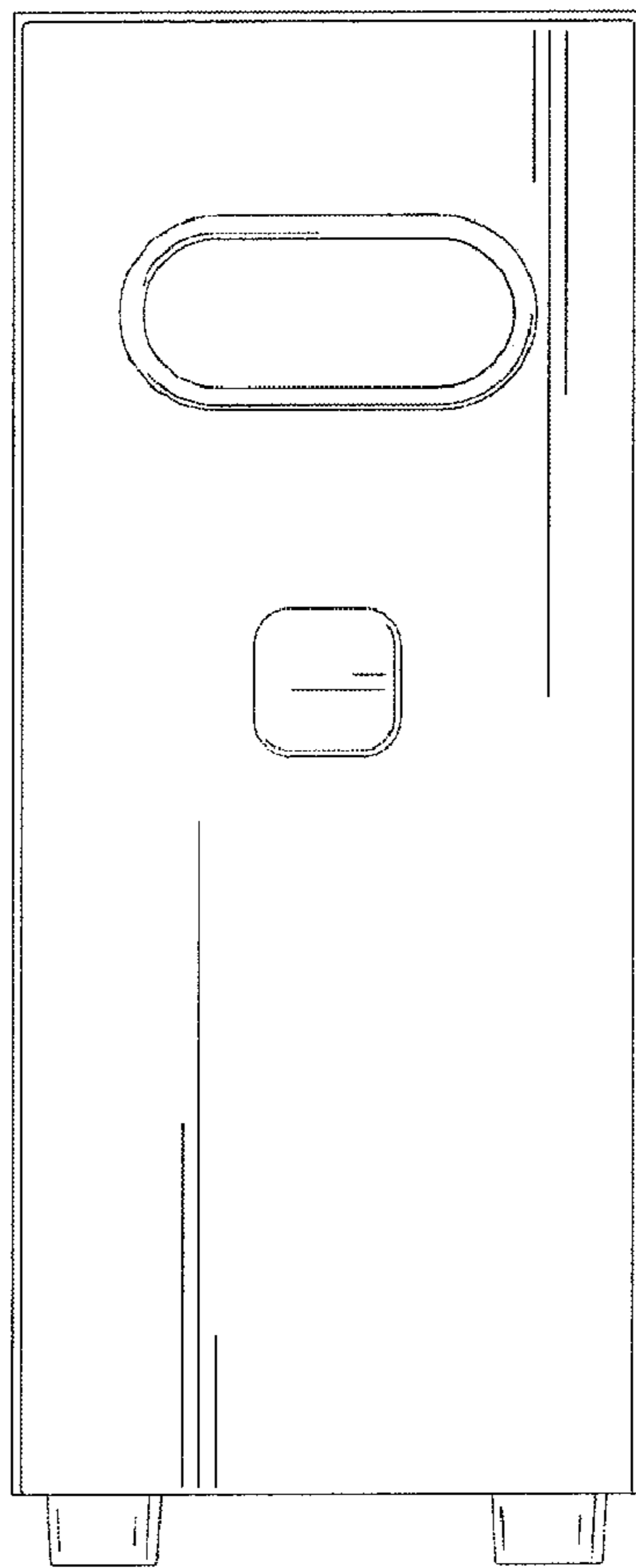

FIG. 8

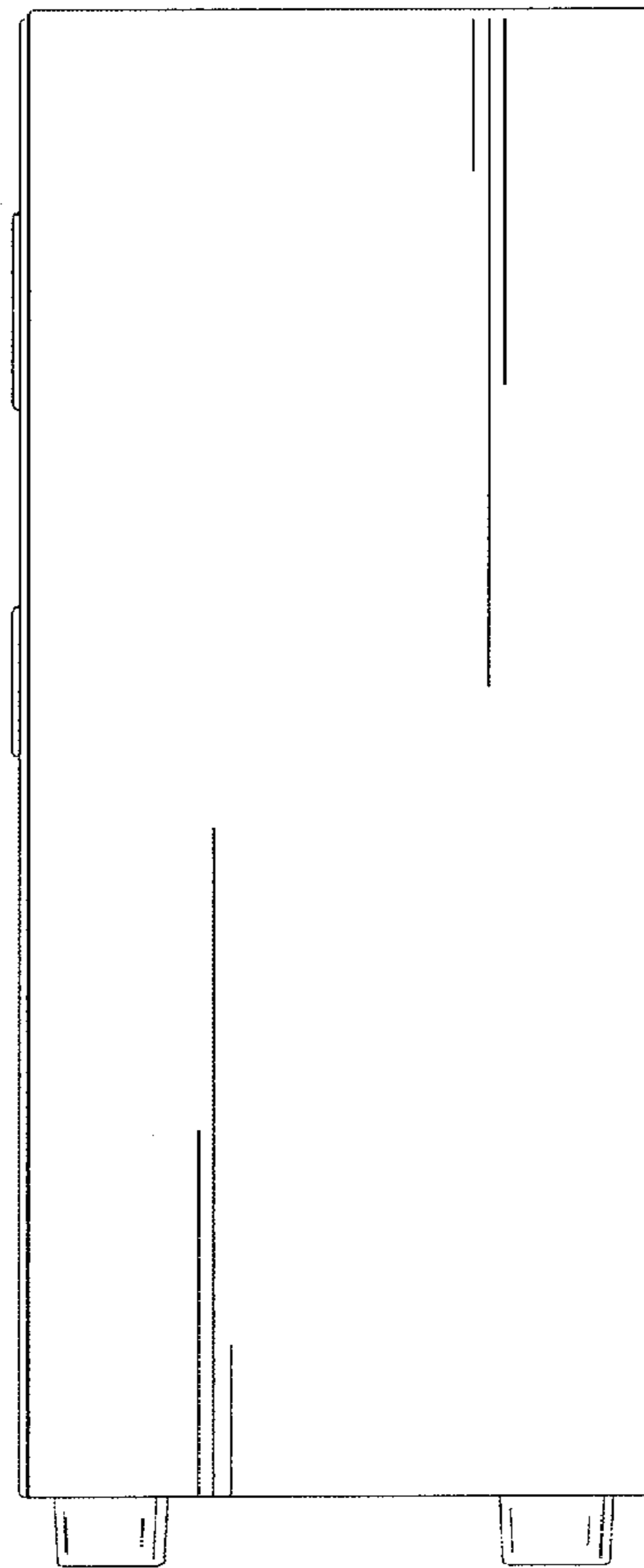

FIG. 9

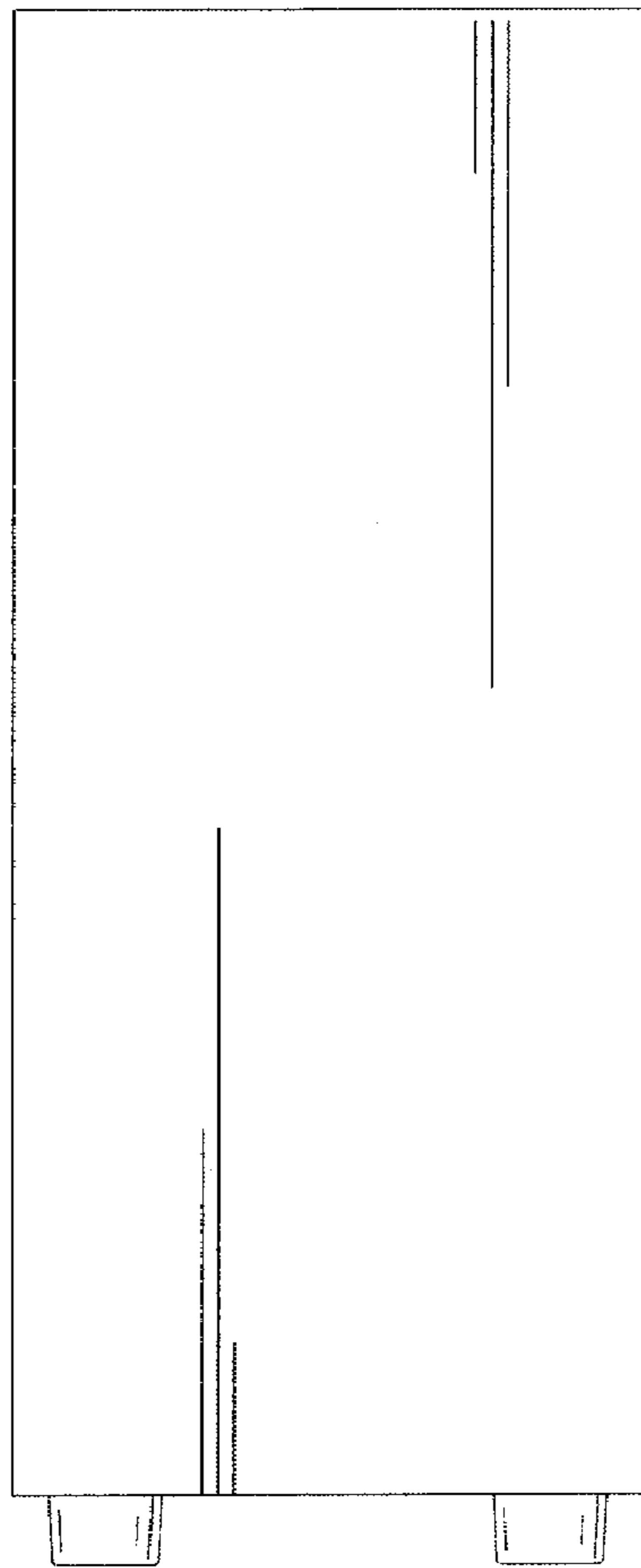

FIG. 10

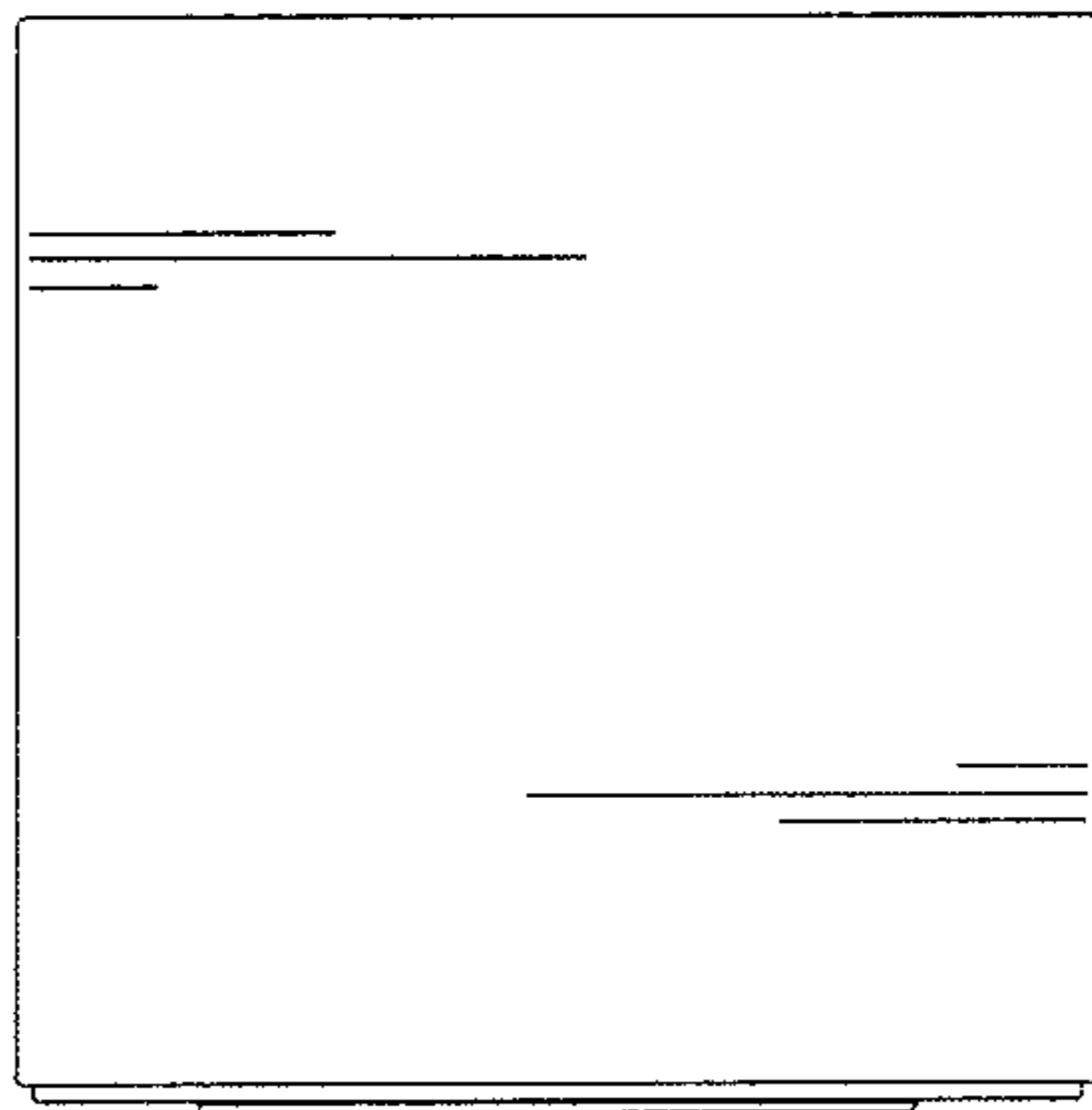

FIG. 11

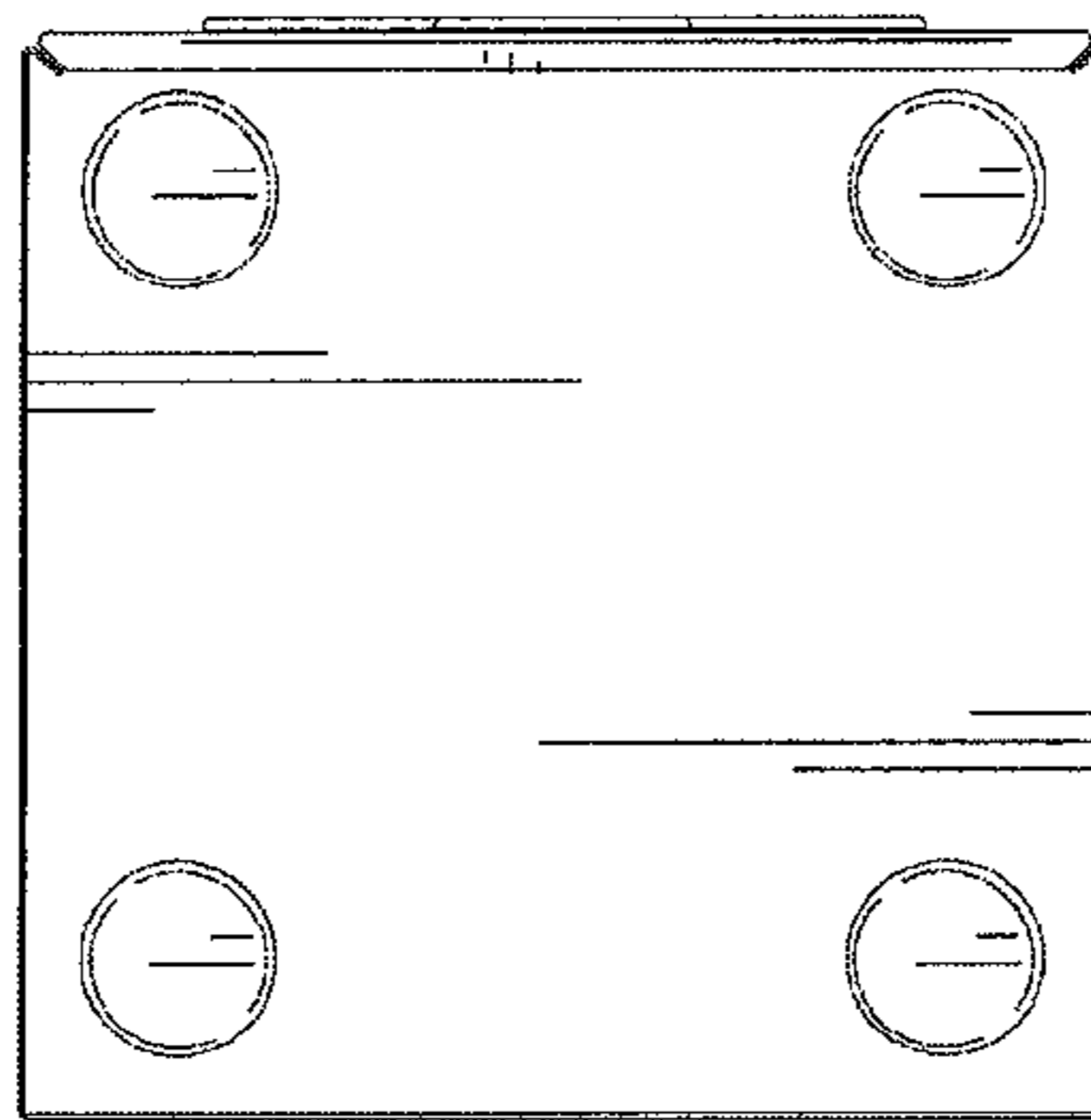

FIG. 12

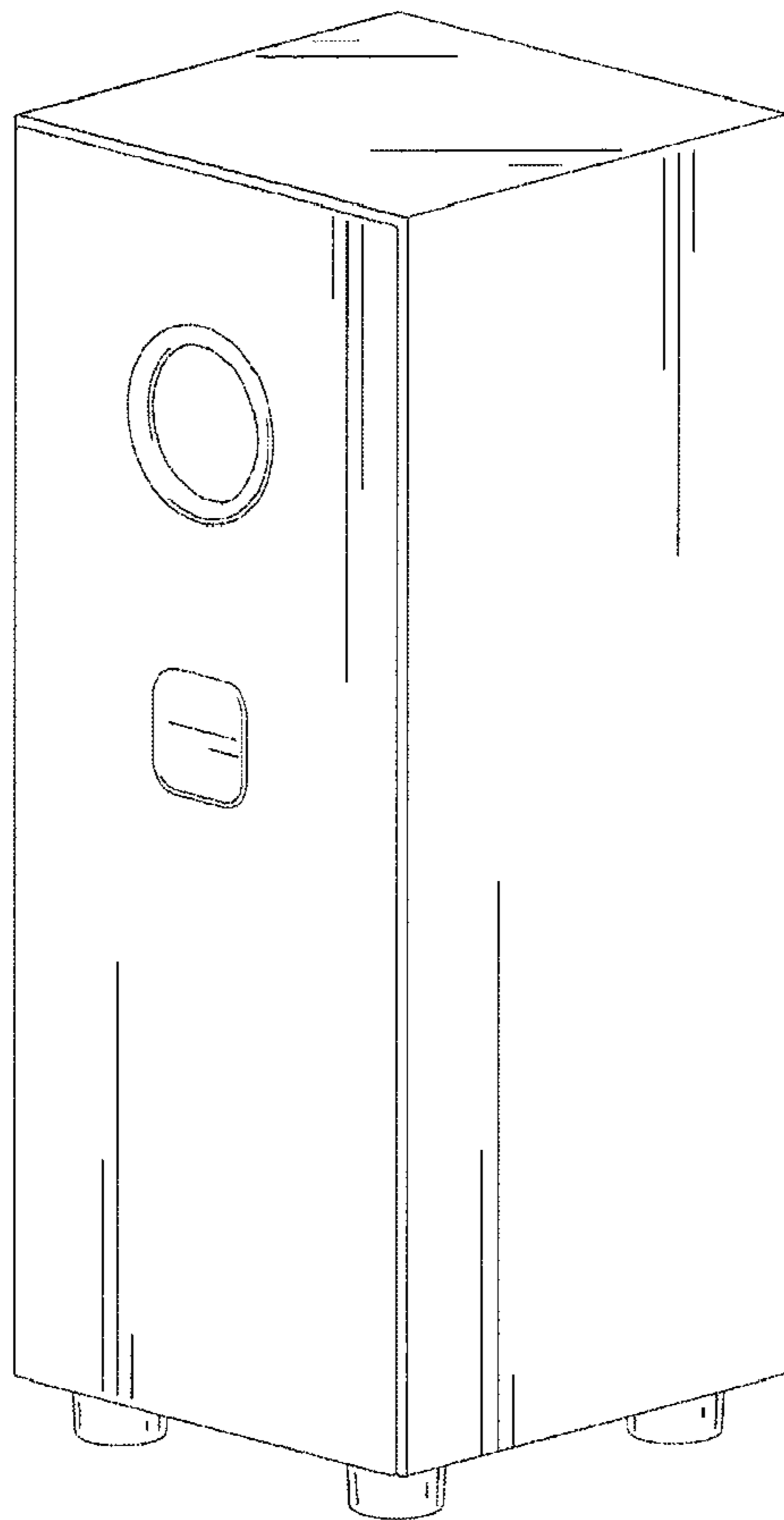

FIG. 13

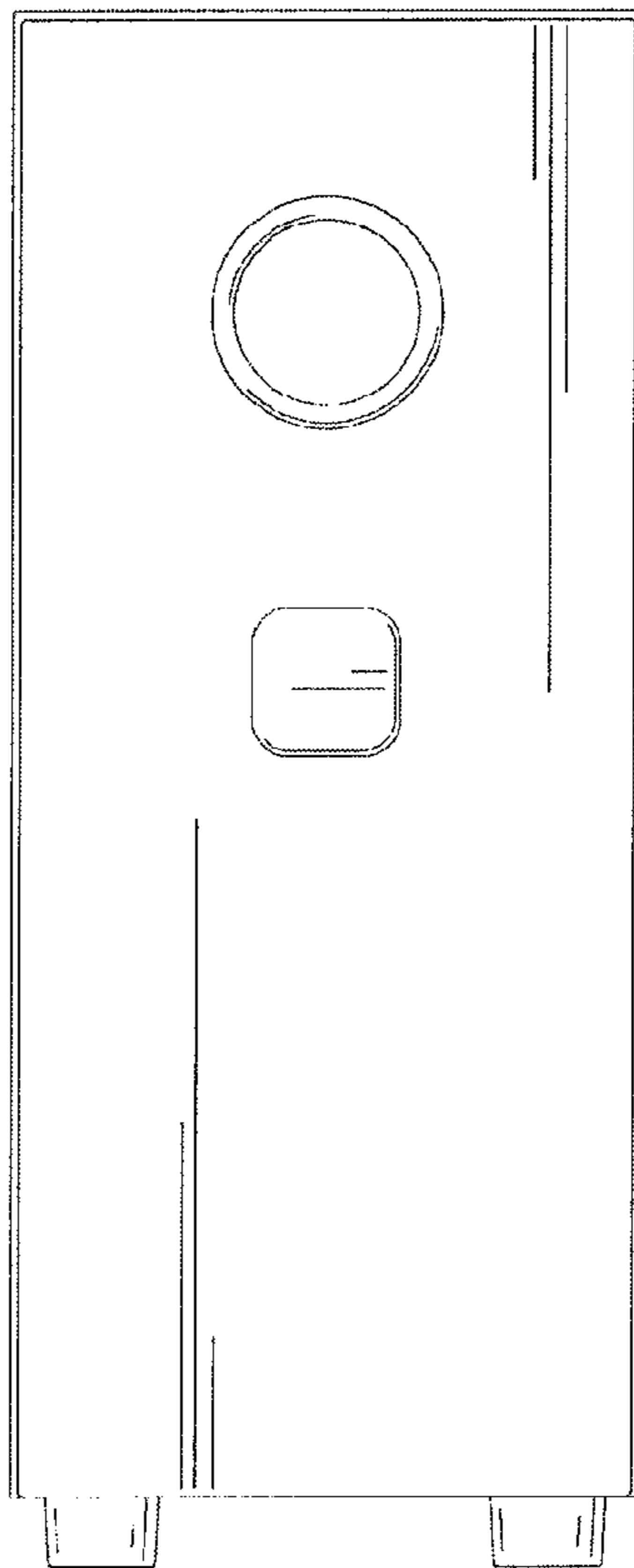

FIG. 14

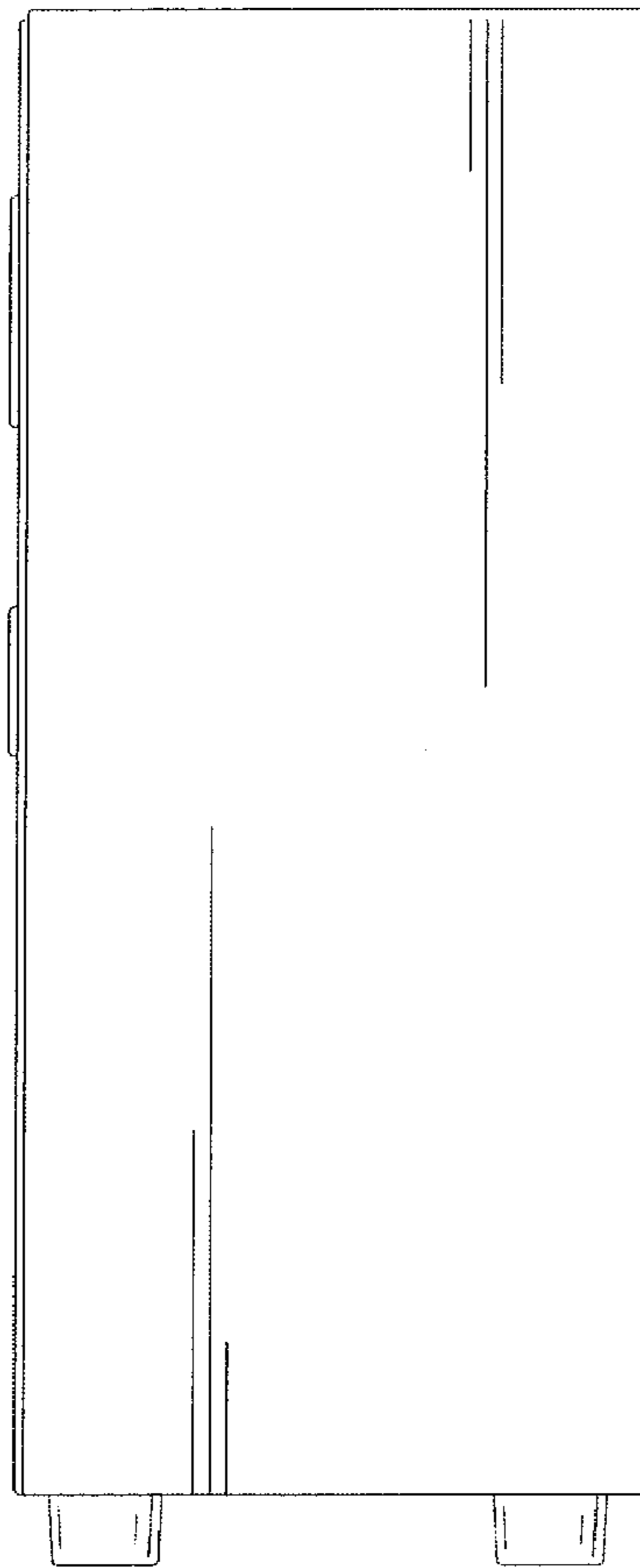

FIG. 15



FIG. 16

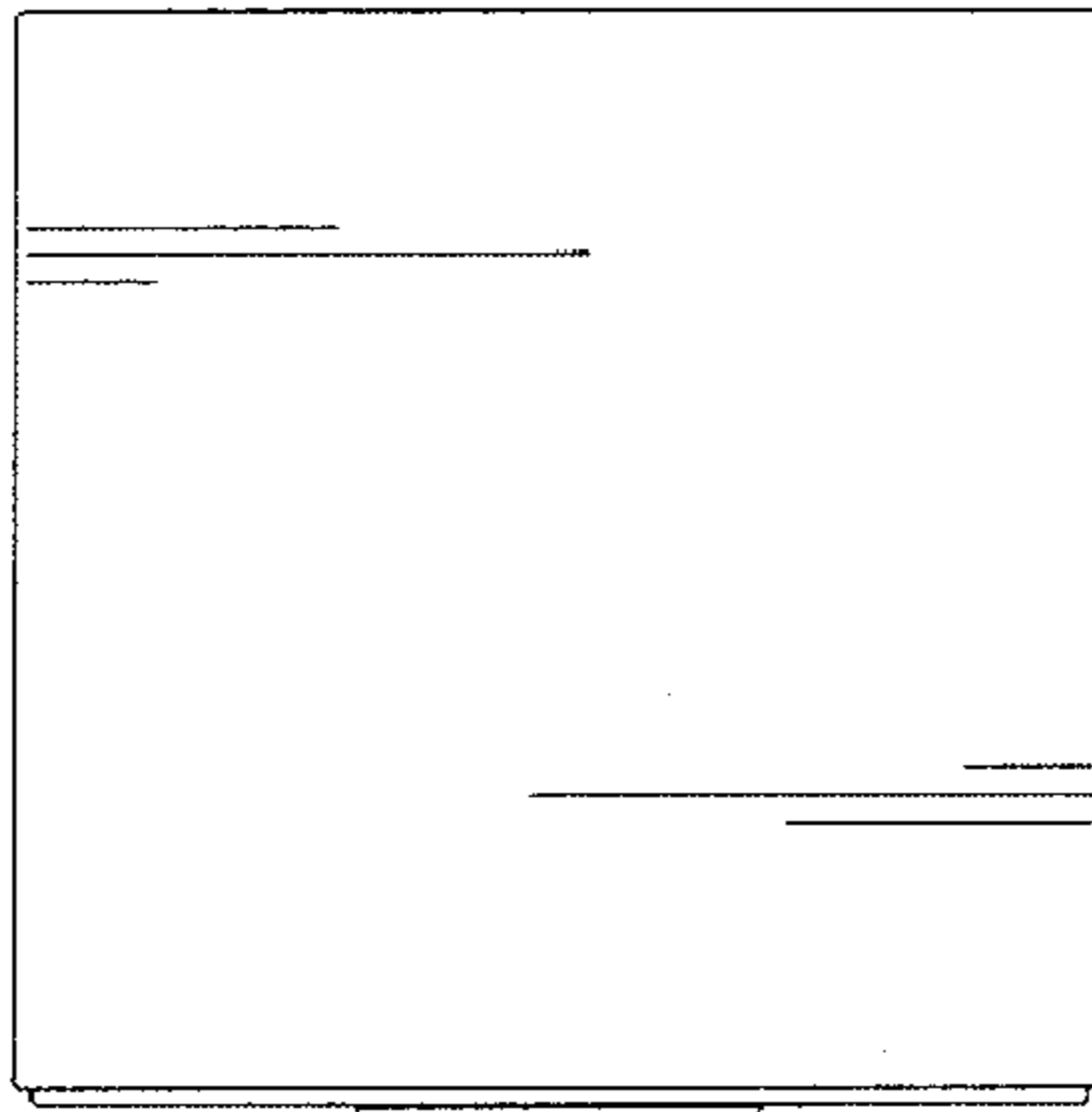

FIG. 17

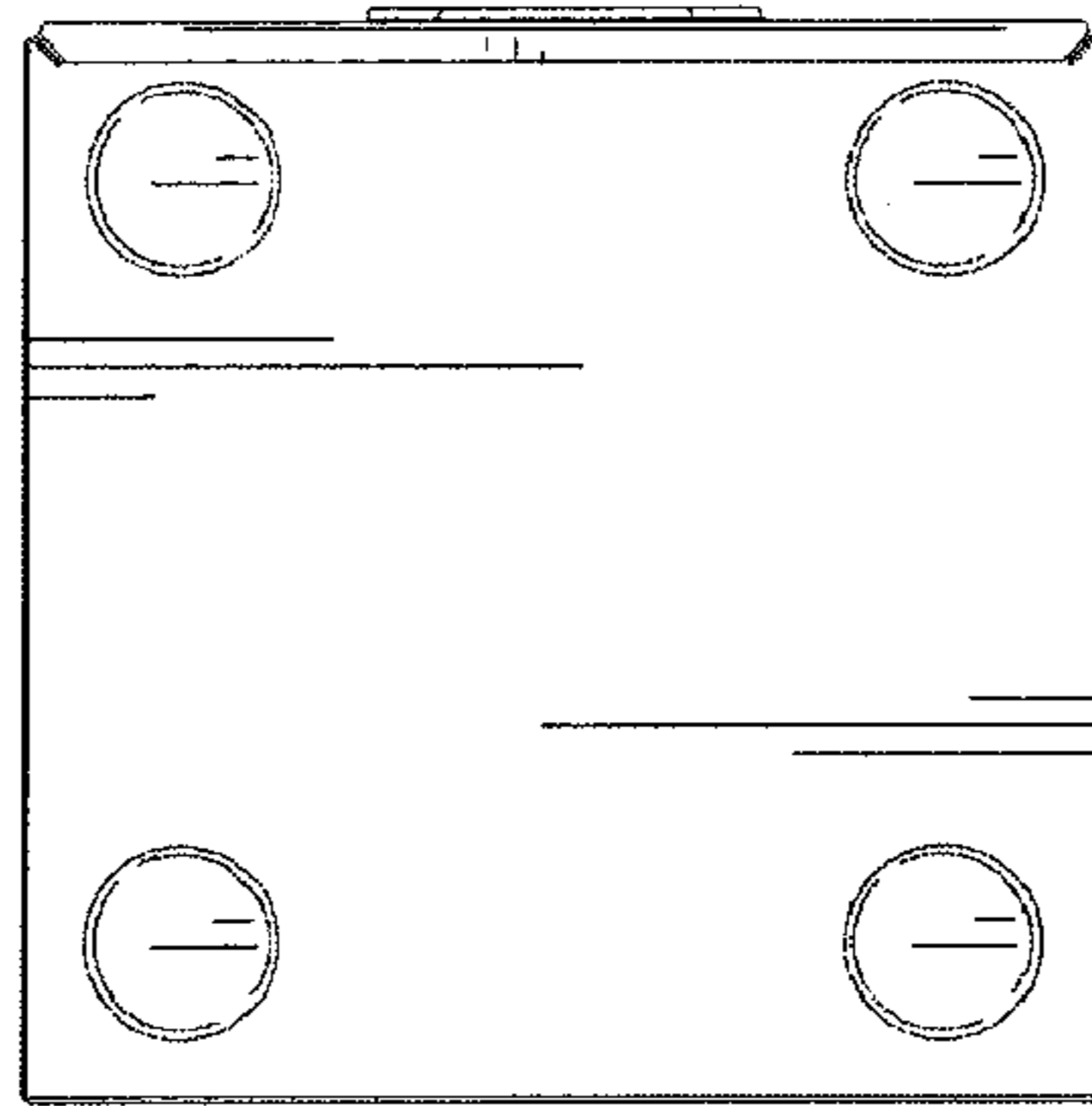

FIG. 18

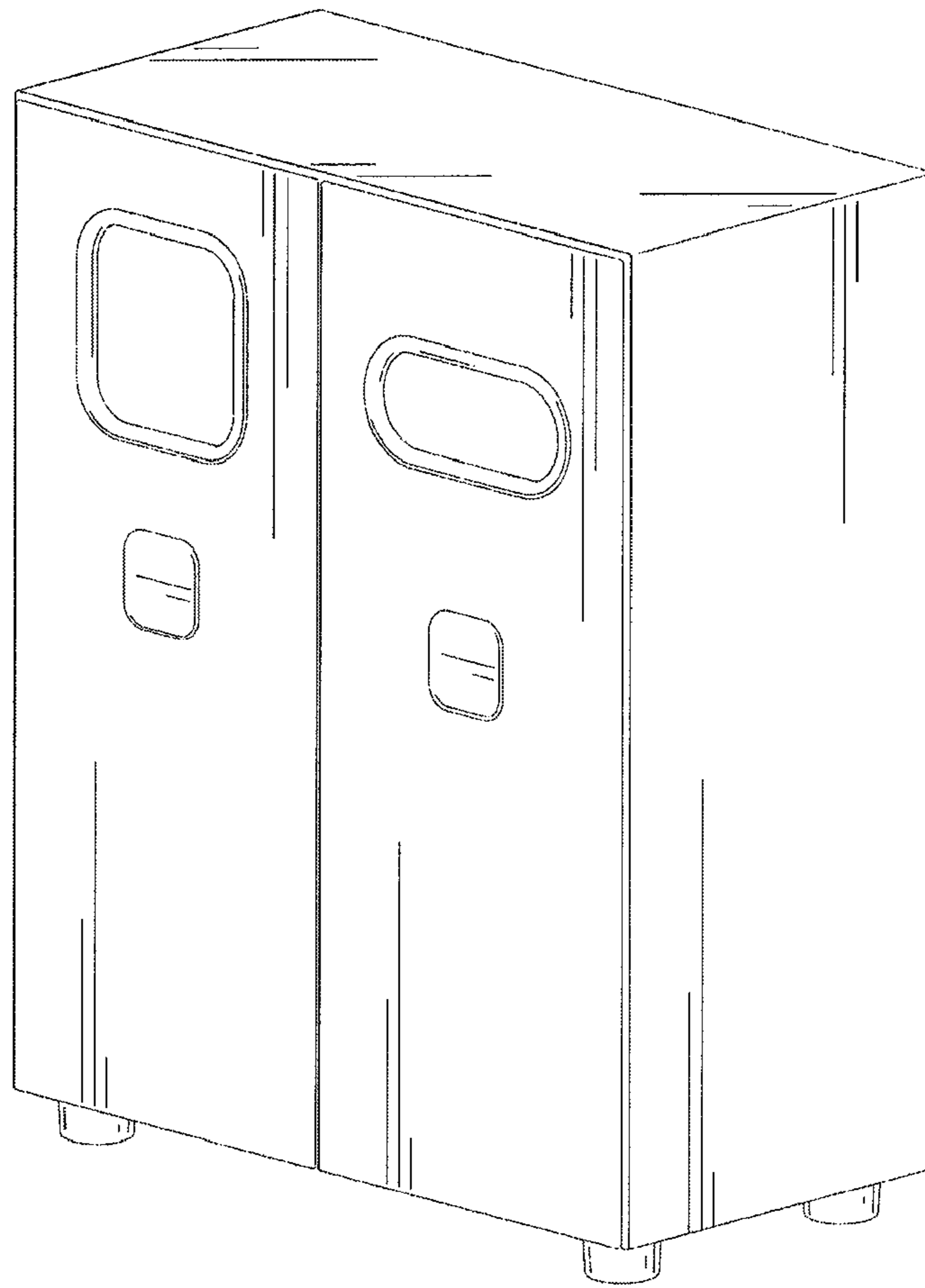

FIG. 19

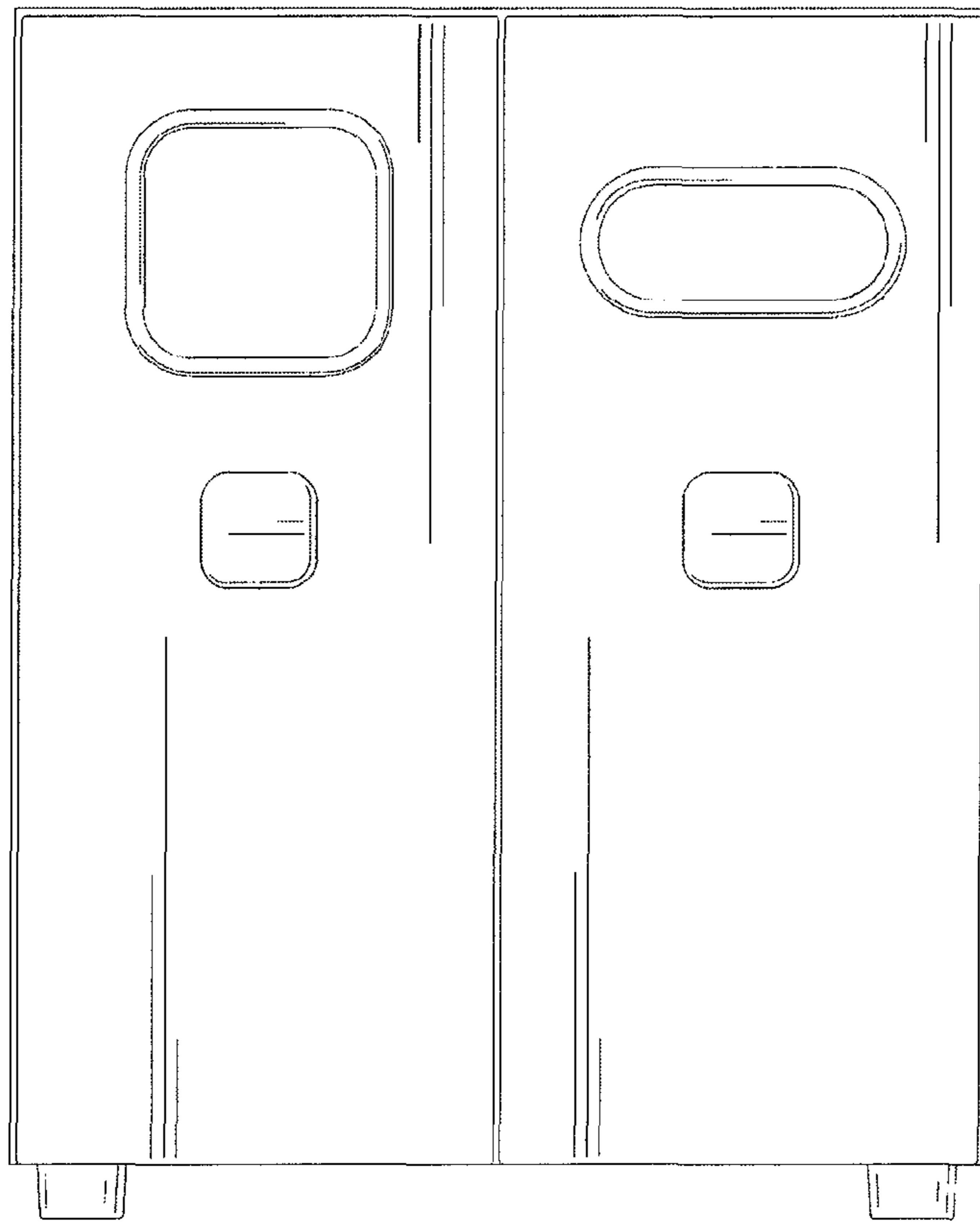

FIG. 20

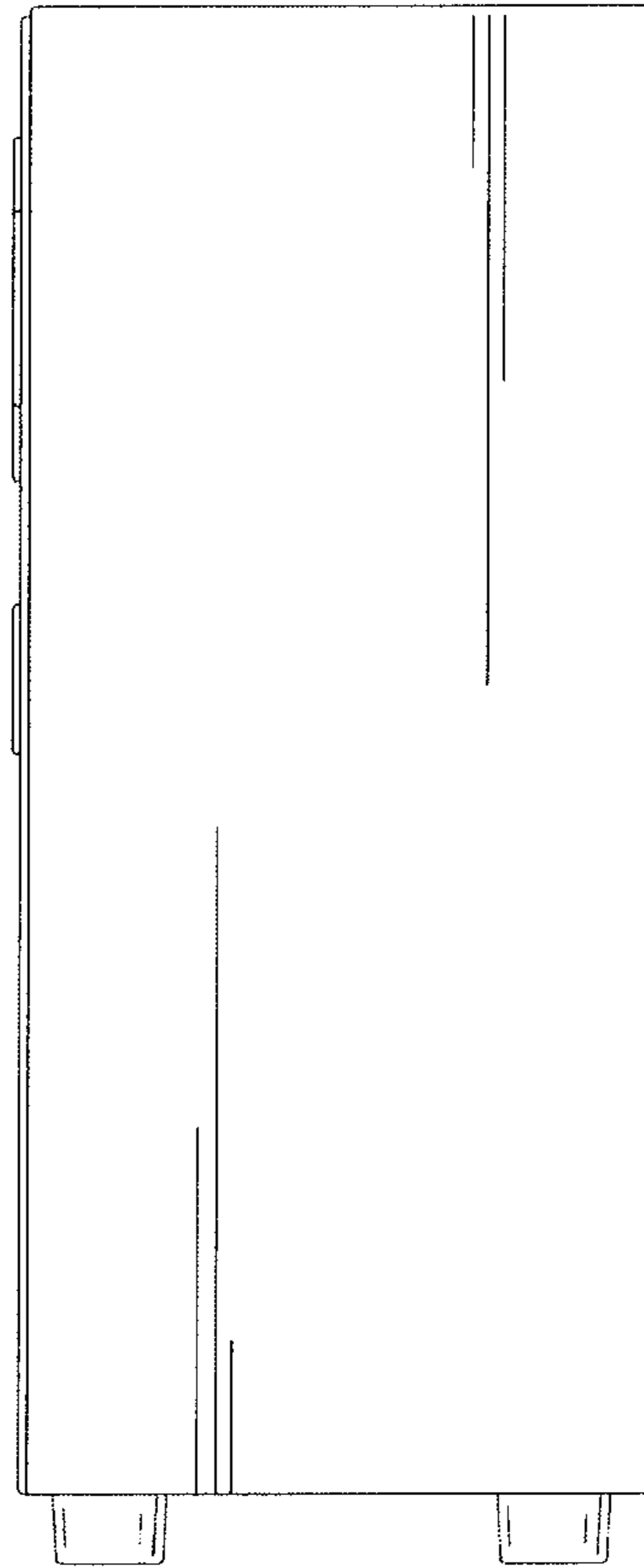

FIG. 21

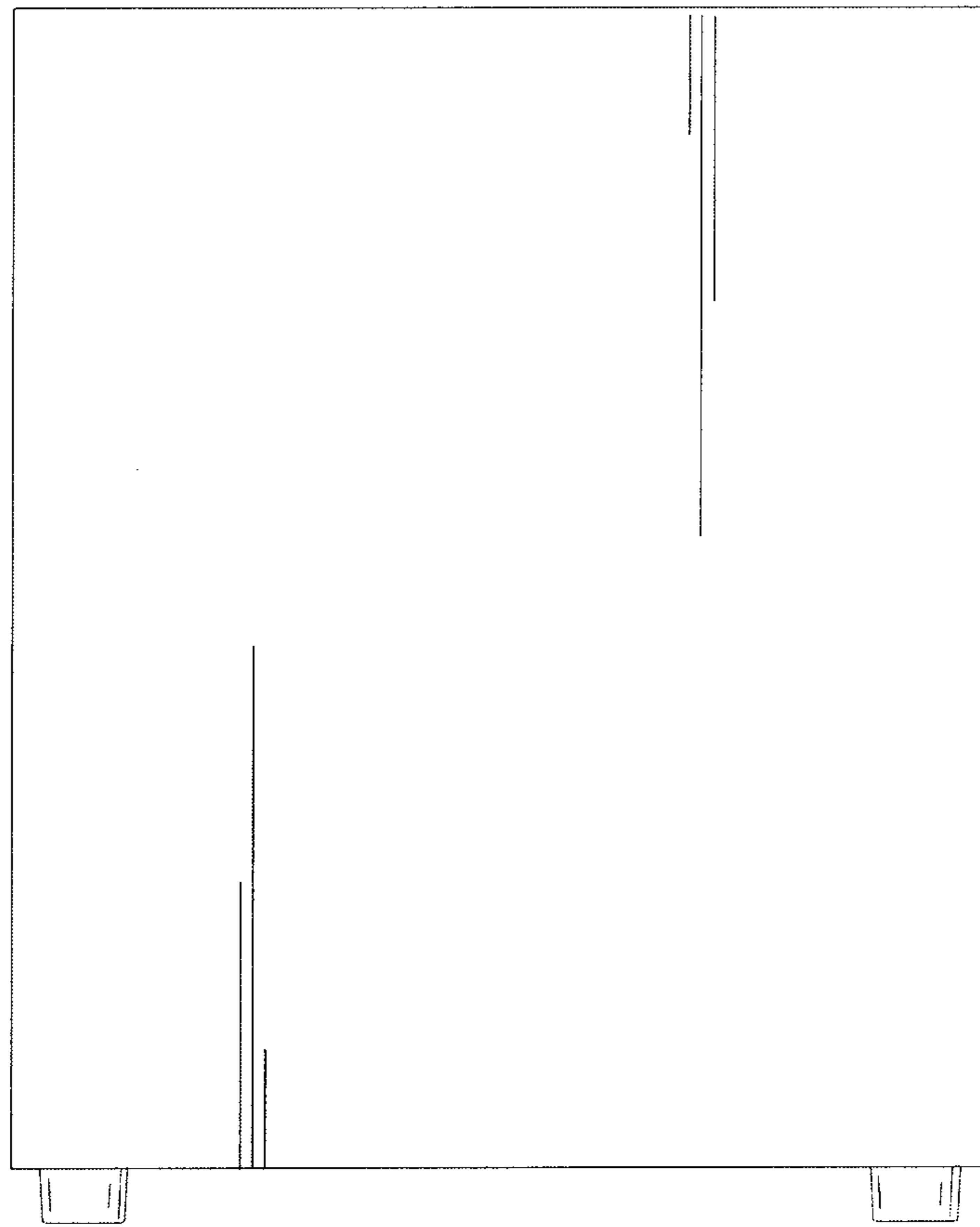

FIG. 22

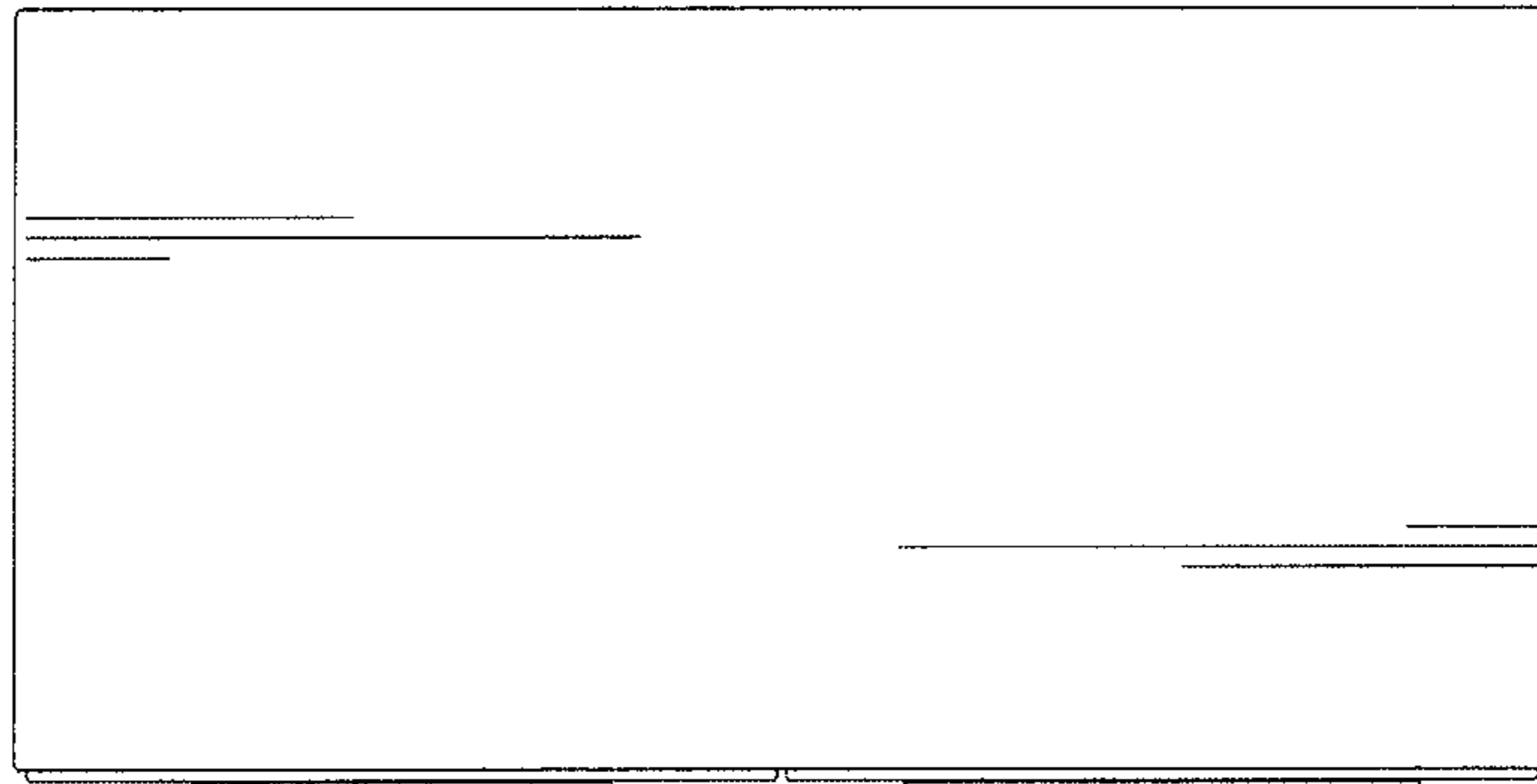

FIG. 23

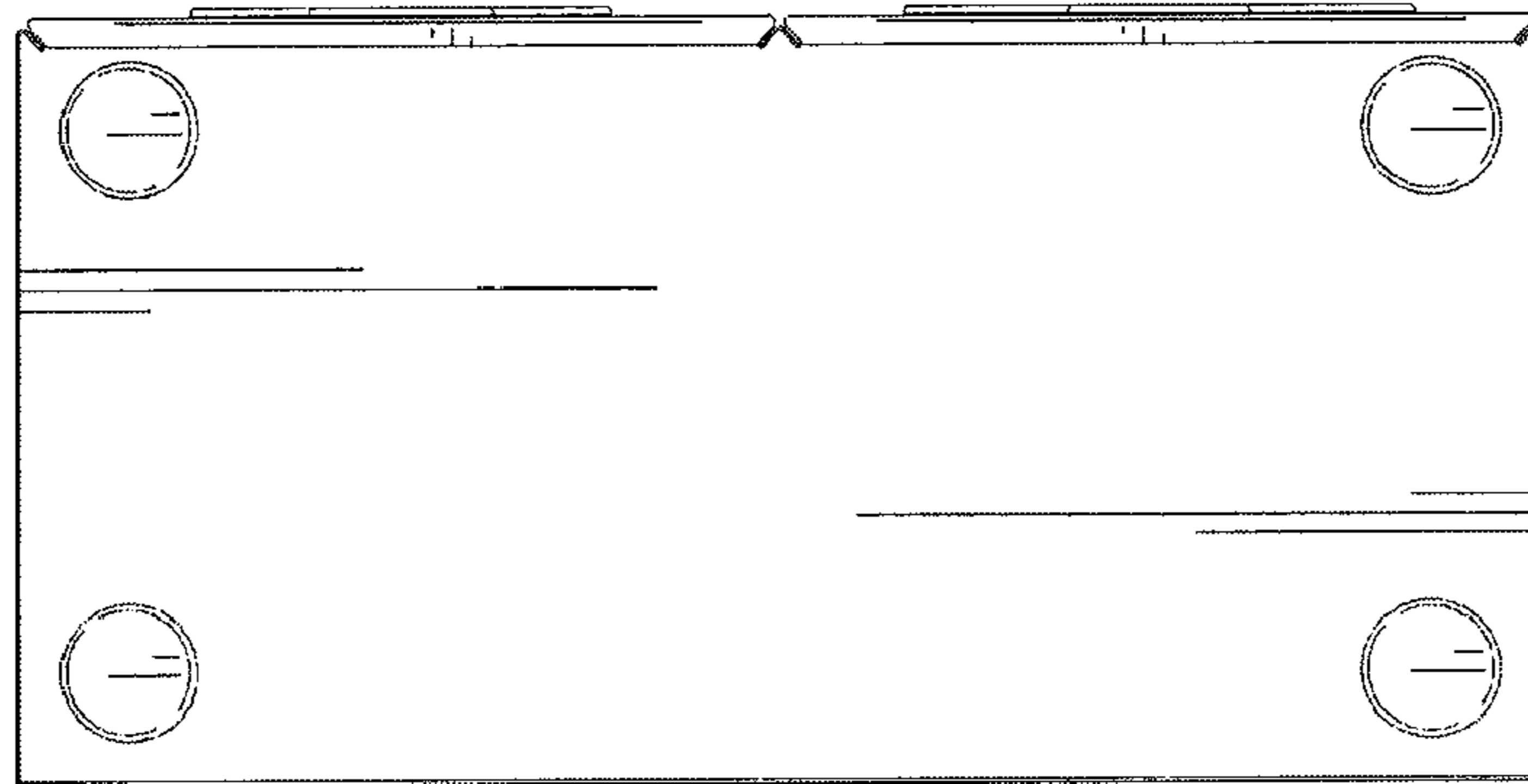

FIG. 24

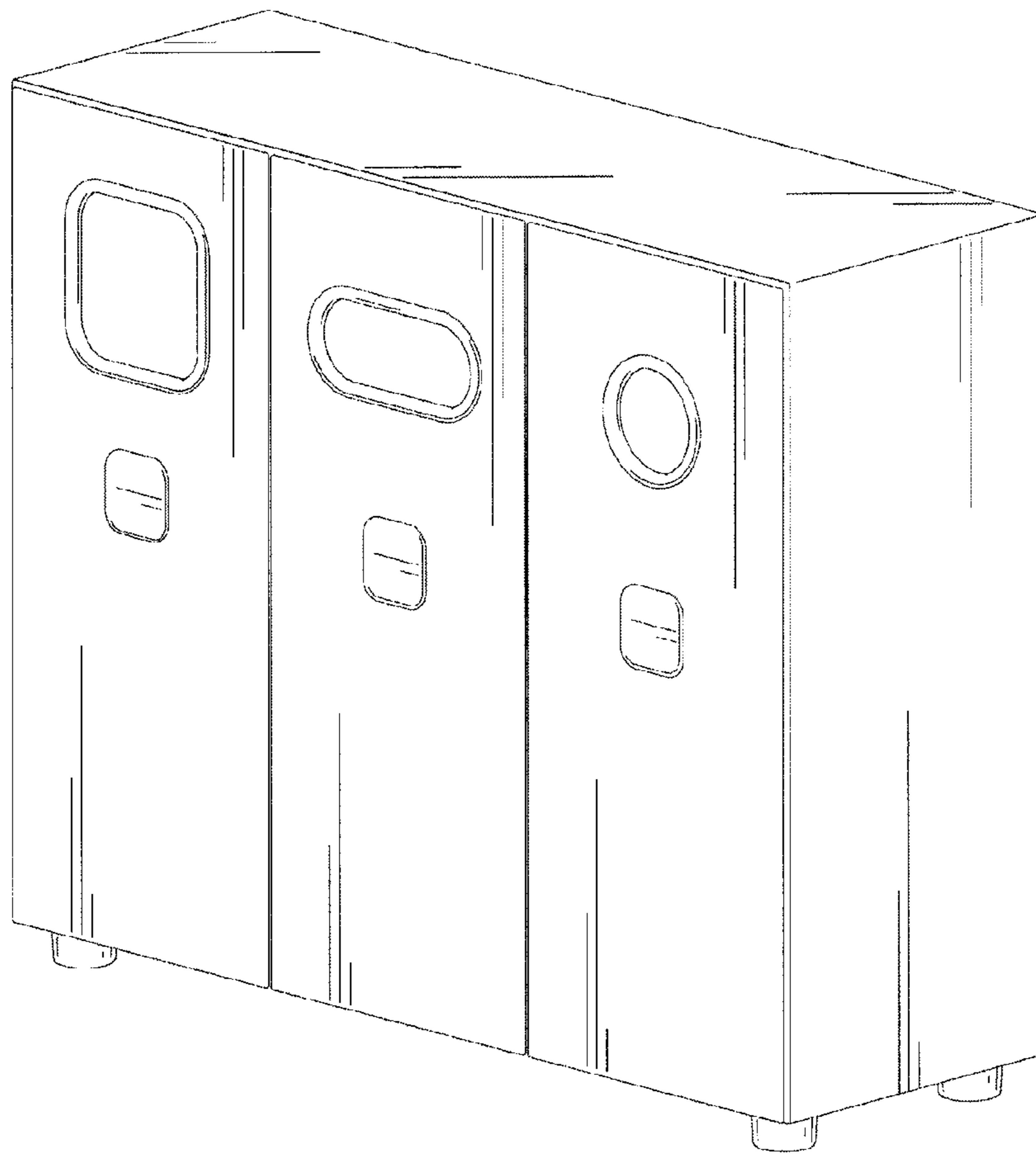

FIG. 25

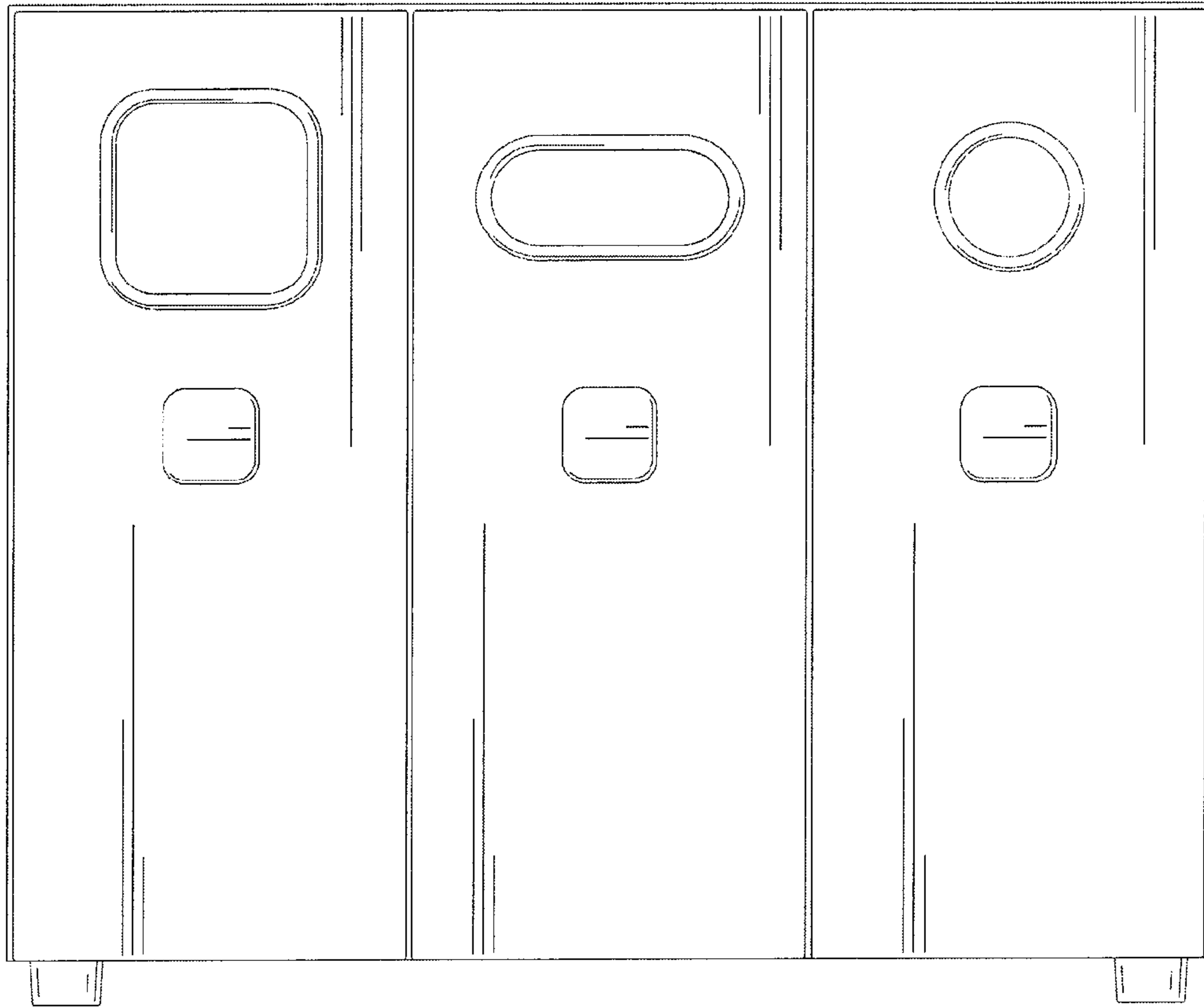

FIG. 26

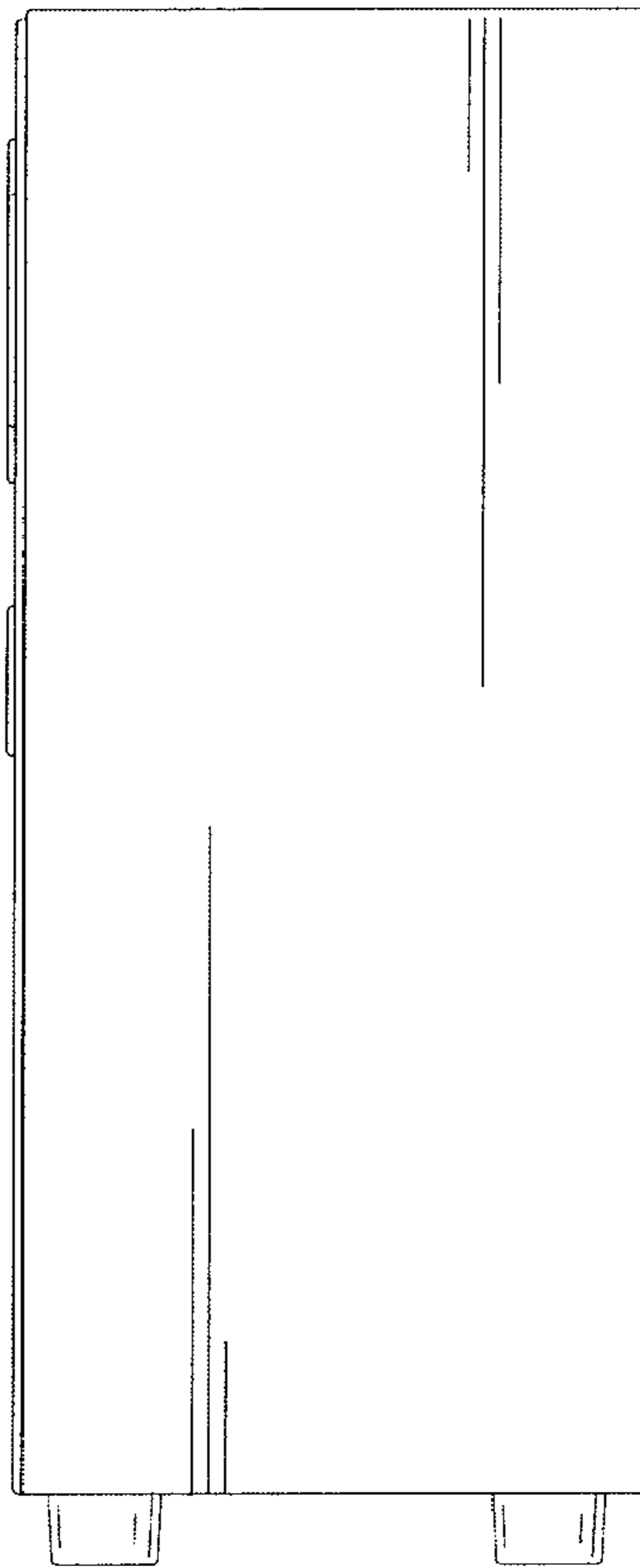

FIG. 27

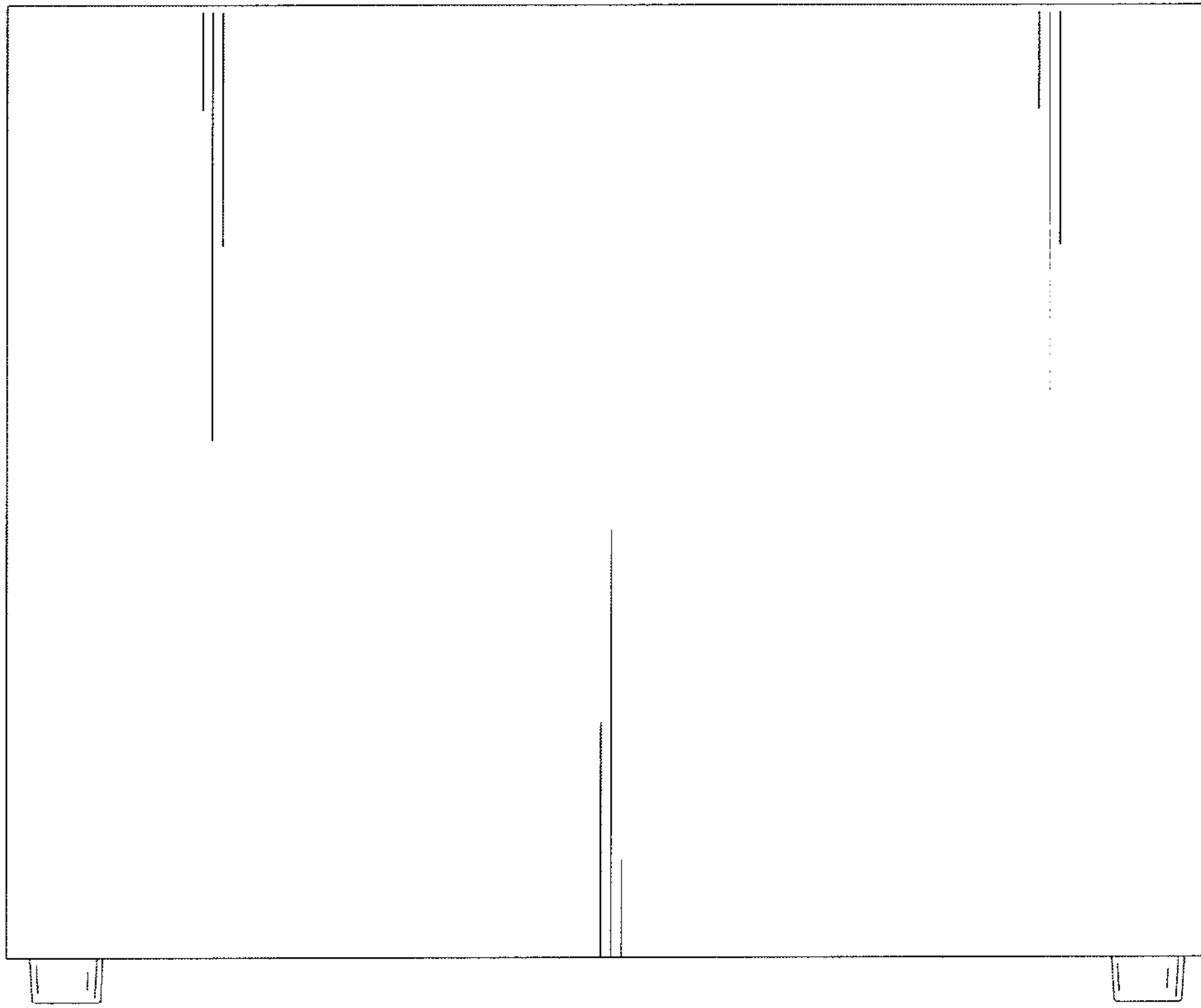

FIG. 28

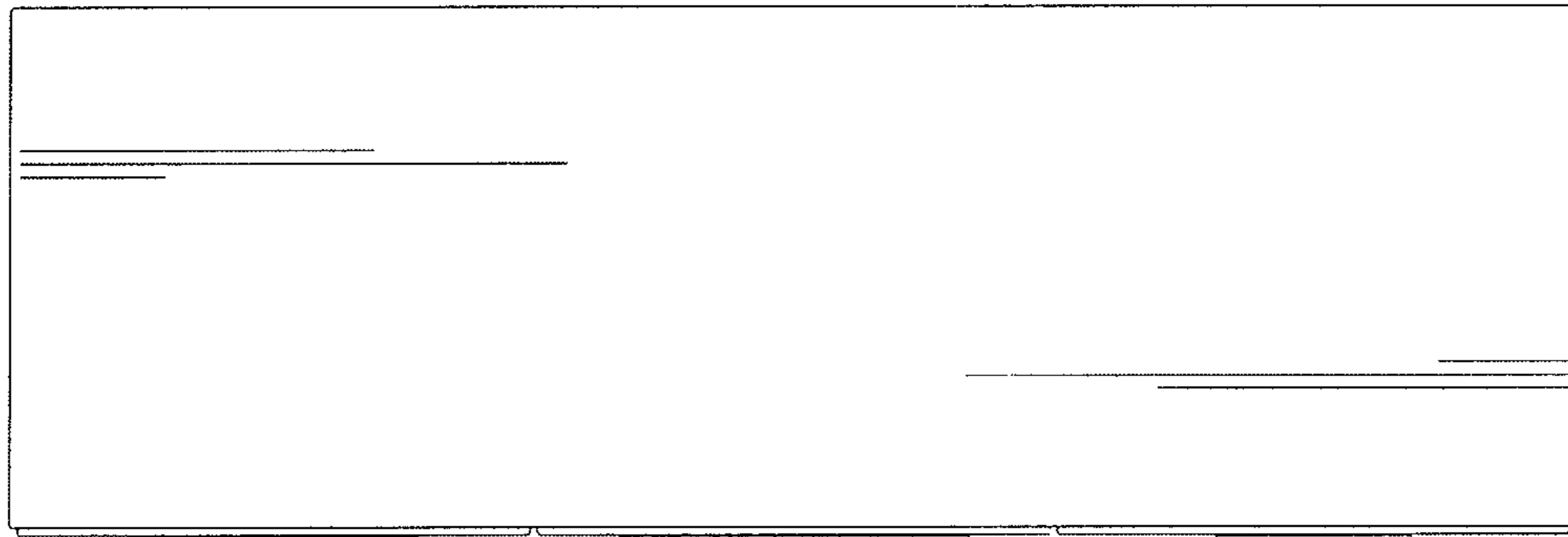

FIG. 29

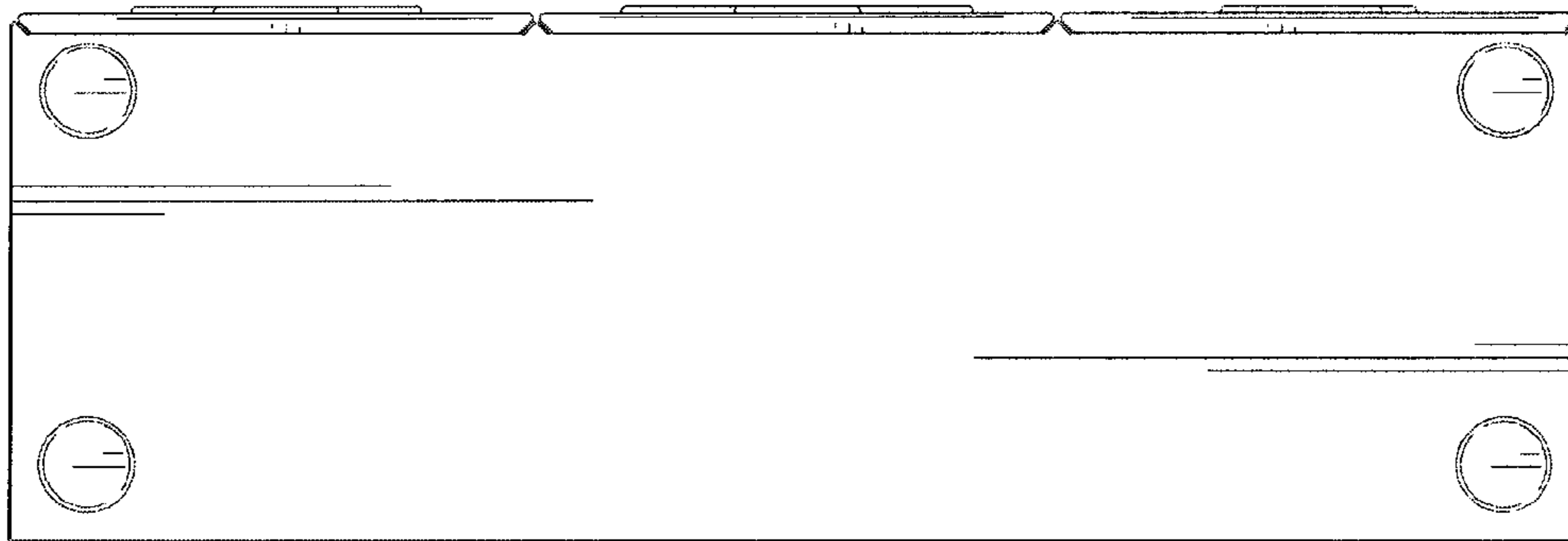

FIG. 30