



US00D652590S

(12) **United States Design Patent**
Pedlar

(10) **Patent No.:** **US D652,590 S**
(45) **Date of Patent:** **** Jan. 17, 2012**

- (54) **CLEANING WAND**
- (75) Inventor: **Roger Pedlar**, Lakewood, CO (US)
- (73) Assignee: **Kärcher North America, Inc.**,
Englewood, CO (US)
- (**) Term: **14 Years**
- (21) Appl. No.: **29/340,785**
- (22) Filed: **Jul. 24, 2009**
- (51) **LOC (9) Cl.** **15-05**
- (52) **U.S. Cl.** **D32/25**
- (58) **Field of Classification Search** D32/1,
D32/15, 25; 15/302, 320-323, 410-411;
294/54.5; 37/273, 278; 287/7; D8/8, 10,
D8/13; D30/162; D34/28
See application file for complete search history.

D191,899 S 12/1961 McKnight
3,078,604 A * 2/1963 Neuman 294/54.5
3,136,574 A * 6/1964 Pasquale 294/54.5
(Continued)

FOREIGN PATENT DOCUMENTS

GB 927750 6/1963

OTHER PUBLICATIONS

Commodore 20, Windsor Industries, Mar. 5, 2008, 2 pages.

(Continued)

Primary Examiner — T. Chase Nelson
Assistant Examiner — Kathleen M Sims
(74) *Attorney, Agent, or Firm* — Sheridan Ross P.C.

(57) **CLAIM**
The ornamental design for a cleaning wand, as shown and described.

DESCRIPTION

FIG. 1 is a front perspective view of a cleaning wand showing my new design;
FIG. 2 is a front elevation view of the invention illustrated in FIG. 1;
FIG. 3 is a top plan view of the invention illustrated in FIG. 1;
FIG. 4 is a right elevation view of the invention illustrated in FIG. 1;
FIG. 5 is a bottom plan view of the invention illustrated in FIG. 1;
FIG. 6 is a left elevation view of the invention illustrated in FIG. 1; and,
FIG. 7 is a rear elevation view of the invention illustrated in FIG. 1.
The broken line showing of details in FIGS. 1-7 is included for the purpose of showing environmental portions of the cleaning wand and forms no part of the claimed design.

1 Claim, 3 Drawing Sheets

(56) **References Cited**

U.S. PATENT DOCUMENTS

981,893	A *	1/1911	Spencer	15/411
1,012,195	A *	12/1911	English	15/410
1,081,340	A	12/1913	Spangler	
1,086,367	A *	2/1914	Spangler	285/7
1,104,613	A	7/1914	Bodey	
1,119,393	A	12/1914	Binkley	
1,180,679	A	4/1916	Thompson	
1,237,793	A	8/1917	Krantz	
1,348,585	A	8/1920	Rosenfield	
1,440,759	A	1/1923	Wright	
1,543,972	A	6/1925	Adams	
1,764,666	A	6/1930	White	
1,951,316	A	3/1934	Allen	
1,976,998	A	10/1934	Kirby	
2,027,544	A	1/1936	Einar	
2,184,401	A	12/1939	Sellers	
2,590,143	A *	3/1952	Adams, Jr. et al.	37/273
2,629,126	A	2/1953	Brown, Jr.	

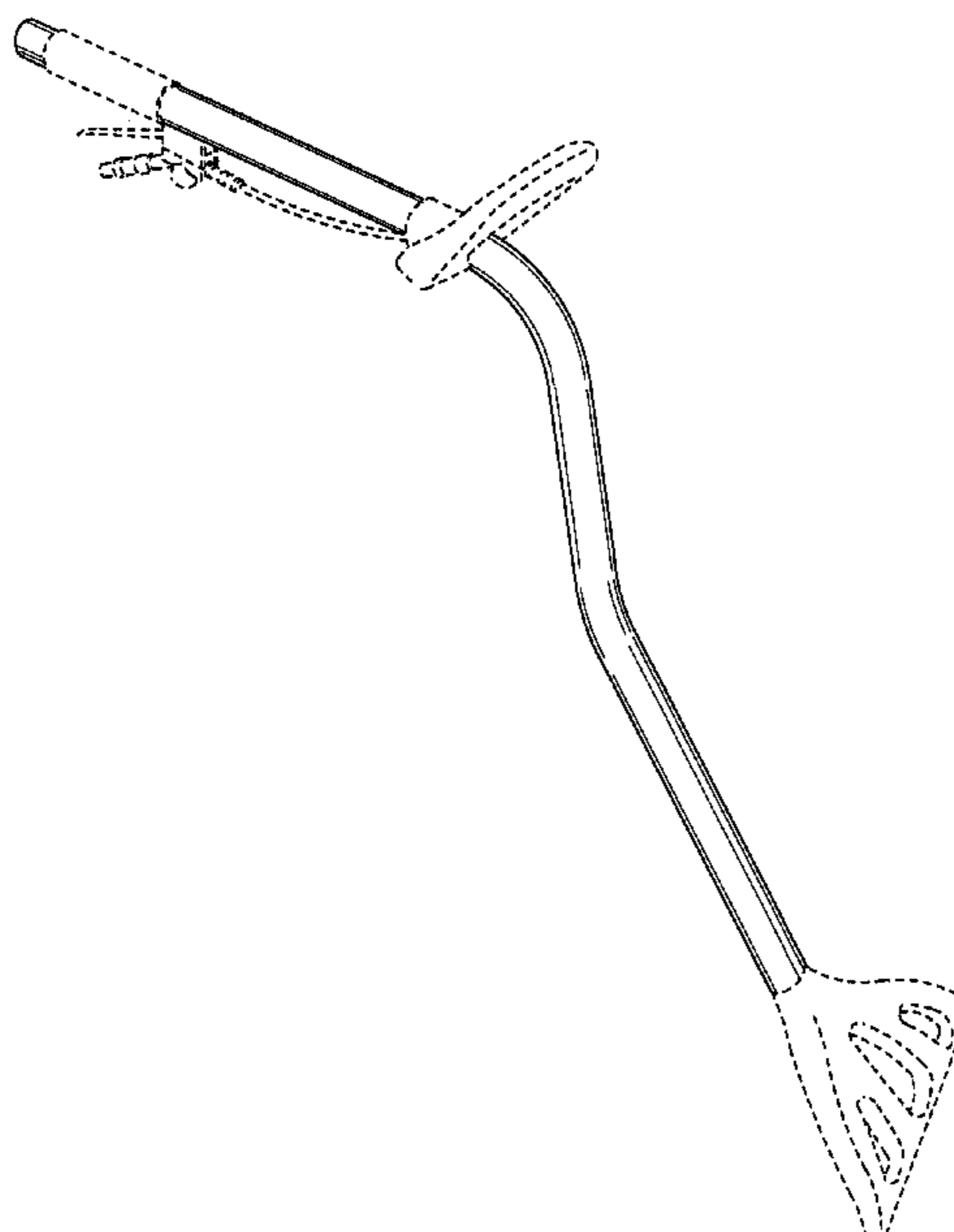

US D652,590 S

Page 2

U.S. PATENT DOCUMENTS

3,222,699	A *	12/1965	Zeisig	7/158	6,125,502	A	10/2000	Hammeken et al.
D215,875	S	11/1969	Hoadley		6,131,240	A	10/2000	Shark et al.
3,565,464	A *	2/1971	Wolf	285/7	6,199,245	B1	3/2001	Blessing
3,705,437	A *	12/1972	Rukavina et al.	15/302	6,209,925	B1	4/2001	Edin
3,747,155	A	7/1973	Koellisch		6,263,539	B1	7/2001	Baig
D229,932	S *	1/1974	Goodrich	D32/15	6,266,892	B1	7/2001	Haynie
3,909,197	A *	9/1975	Cremers	8/158	6,298,577	B1	10/2001	Haynie
3,962,745	A *	6/1976	Collier	15/322	6,453,506	B1	9/2002	Sumner
D241,545	S *	9/1976	Smith	D32/15	D476,200	S *	6/2003	Van Wambeke et al.
4,009,728	A	3/1977	Parise et al.		6,684,459	B2	2/2004	Dickhaus
D244,532	S *	5/1977	Poston	D32/15	6,742,222	B2	6/2004	Furr-Britt et al.
4,075,733	A	2/1978	Parise et al.		6,904,640	B2	6/2005	Jin et al.
D250,826	S *	1/1979	Newman	D32/15	D521,530	S	5/2006	Cohen
4,139,922	A	2/1979	Fitch		7,134,208	B2 *	11/2006	Wilkinson et al.
4,197,764	A	4/1980	Auernhammer		D538,986	S	3/2007	Ingram
4,391,017	A	7/1983	Bruensicke		D558,943	S *	1/2008	Labarbera et al.
4,472,855	A *	9/1984	Murphy et al.	15/323	D566,357	S	4/2008	Santiago
4,505,040	A	3/1985	Everts		7,383,609	B2	6/2008	Ji
4,704,758	A	11/1987	Hoffman		D593,821	S *	6/2009	Kopp et al.
5,060,343	A	10/1991	Nisenbaum		7,694,382	B2 *	4/2010	Williams et al.
5,075,921	A *	12/1991	Gleadall	15/322	D623,807	S *	9/2010	Teren
5,109,568	A	5/1992	Rohn et al.		D631,633	S *	1/2011	Navarre, II
5,113,547	A	5/1992	Mayhew		2006/0070265	A1	4/2006	Cohen
5,125,130	A	6/1992	Stanish		2009/0193615	A1	8/2009	Nguyen
5,159,769	A *	11/1992	Odorisio	37/278	2009/0320234	A1	12/2009	Stoy et al.
5,184,371	A	2/1993	Rands		2010/0037425	A1	2/2010	Genn
5,184,372	A	2/1993	Mache					
D347,504	S	5/1994	Furcron et al.					
5,555,599	A	9/1996	Markley					
D376,742	S *	12/1996	Filowiak et al.	D8/13				
5,623,743	A	4/1997	Burgoon et al.					
5,697,119	A *	12/1997	Mussalo	15/320				
D391,704	S	3/1998	Facer					
5,891,198	A *	4/1999	Pearlstein	8/158				
D432,373	S *	10/2000	Fox	D8/10				

OTHER PUBLICATIONS

The Green Team, Solus 500, U.S. Products, CM/Cleaning & Maintenance Management, Jun. 2008, p. 27.
 U.S. Appl. No. 29/340,786, filed Jul. 24, 2009, Pierce.
 Notice of Allowability for U.S. Appl. No. 29/340,786, mailed Apr. 7, 2010.

* cited by examiner

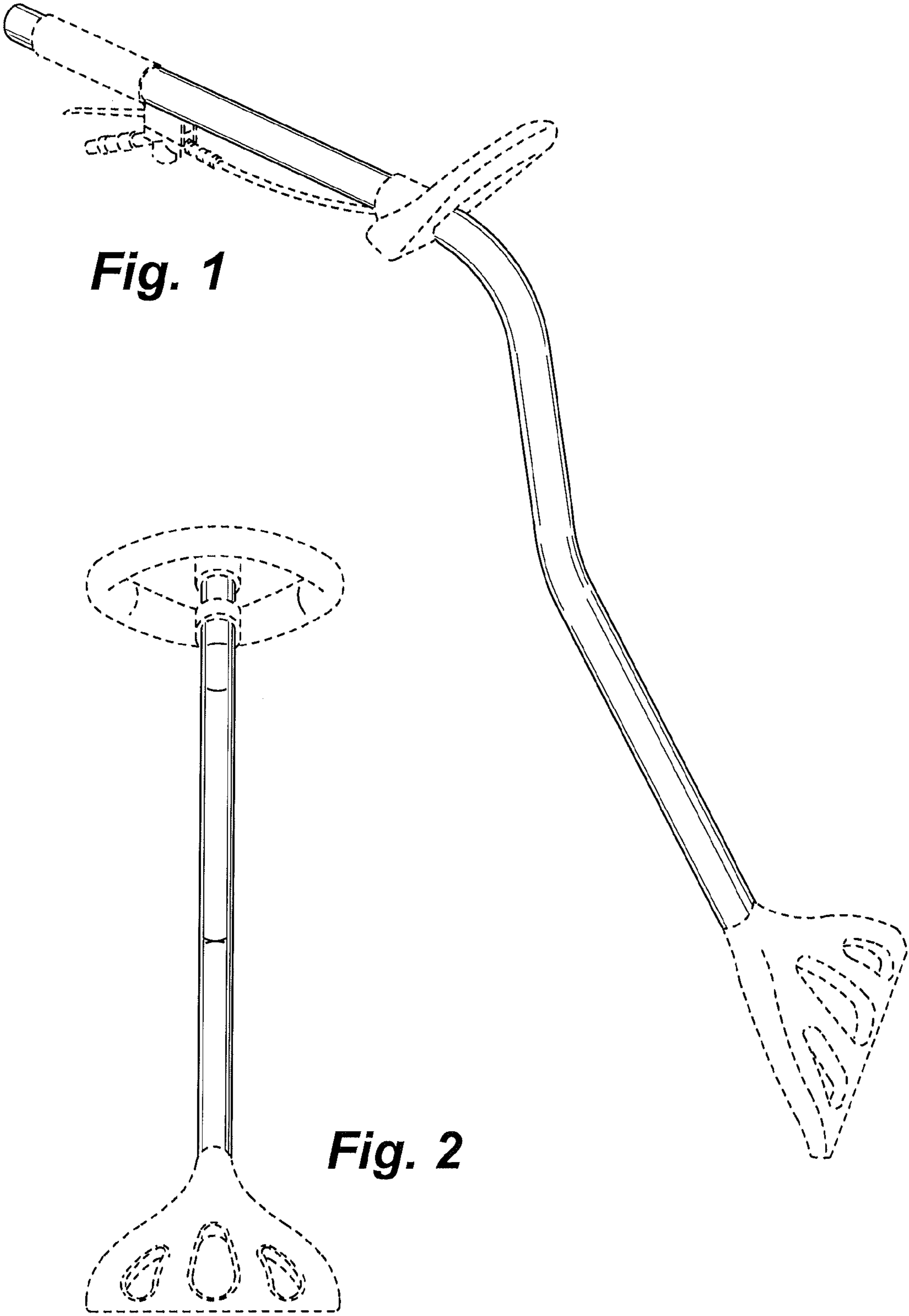

Fig. 1

Fig. 2

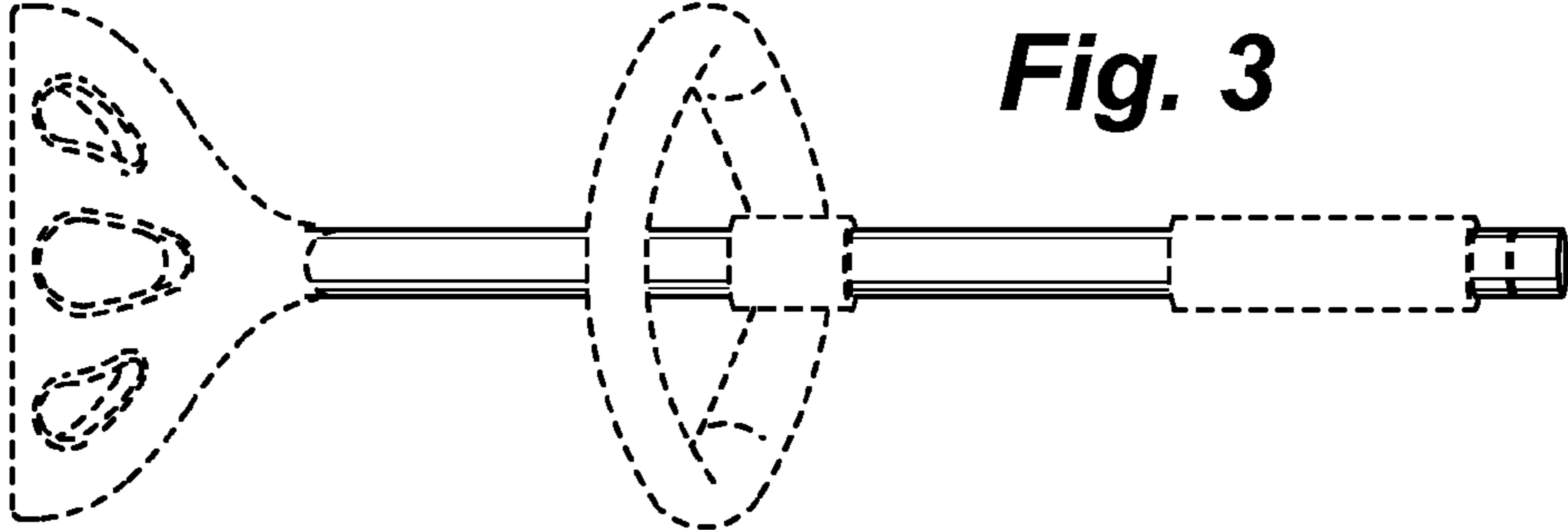

Fig. 3

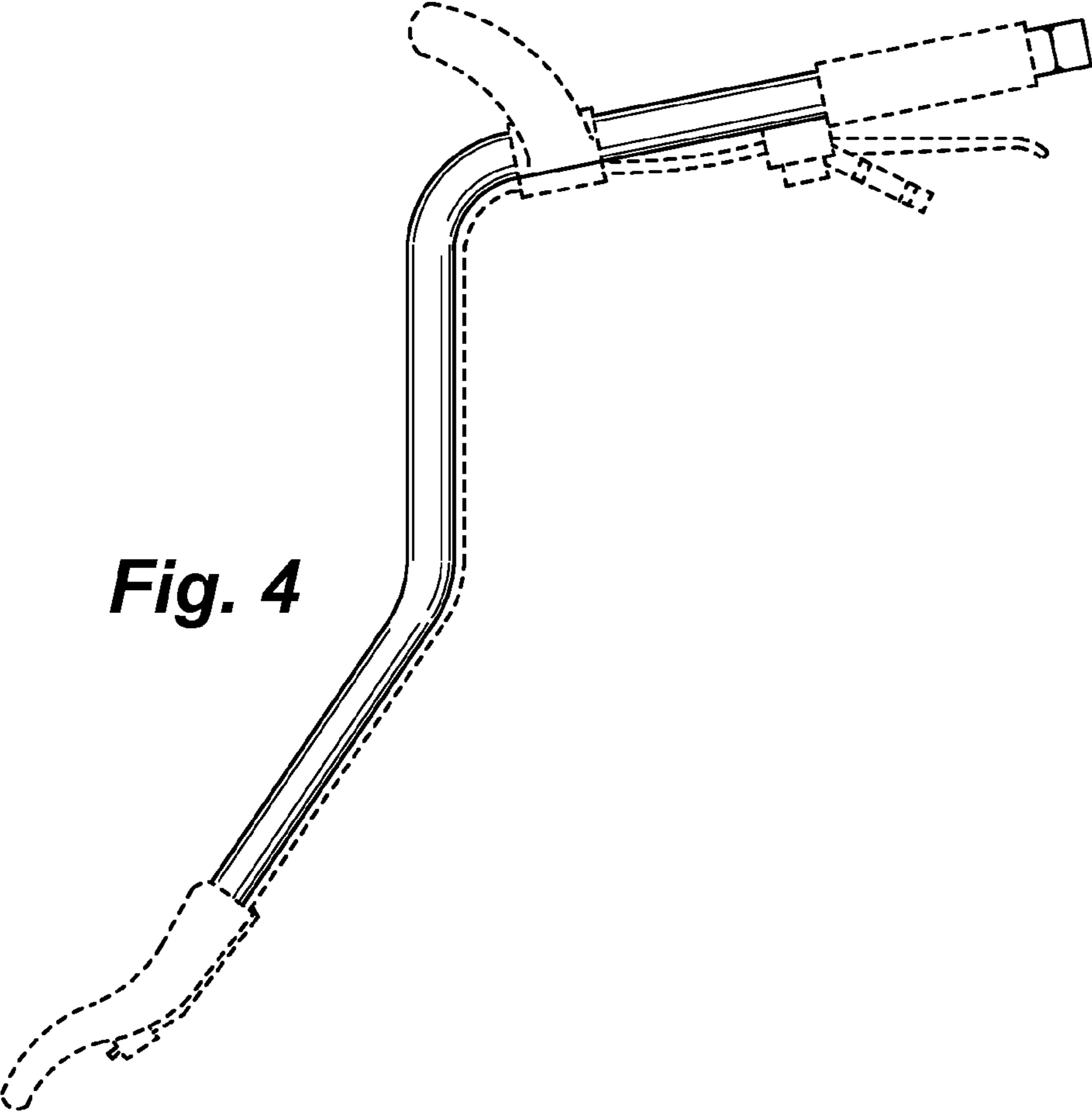

Fig. 4

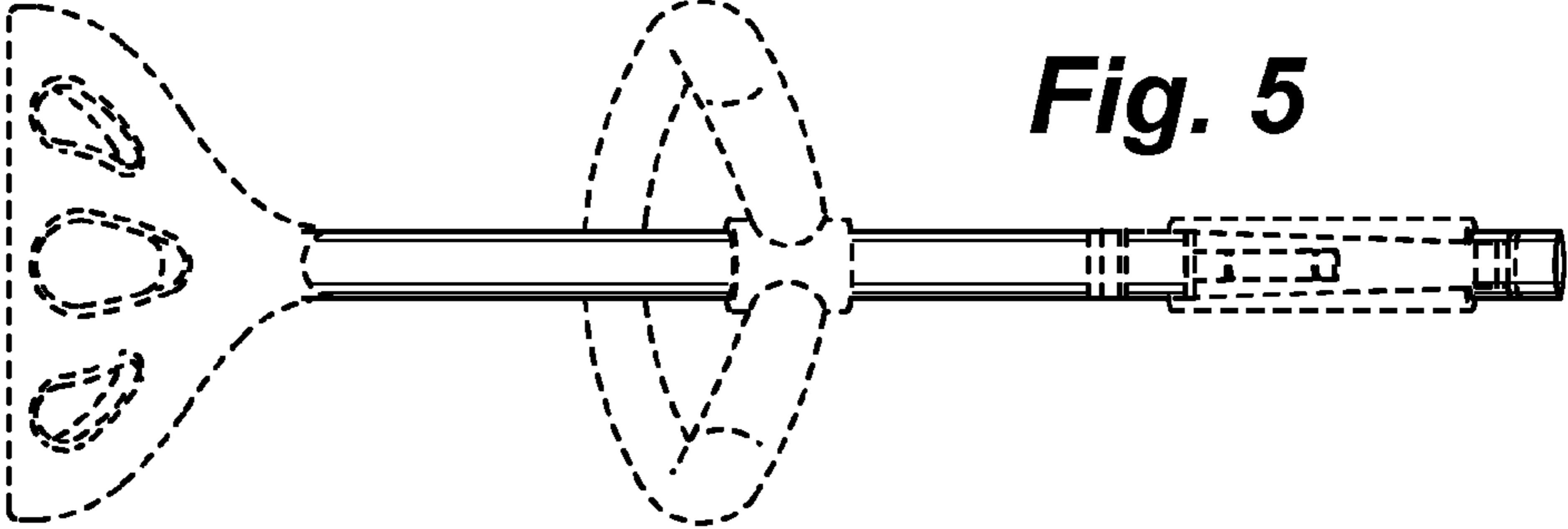

Fig. 5

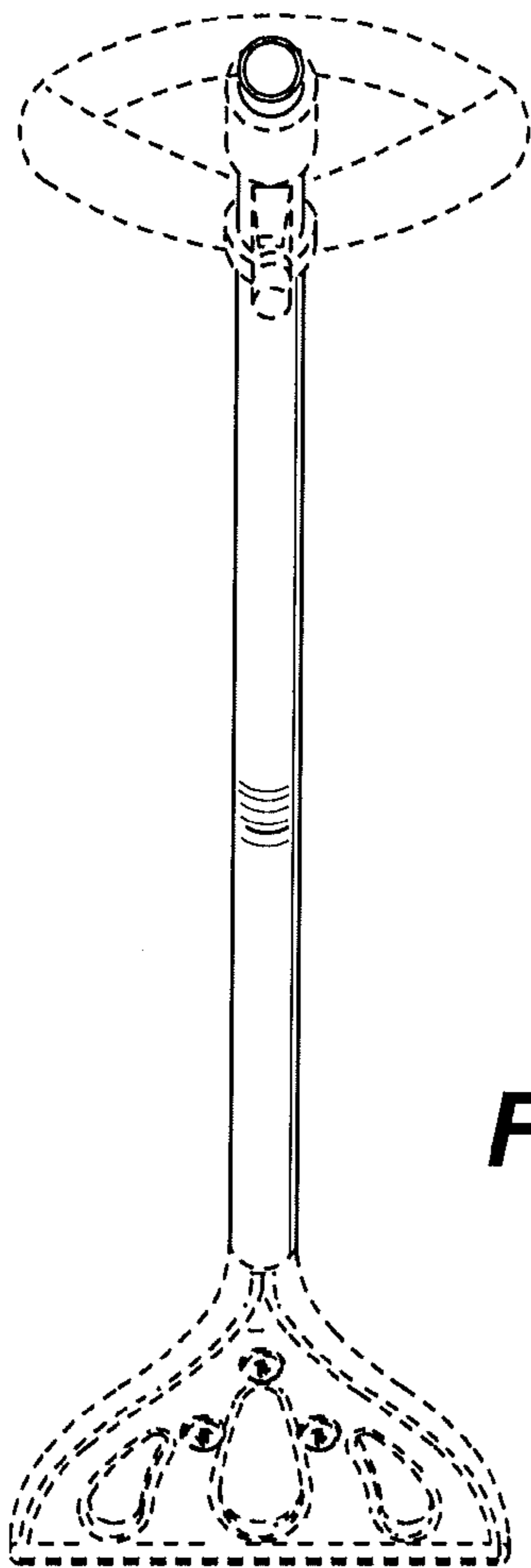
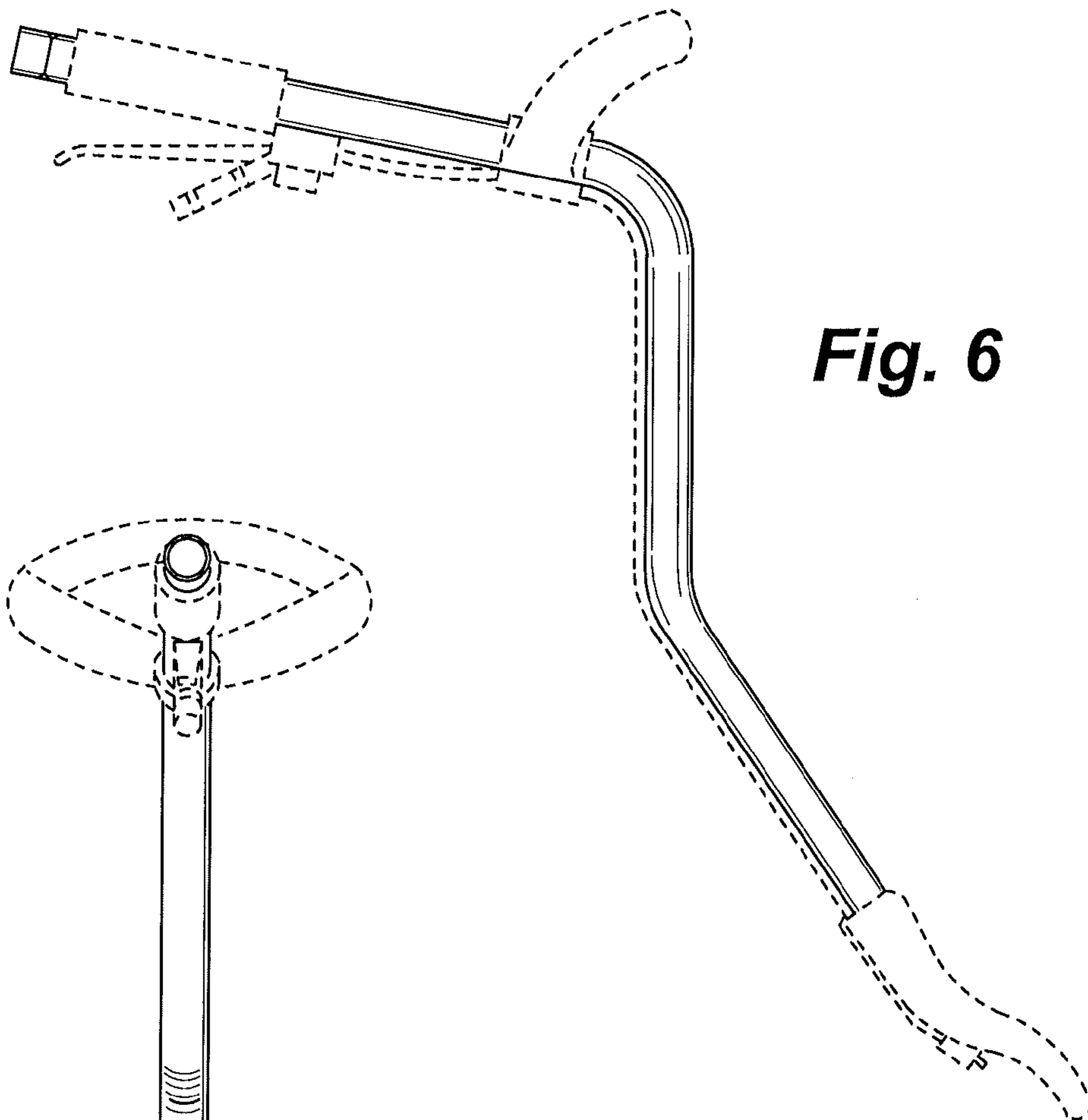

Fig. 7