



US00D652464S

(12) **United States Design Patent**
Bertone et al.

(10) **Patent No.:** **US D652,464 S**
(45) **Date of Patent:** **** Jan. 17, 2012**

(54) **GOLF CLUB**

DESCRIPTION

(75) Inventors: **Antonio M. Bertone**, Winchester, MA (US); **Robert A. Phillion**, Carlsbad, CA (US); **Douglas E. Roberts**, Carlsbad, CA (US); **Brian S. Zender**, Carlsbad, CA (US); **Thomas W. Preece**, San Diego, CA (US)

(73) Assignee: **Cobra Golf Incorporated**, Carlsbad, CA (US)

(**) Term: **14 Years**

(21) Appl. No.: **29/376,169**

(22) Filed: **Oct. 1, 2010**

(51) **LOC (9) Cl.** **21-02**

(52) **U.S. Cl.** **D21/733; D21/756**

(58) **Field of Classification Search** D21/733,
D21/752, 759, 756, 757; 473/324-331, 343-346,
473/300-303, 316-323

See application file for complete search history.

(56) **References Cited**

U.S. PATENT DOCUMENTS

D453,365 S *	2/2002	Carr et al.	D21/752
D461,513 S *	8/2002	Madore et al.	D21/733
D461,862 S *	8/2002	Madore et al.	D21/752
D537,895 S *	3/2007	Breier et al.	D21/752
D553,210 S *	10/2007	Harvell et al.	D21/752
D553,211 S *	10/2007	Harvell et al.	D21/752
D591,812 S *	5/2009	Breier et al.	D21/752
D618,294 S *	6/2010	Morris et al.	D21/752
2009/0314398 A1 *	12/2009	Shaar, Jr.	150/160

* cited by examiner

Primary Examiner — Mitchell Siegel

(74) *Attorney, Agent, or Firm* — Mark S. Leonardo; Brown Rudnick LLP

(57) **CLAIM**

The ornamental design for a golf club, as shown and described.

FIG. 1 is a bottom, heel side perspective view of a golf club embodying our new design; the drawing is lined for color, illustrating a white grip, white shaft, and white club head crown;

FIG. 2 is a heel side view thereof; the drawing is lined for color, illustrating a white club grip, white shaft, and white club head crown;

FIG. 3 is a toe side view thereof; the drawing is lined for color, illustrating a white club grip, white shaft, and white club head crown;

FIG. 4 is a back side view thereof; the drawing is lined for color, illustrating a white club grip, white shaft, and white club head crown;

FIG. 5 is a top side view thereof; the drawing is lined for color, illustrating a white club grip, white shaft, and white club head crown;

FIG. 6 is a bottom side view thereof; the drawing is lined for color, illustrating a white club grip, white shaft, and white club head crown;

FIG. 7 is a front side view thereof; the drawing is lined for color, illustrating a white club grip, white shaft, and white club head crown;

FIG. 8 is a bottom, heel side perspective view of a golf club embodying our new design; the drawing is lined for color, illustrating a white club grip, white shaft, and white club head crown;

FIG. 9 is a heel side view thereof; the drawing is lined for color, illustrating a white club grip, white shaft, and white club head crown;

FIG. 10 is a toe side view thereof; the drawing is lined for color, illustrating a white club grip, white shaft, and white club head crown;

FIG. 11 is a back side view thereof; the drawing is lined for color, illustrating a white club grip, white shaft, and white club head crown;

FIG. 12 is a top side view thereof; the drawing is lined for color, illustrating a white club grip, white shaft, and white club head crown;

FIG. 13 is a bottom side view thereof; the drawing is lined for color, illustrating a white club grip, white shaft, and white club head crown;

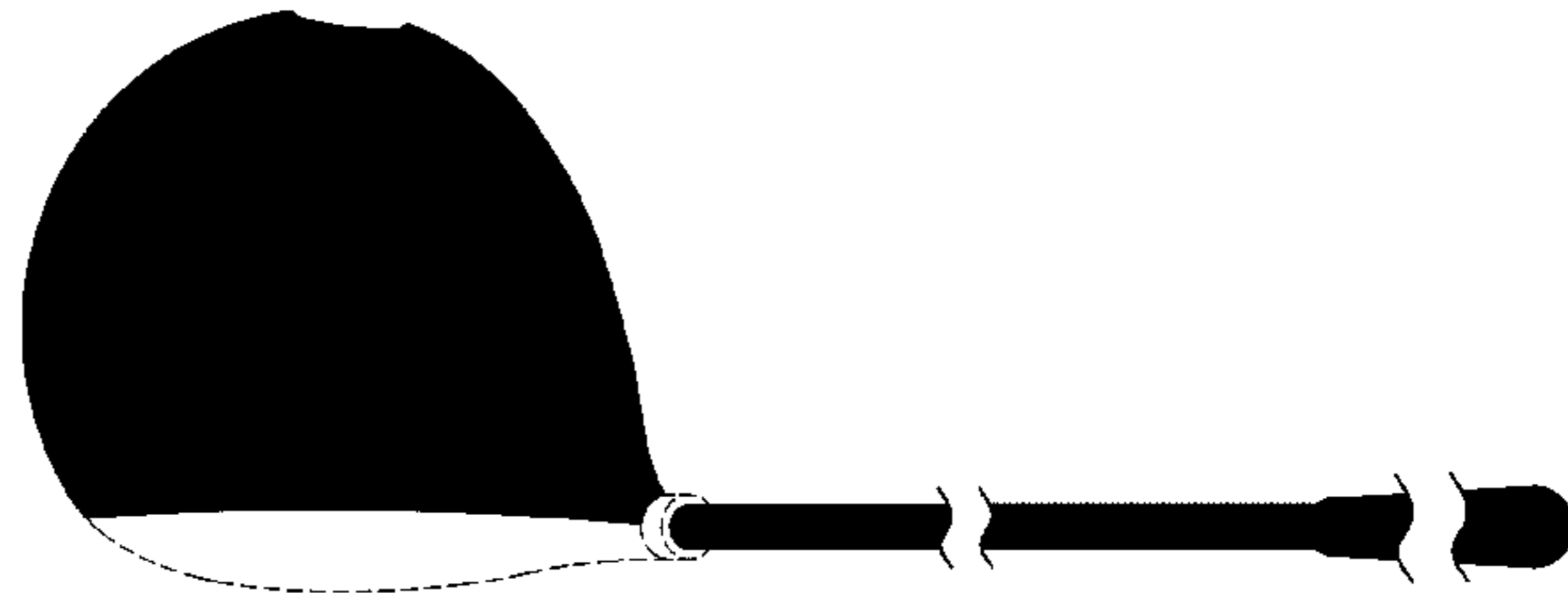
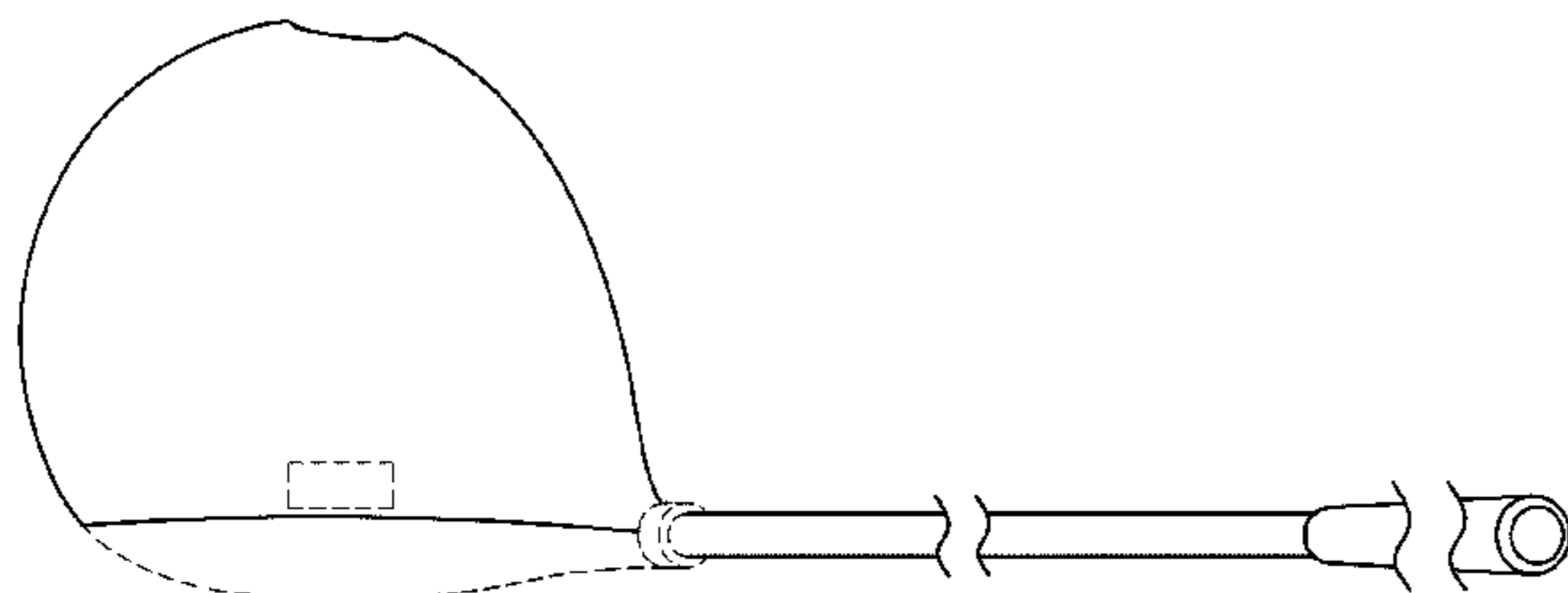

FIG. 14 is a front side view thereof; the drawing is lined for color, illustrating a white club grip, white shaft, and white club head crown;

FIG. 15 is a bottom, heel side perspective view of a golf club embodying our new design; the drawing is lined for color, illustrating a black club grip, black shaft, and black club head crown;

FIG. 16 is a heel side view thereof; the drawing is lined for color, illustrating a black club grip, black shaft, and black club head crown;

FIG. 17 is a toe side view thereof; the drawing is lined for color, illustrating a black club grip, black shaft, and black club head crown;

FIG. 18 is a back side view thereof; the drawing is lined for color, illustrating a black club grip, black shaft, and black club head crown;

FIG. 19 is a top side view thereof; the drawing is lined for color, illustrating a black club grip, black shaft, and black club head crown;

FIG. 20 is a bottom side view thereof; the drawing is lined for color, illustrating a black club grip, black shaft, and black club head crown;

FIG. 21 is a front side view thereof; the drawing is lined for color, illustrating a black club grip, black shaft, and black club head crown;

FIG. 22 is a bottom, heel side perspective view of a golf club embodying our new design; the drawing is lined for color, illustrating a black club grip, black shaft, and black club head crown;

FIG. 23 is a heel side view thereof; the drawing is lined for color, illustrating a black club grip, black shaft, and black club head crown;

FIG. 24 is a toe side view thereof; the drawing is lined for color, illustrating a black club grip, black shaft, and black club head crown;

FIG. 25 is a back side view thereof; the drawing is lined for color, illustrating a black club grip, black shaft, and black club head crown;

FIG. 26 is a top side view thereof; the drawing is lined for color, illustrating a black club grip, black shaft, and black club head crown;

FIG. 27 is a bottom side view thereof; the drawing is lined for color, illustrating a black club grip, black shaft, and black club head crown;

FIG. 28 is a front side view thereof; the drawing is lined for color, illustrating a black club grip, black shaft, and black club head crown; and,

FIG. 29 is a bottom side view of a golf club embodying our new design.

All features illustrated in phantom line are expressly disclaimed and form no part of the claimed design.

1 Claim, 29 Drawing Sheets

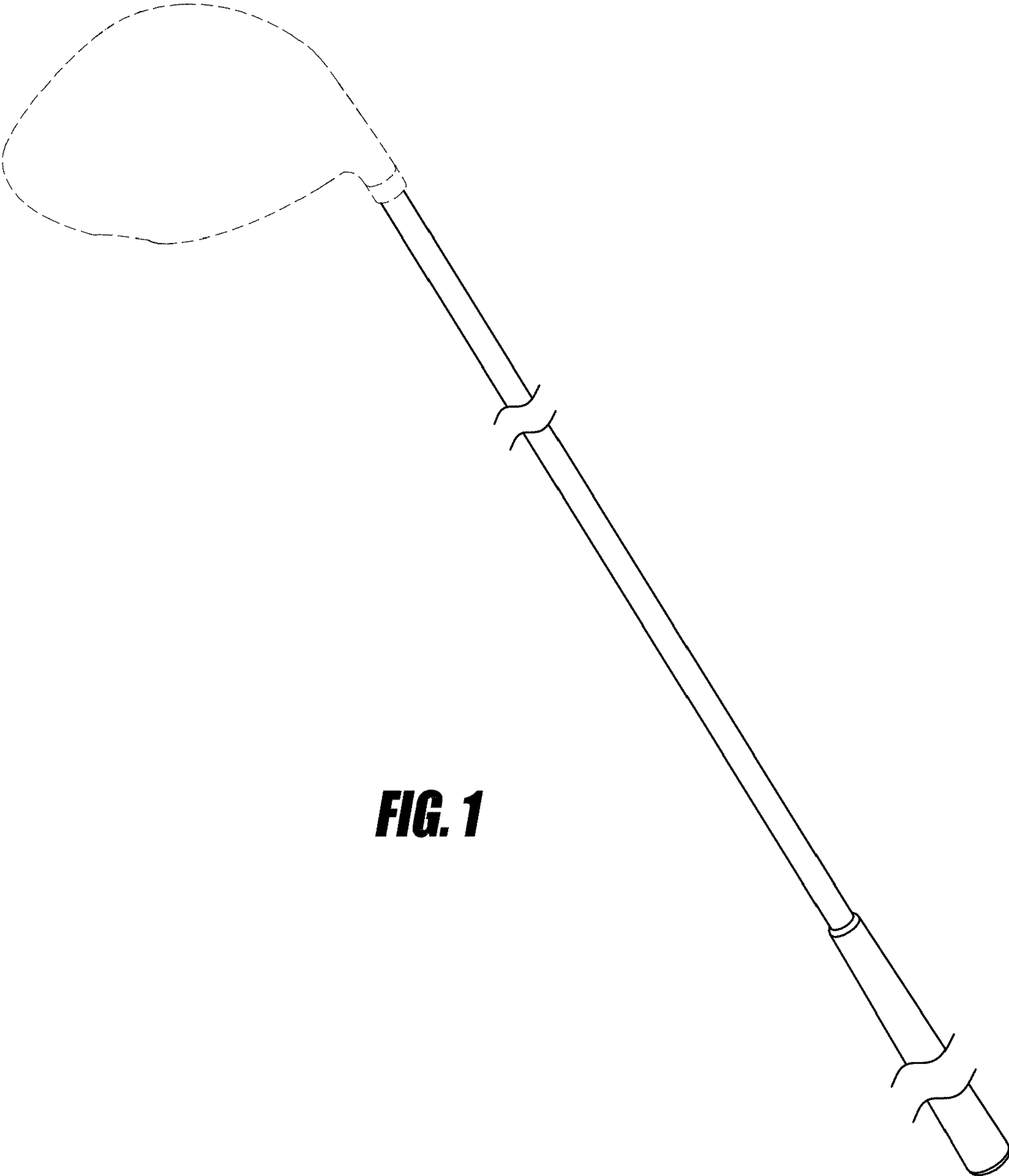

FIG. 1

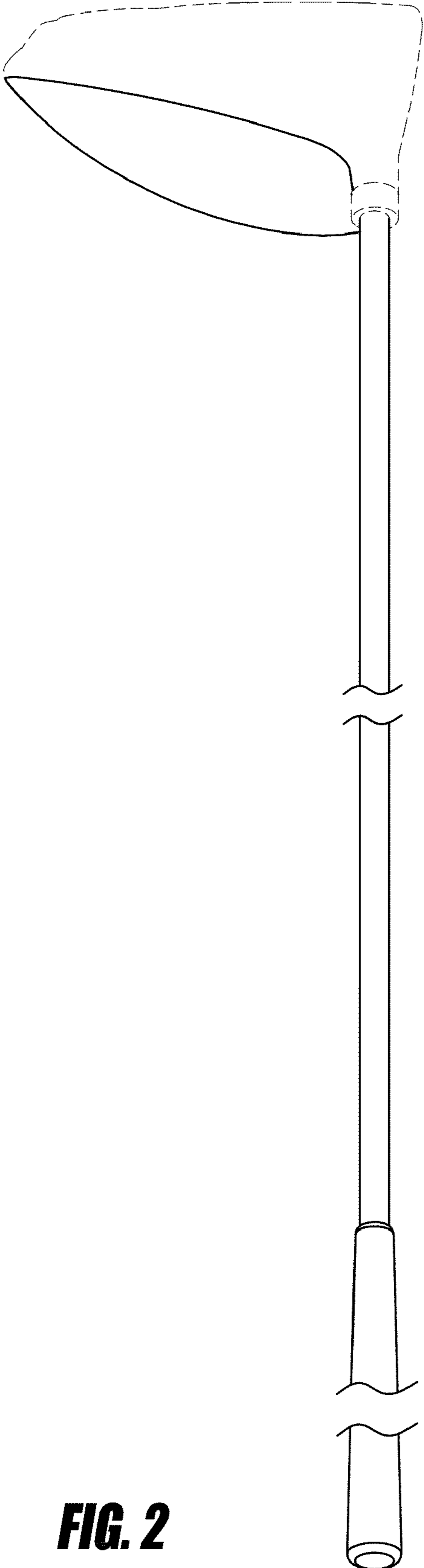

FIG. 2

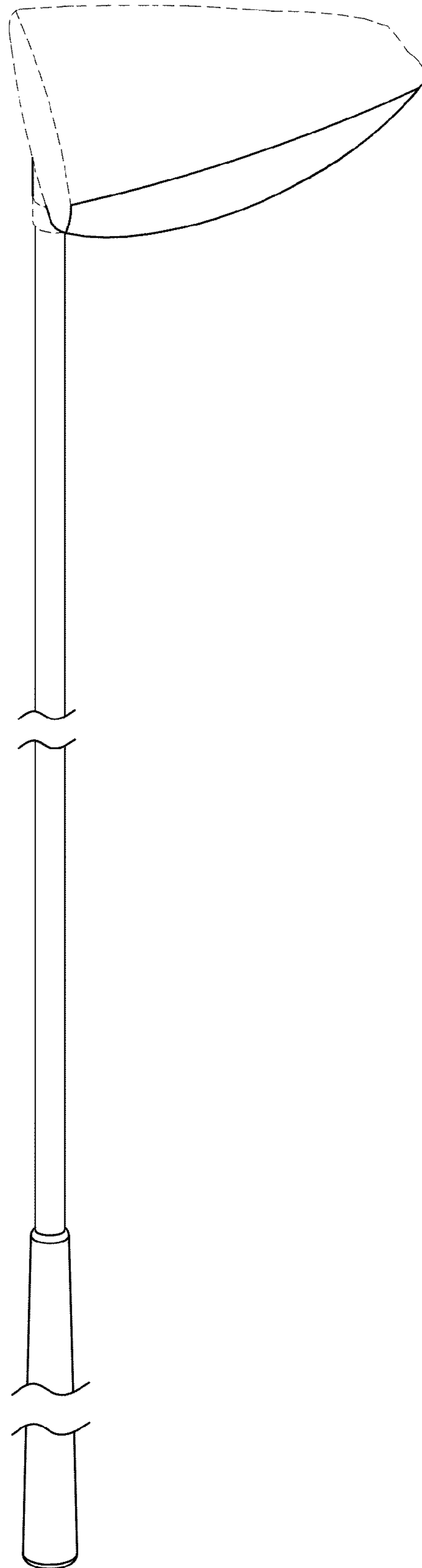

FIG. 3

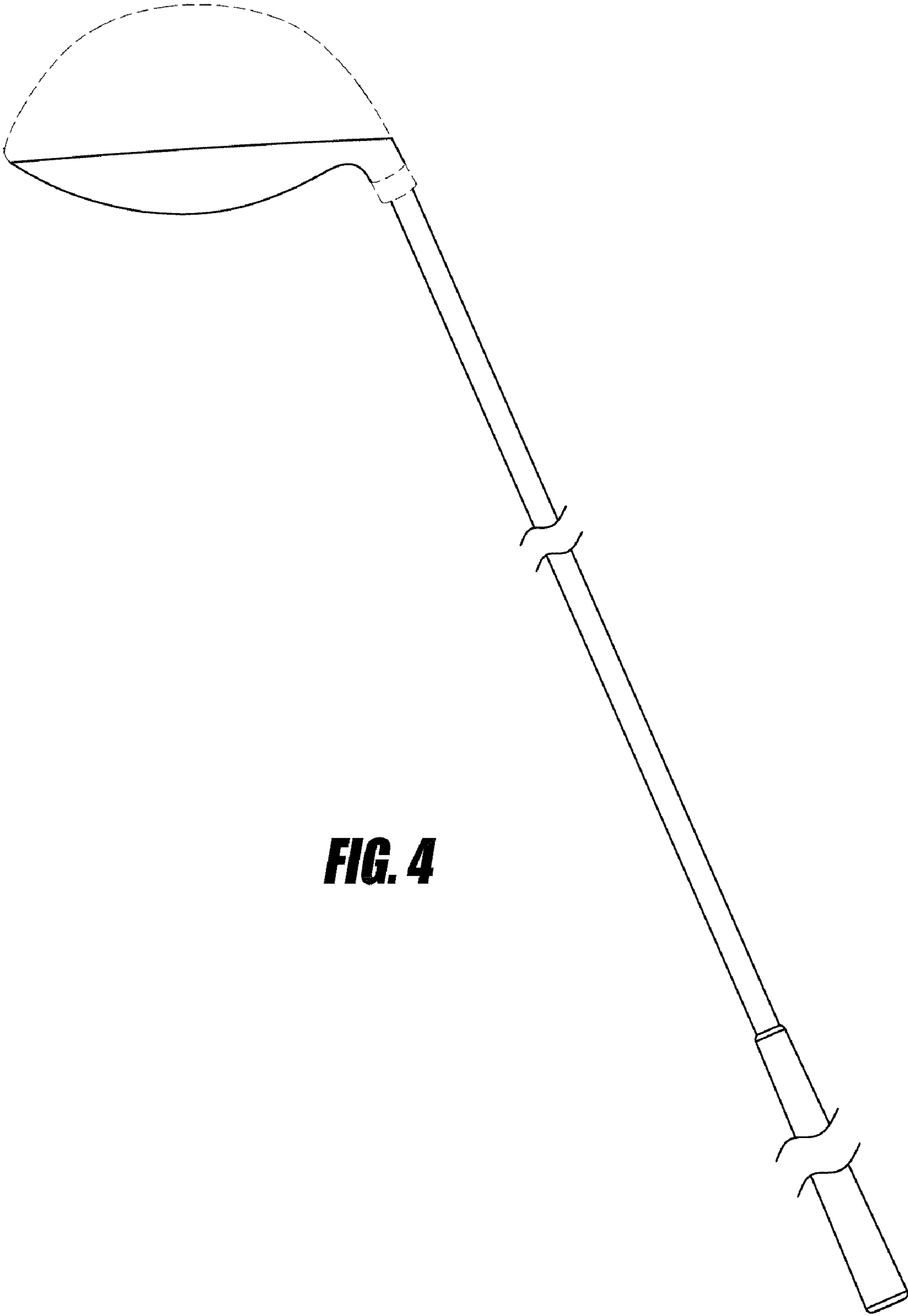

FIG. 4

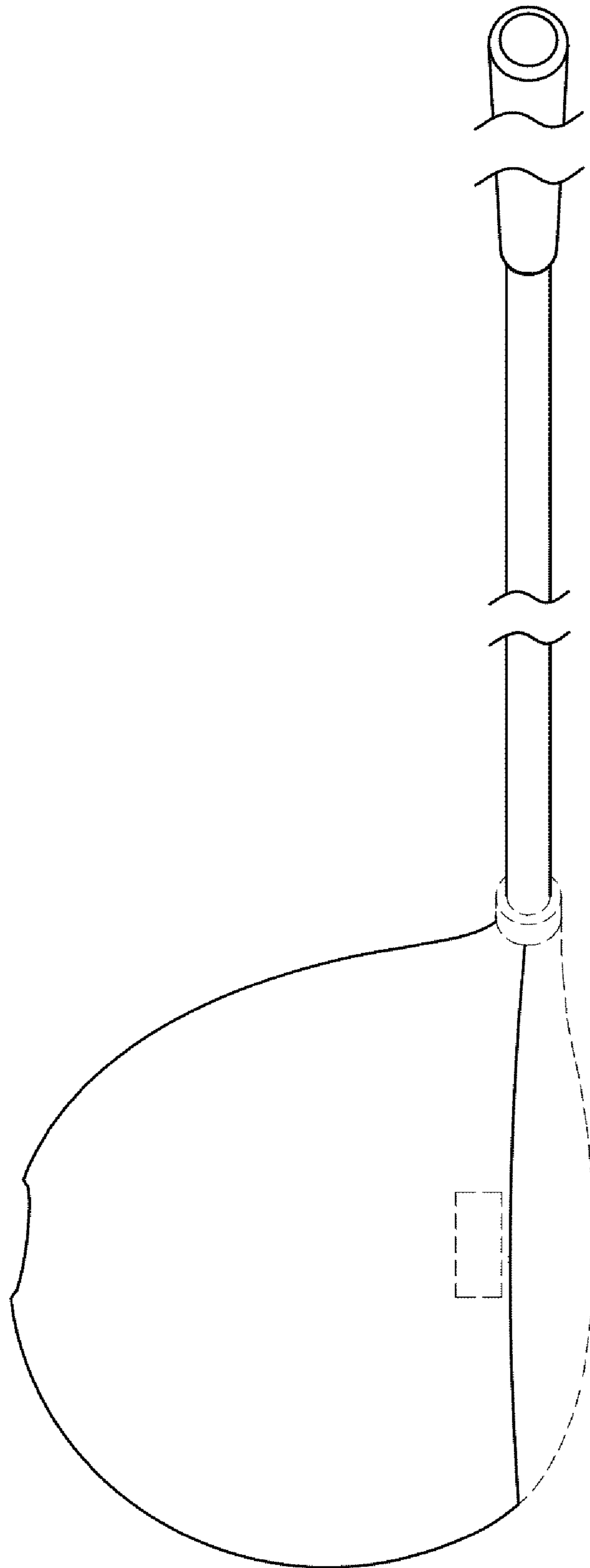

FIG. 5

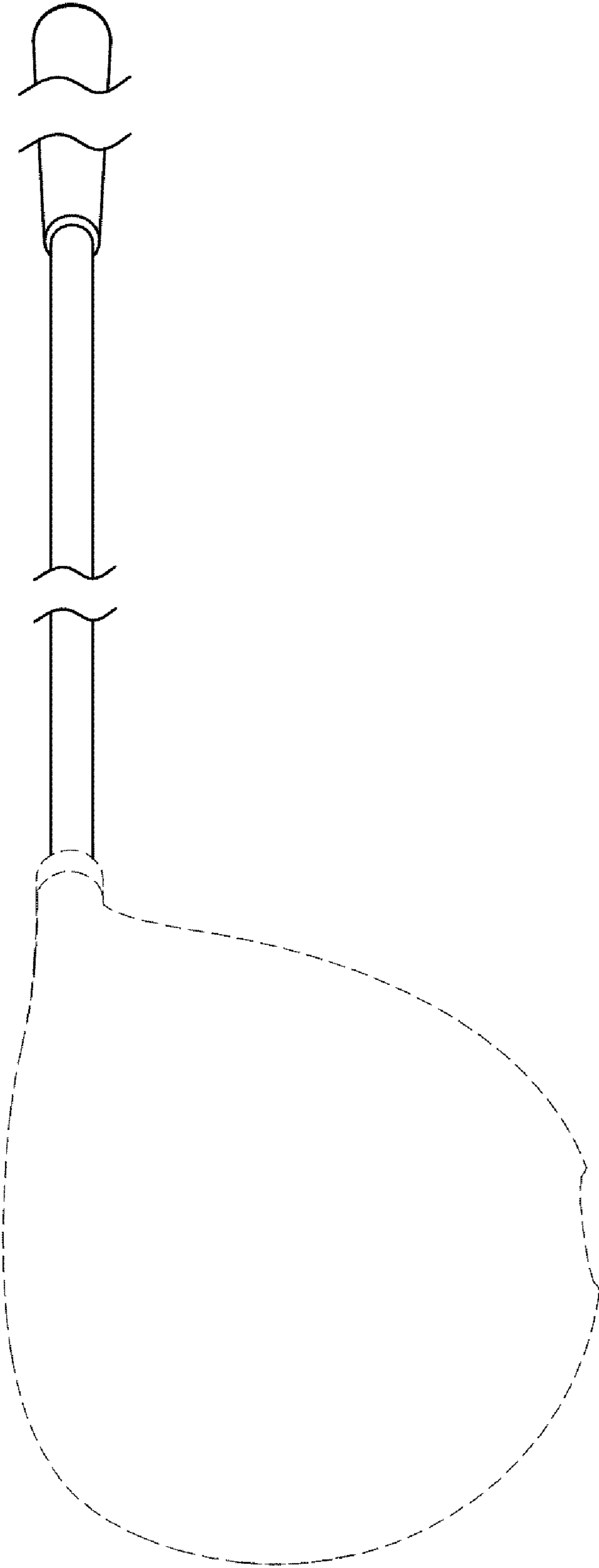

FIG. 6

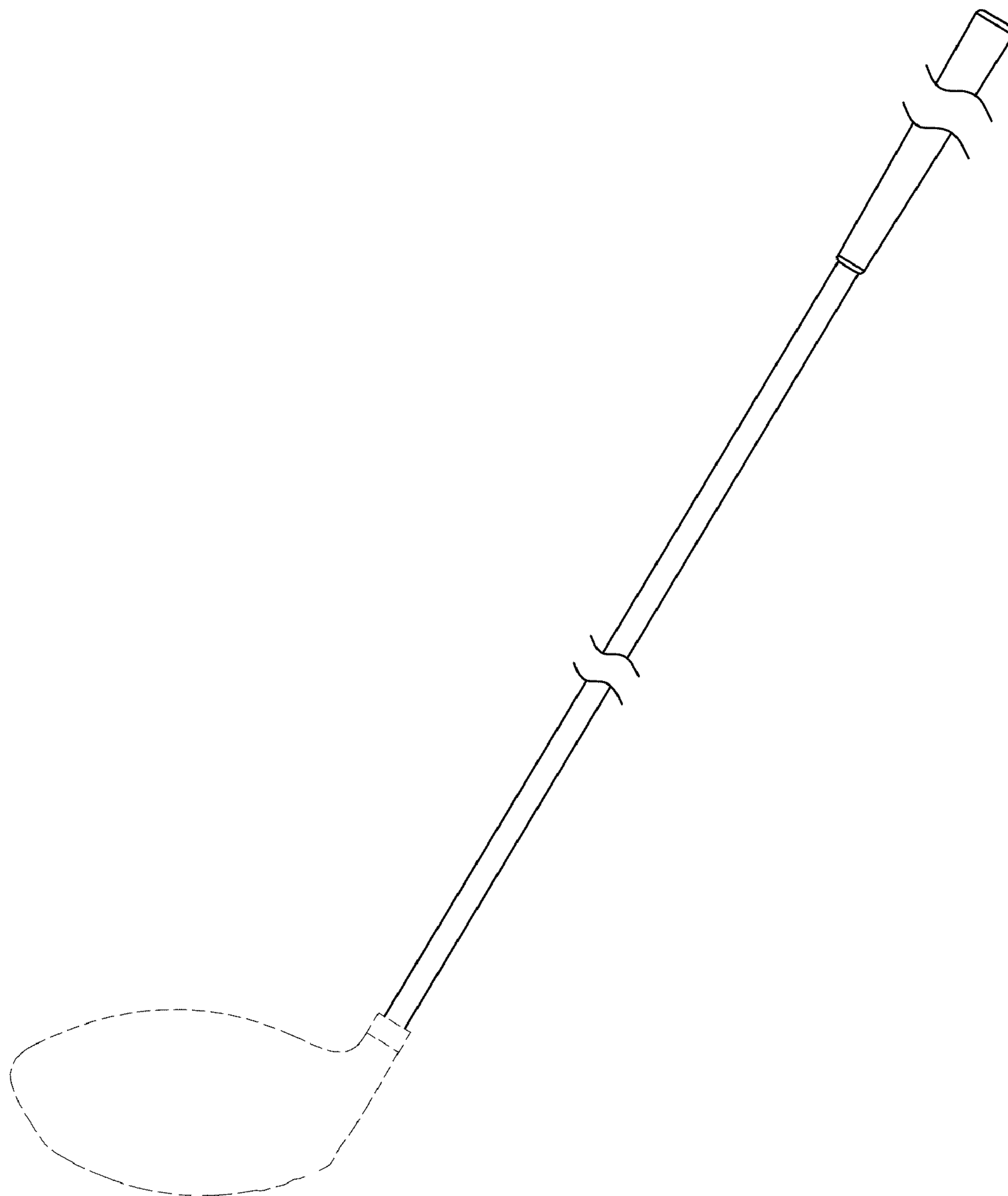

FIG. 7

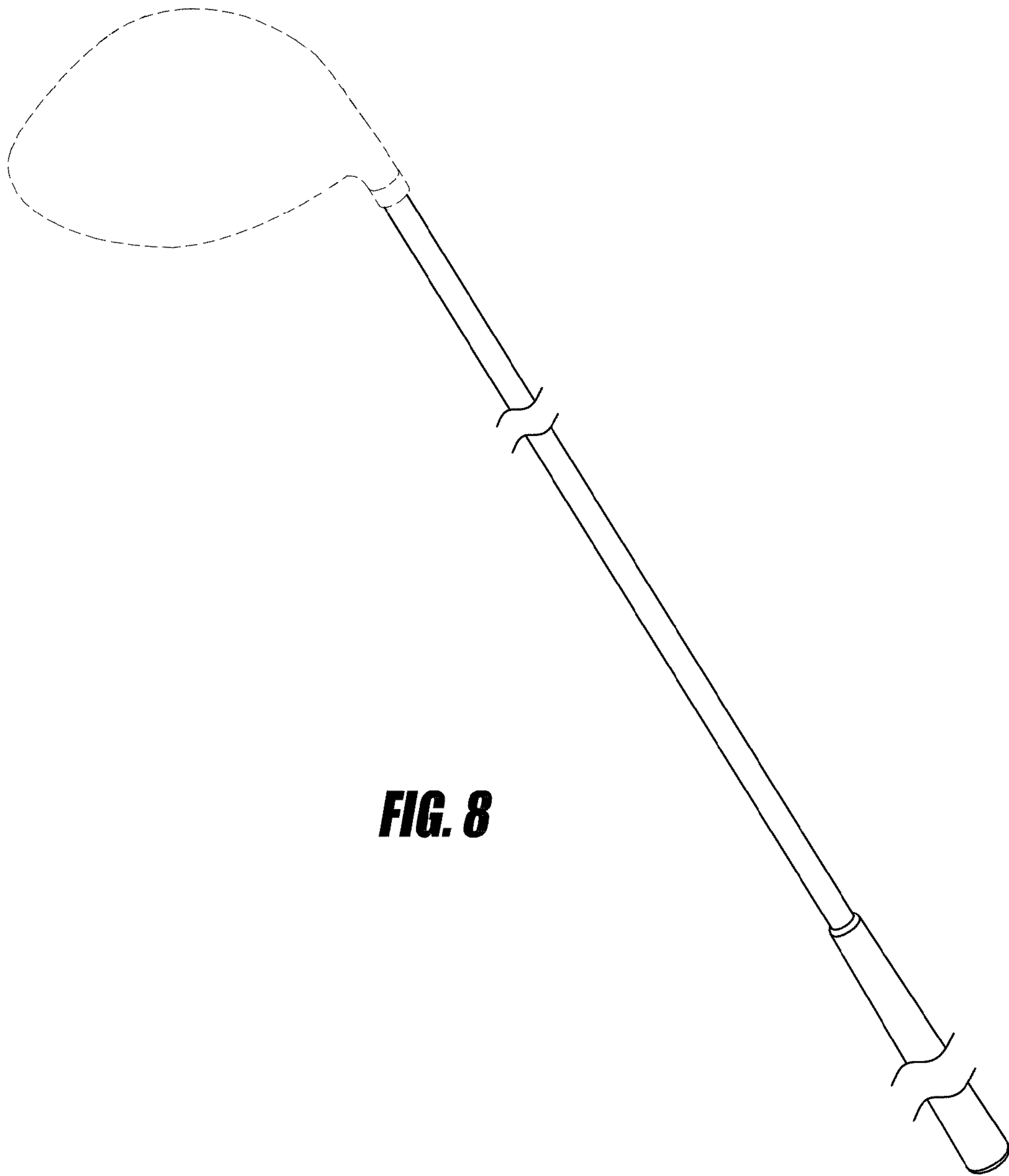

FIG. 8

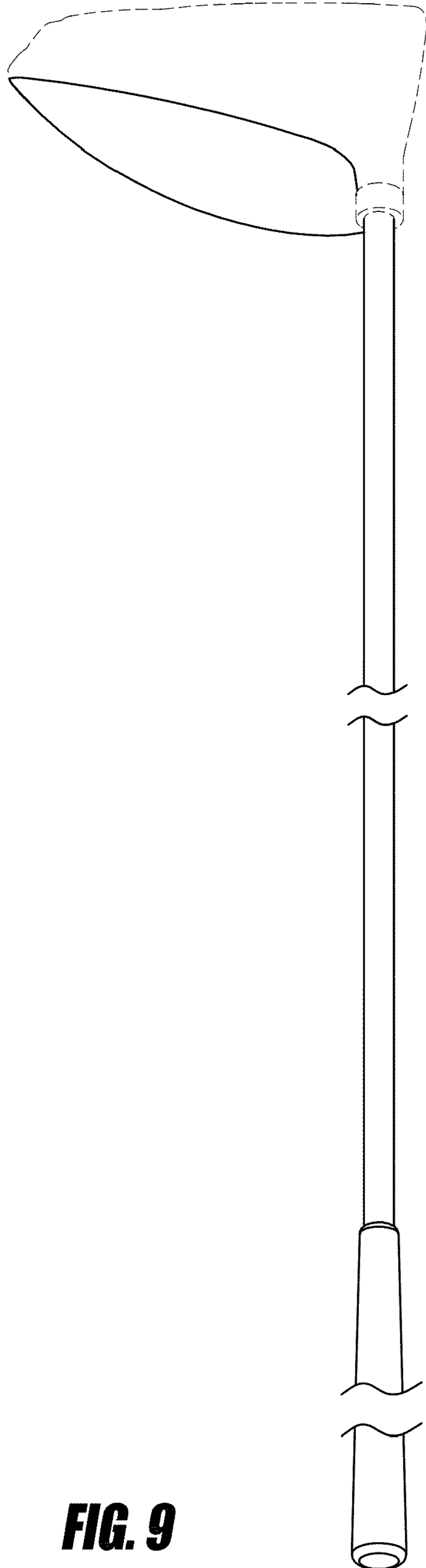

FIG. 9

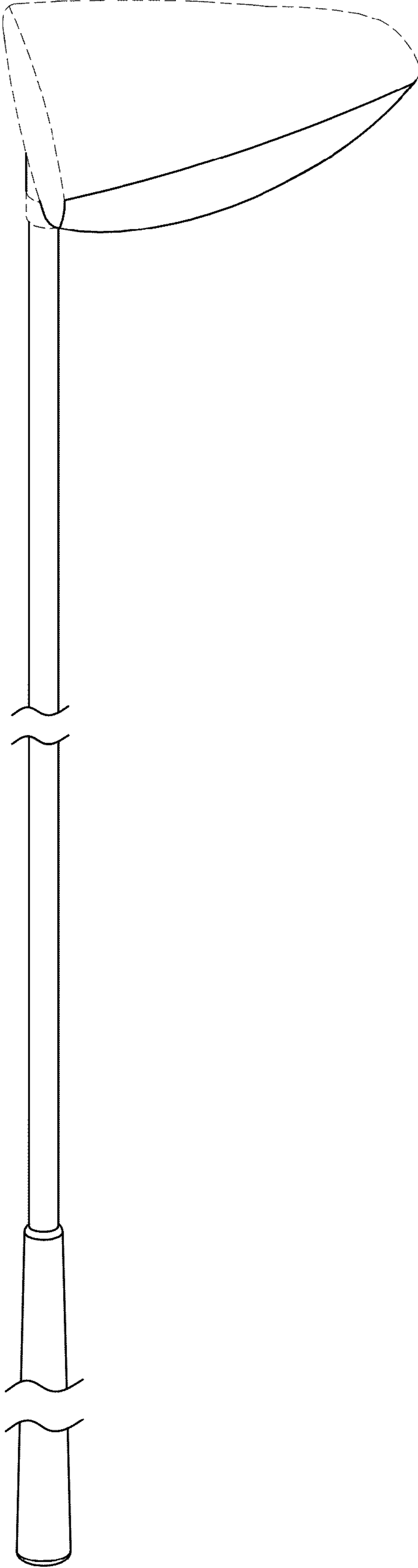

FIG. 10

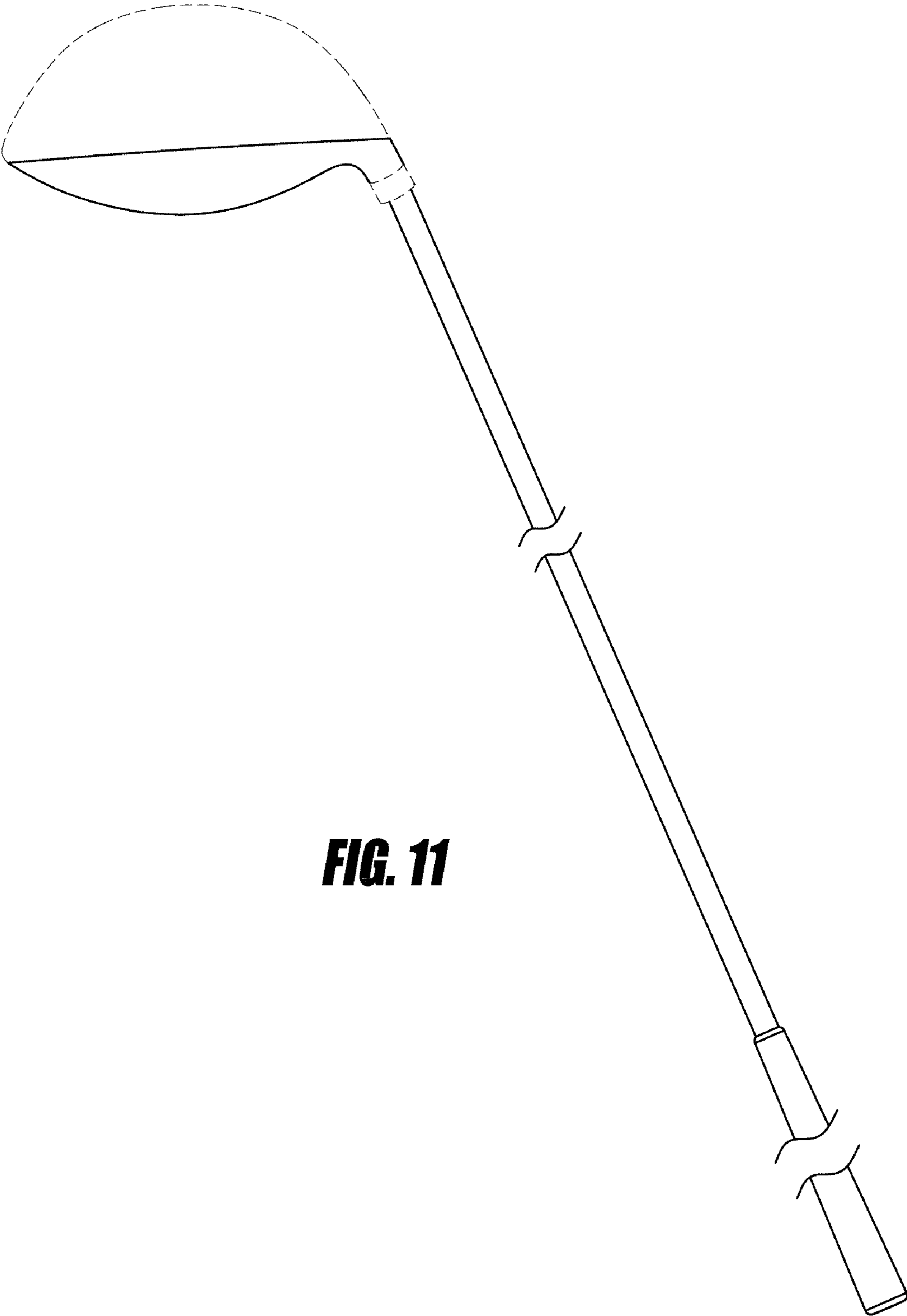

FIG. 11

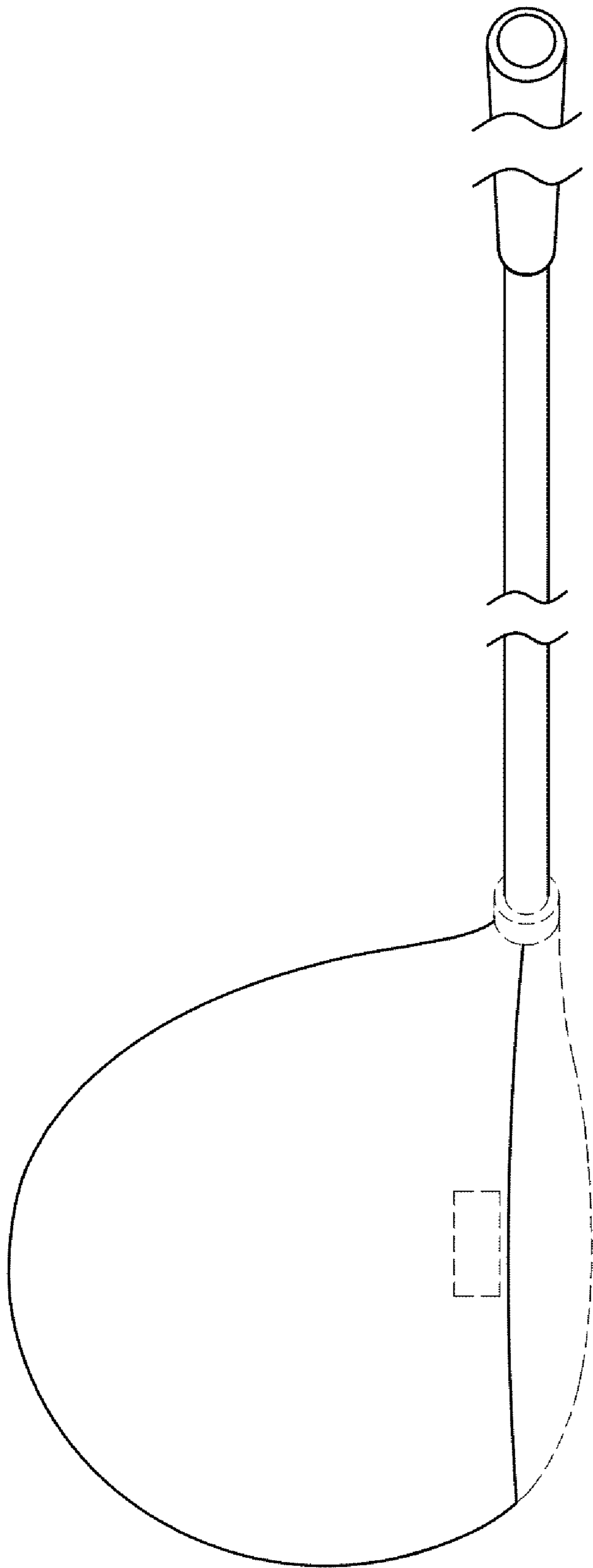

FIG. 12

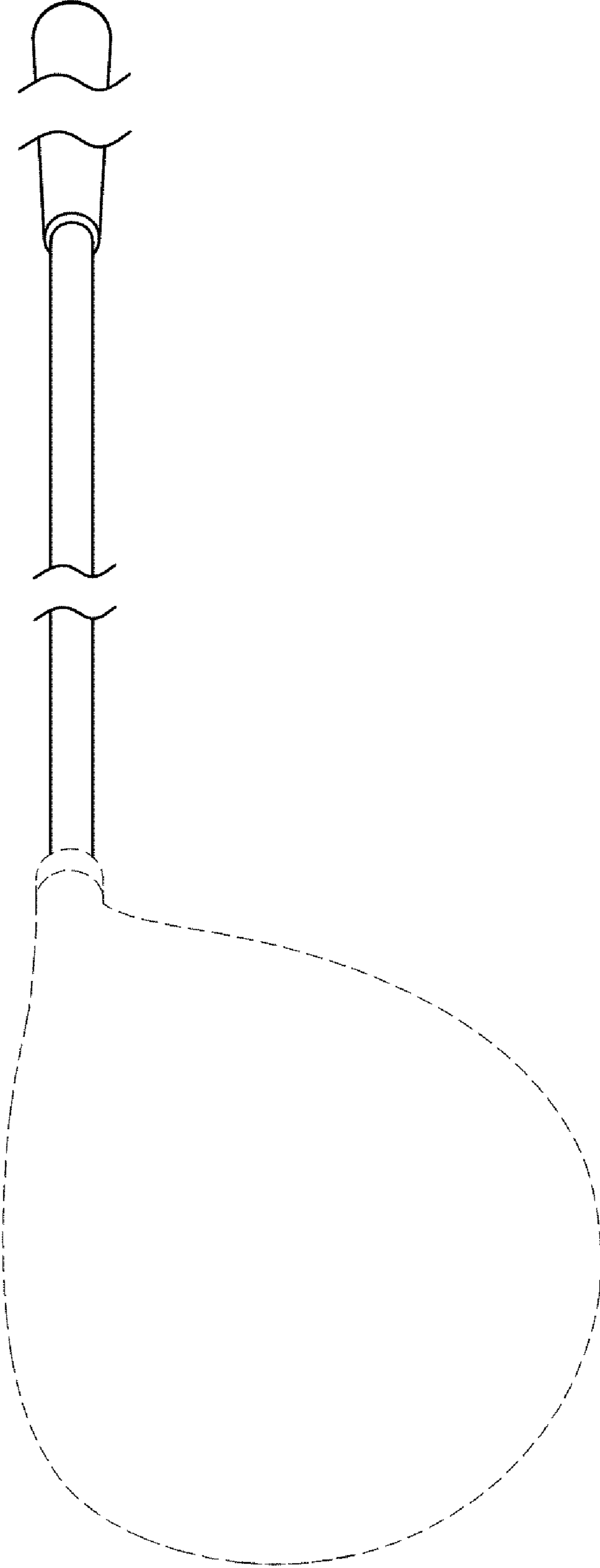

FIG. 13

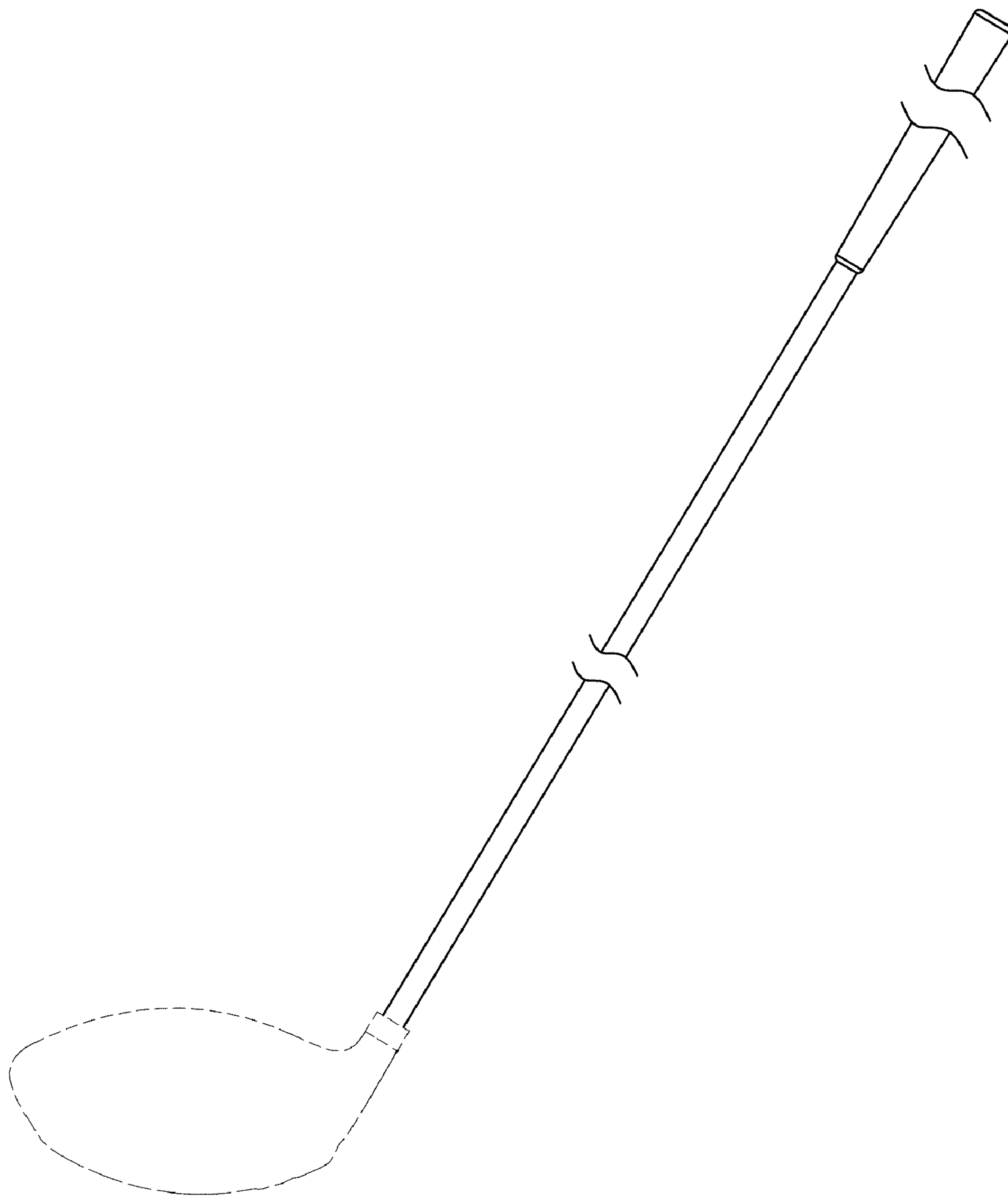

FIG. 14

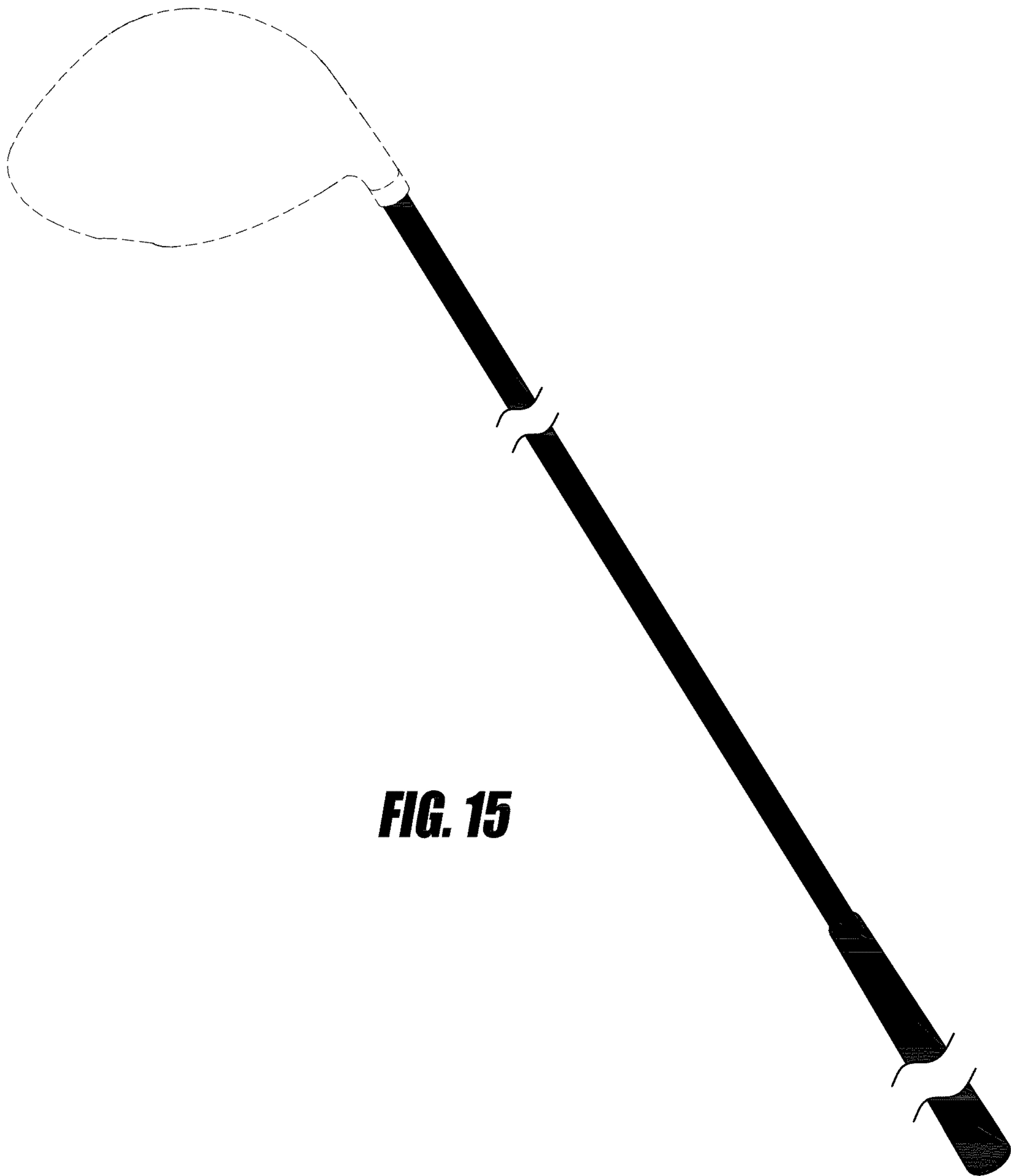

FIG. 15

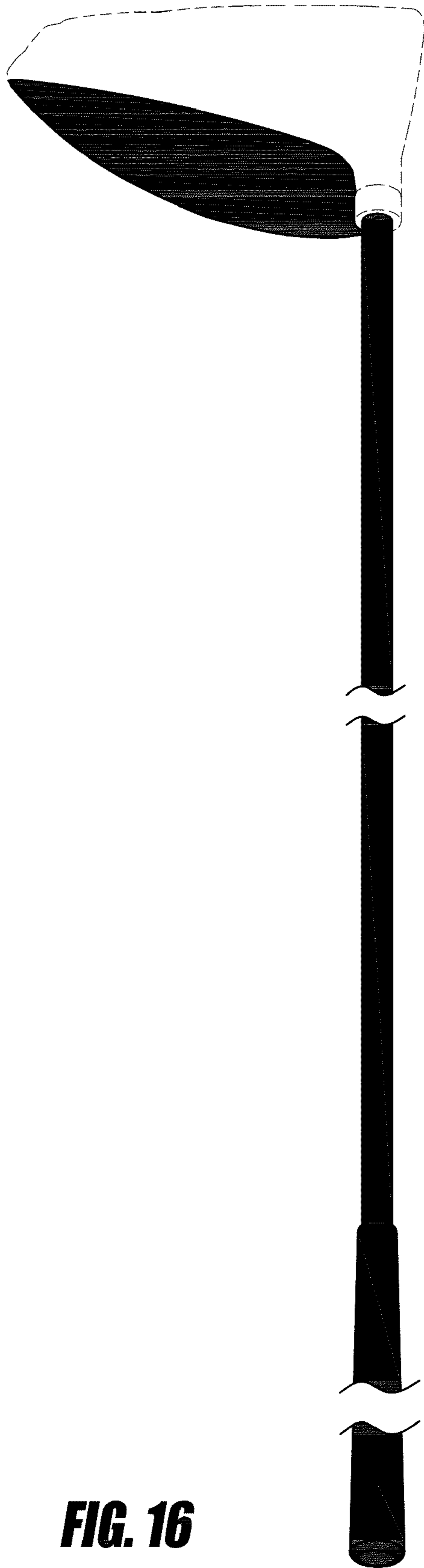

FIG. 16

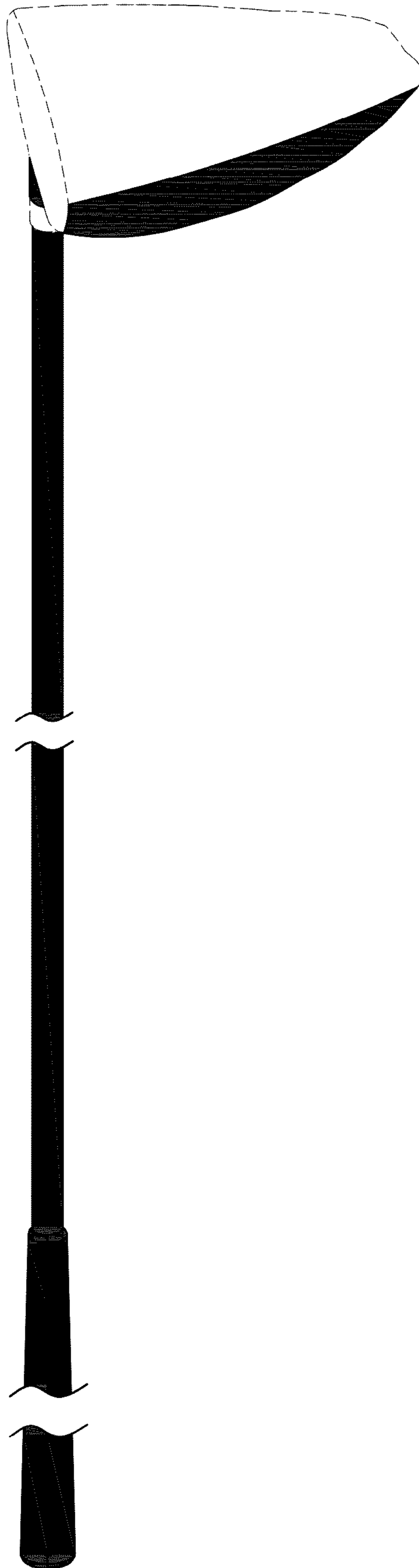

FIG. 17

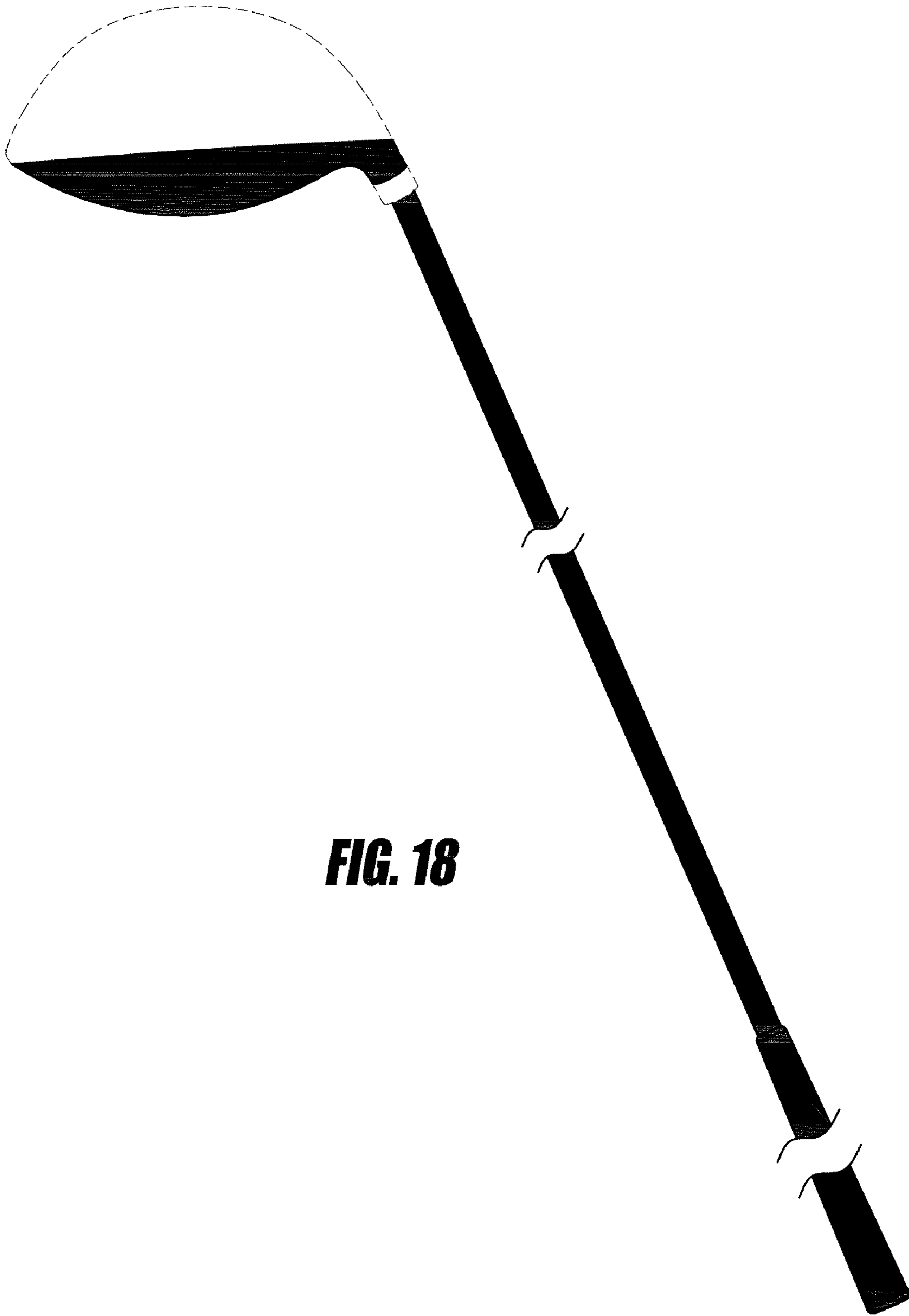

FIG. 18

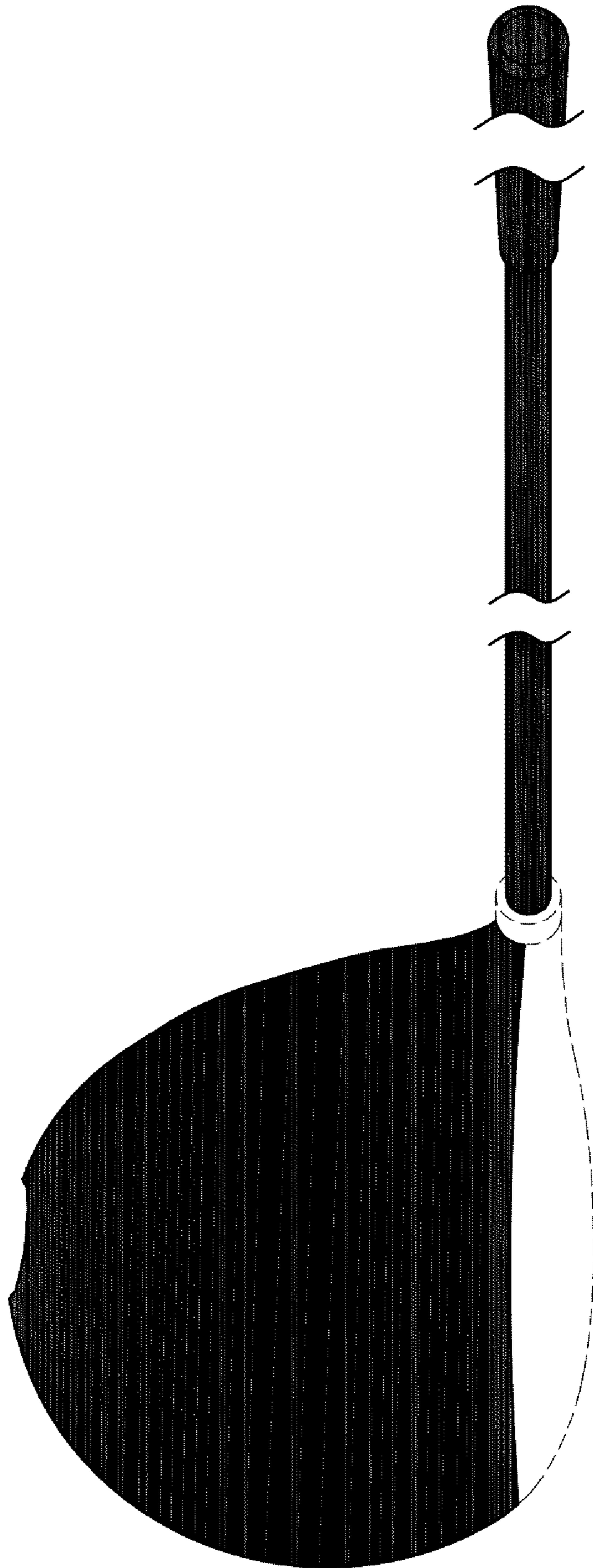

FIG. 19

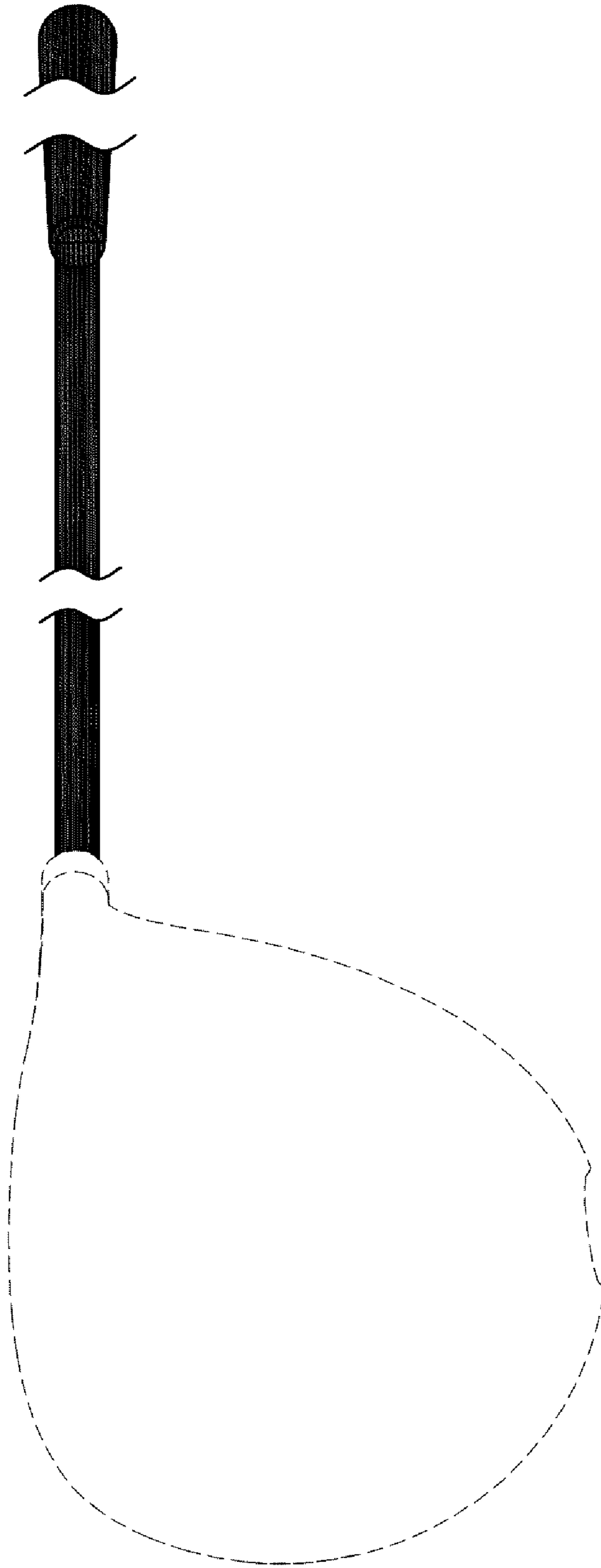

FIG. 20

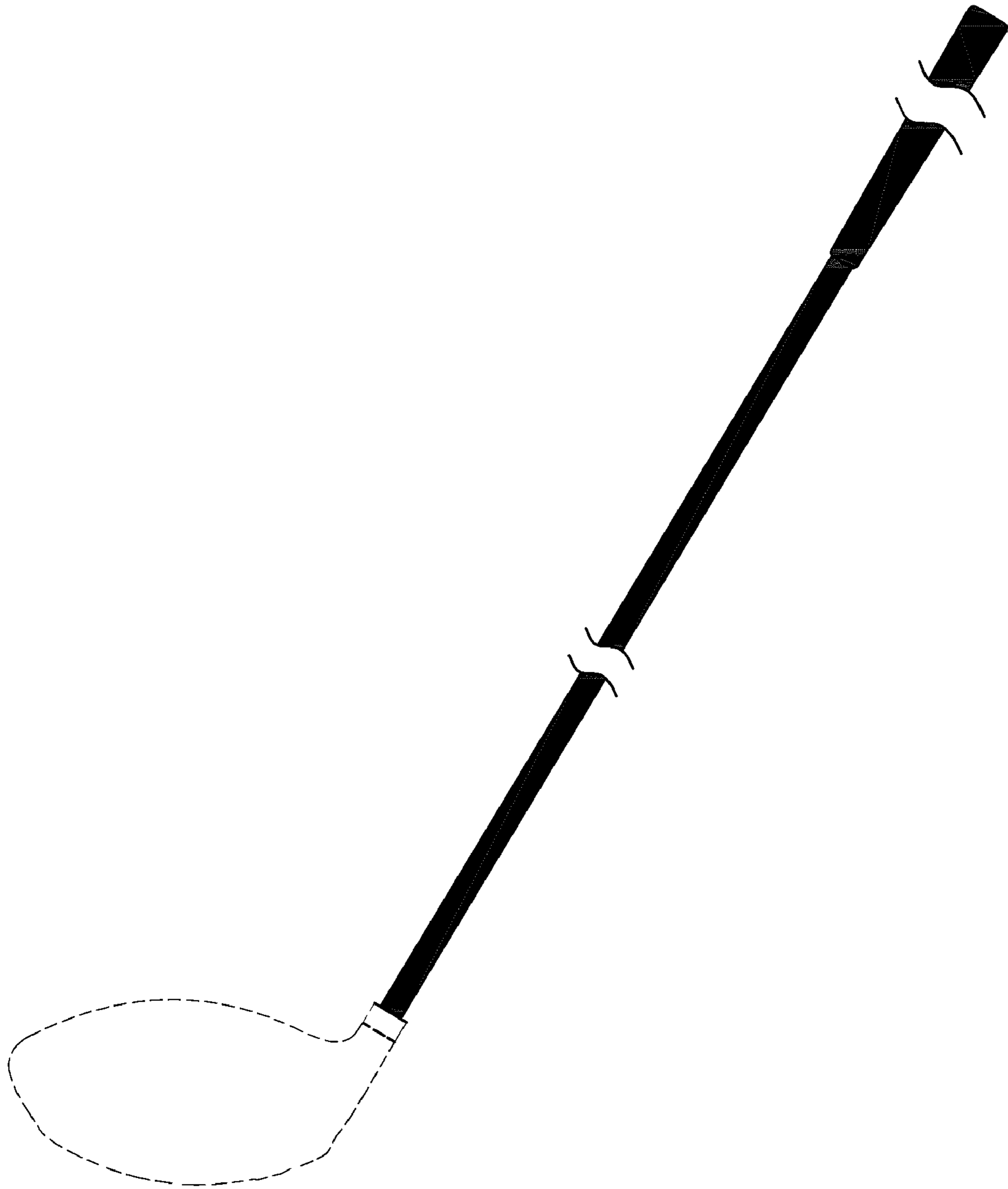

FIG. 21

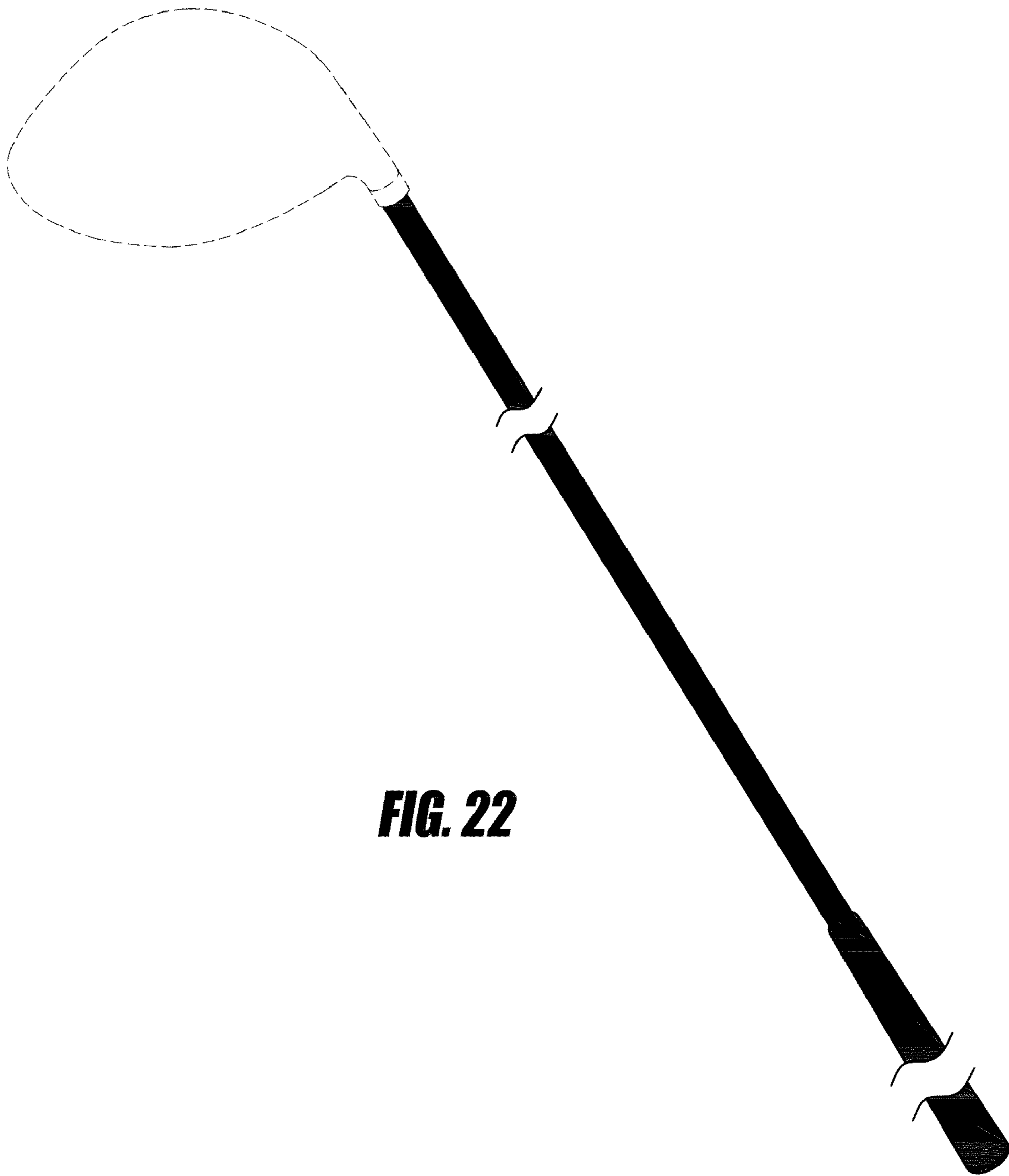

FIG. 22

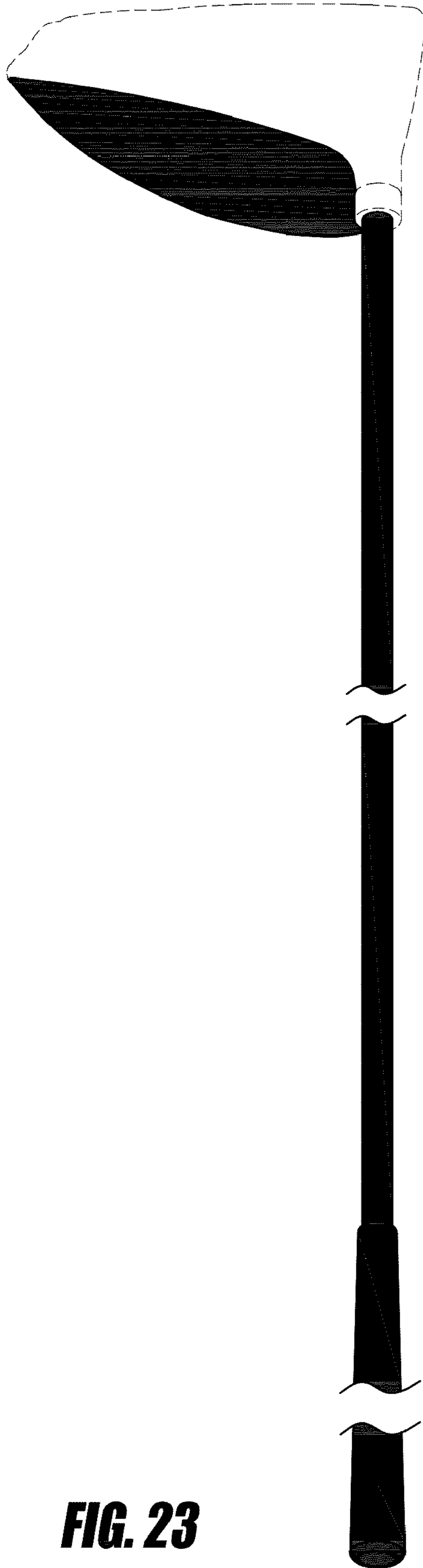

FIG. 23

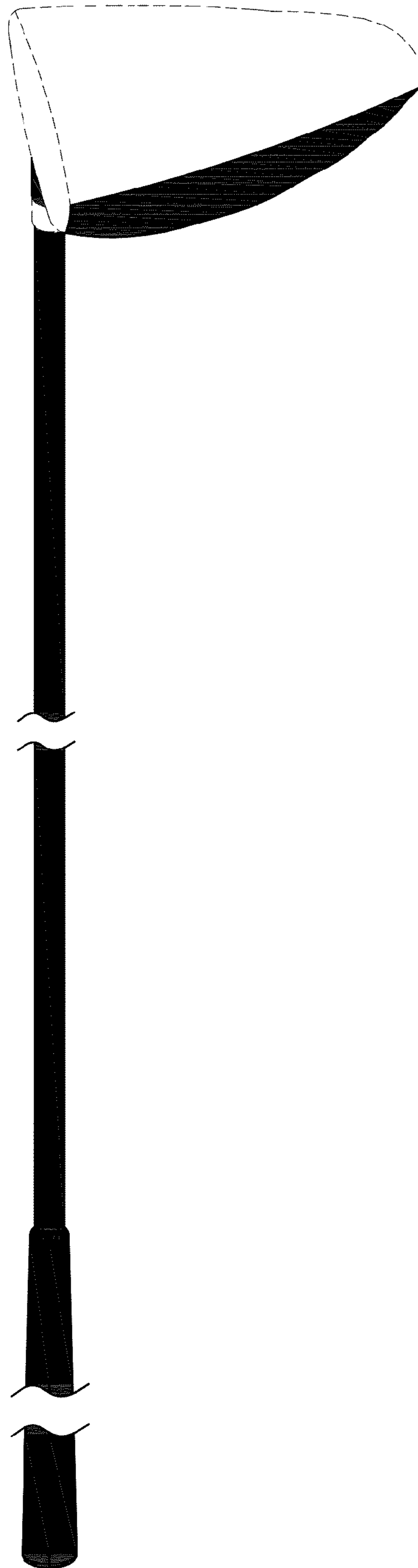

FIG. 24

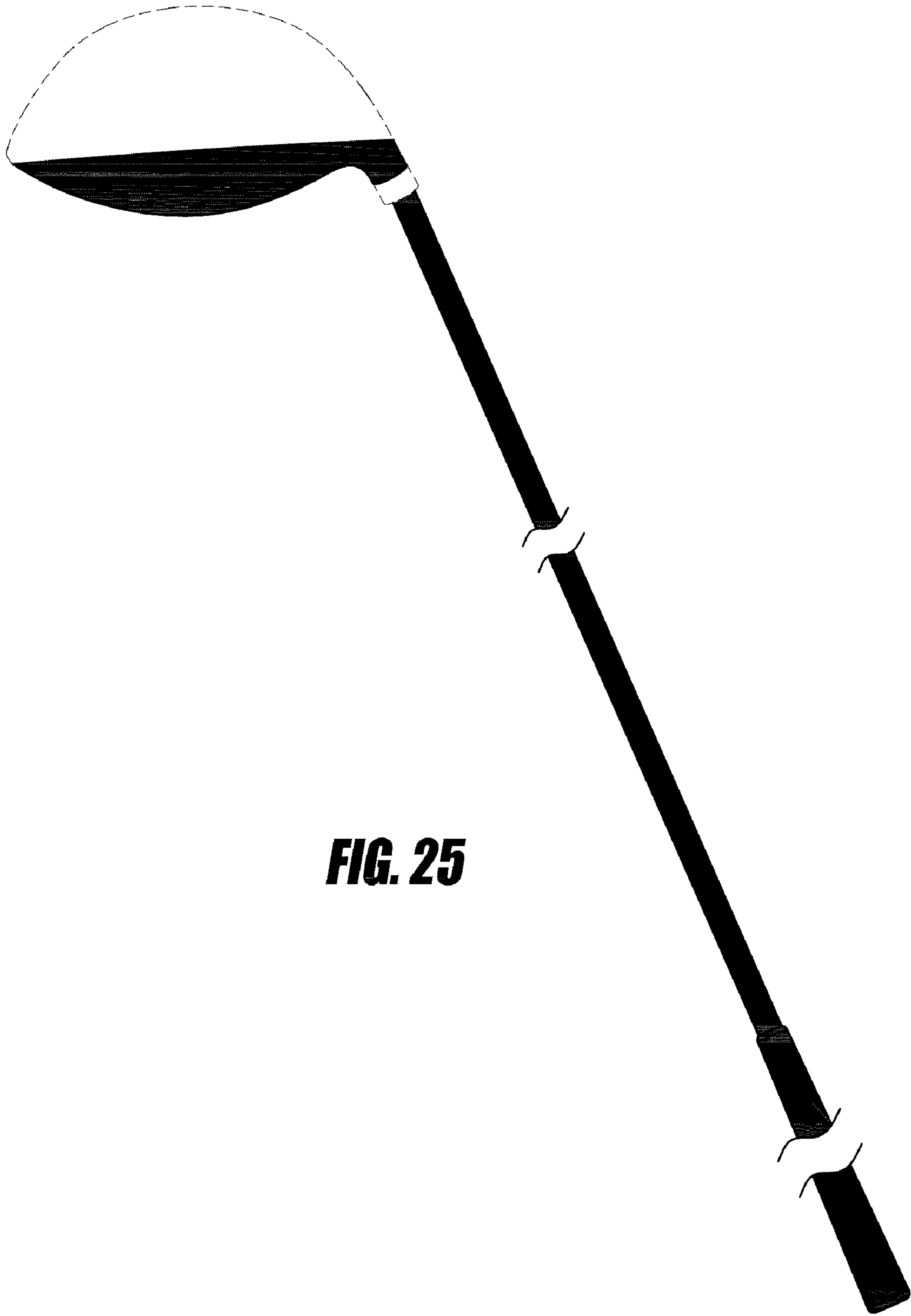

FIG. 25

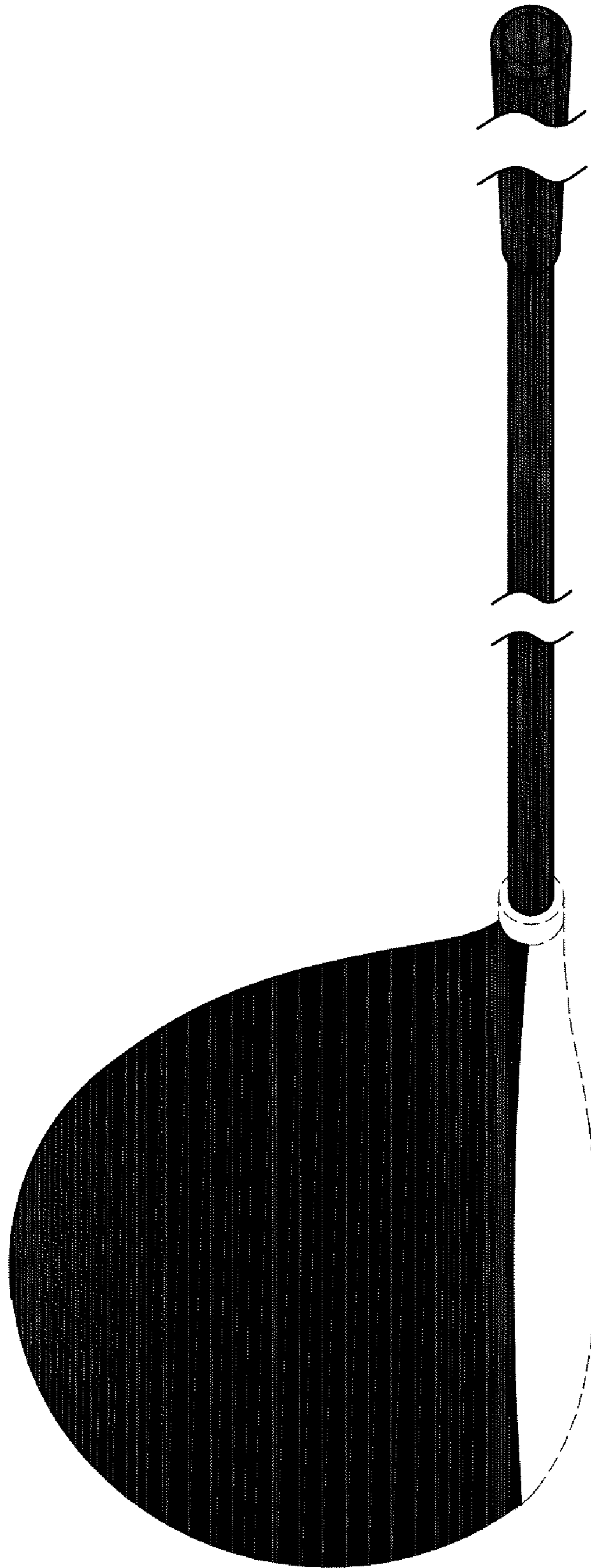

FIG. 26

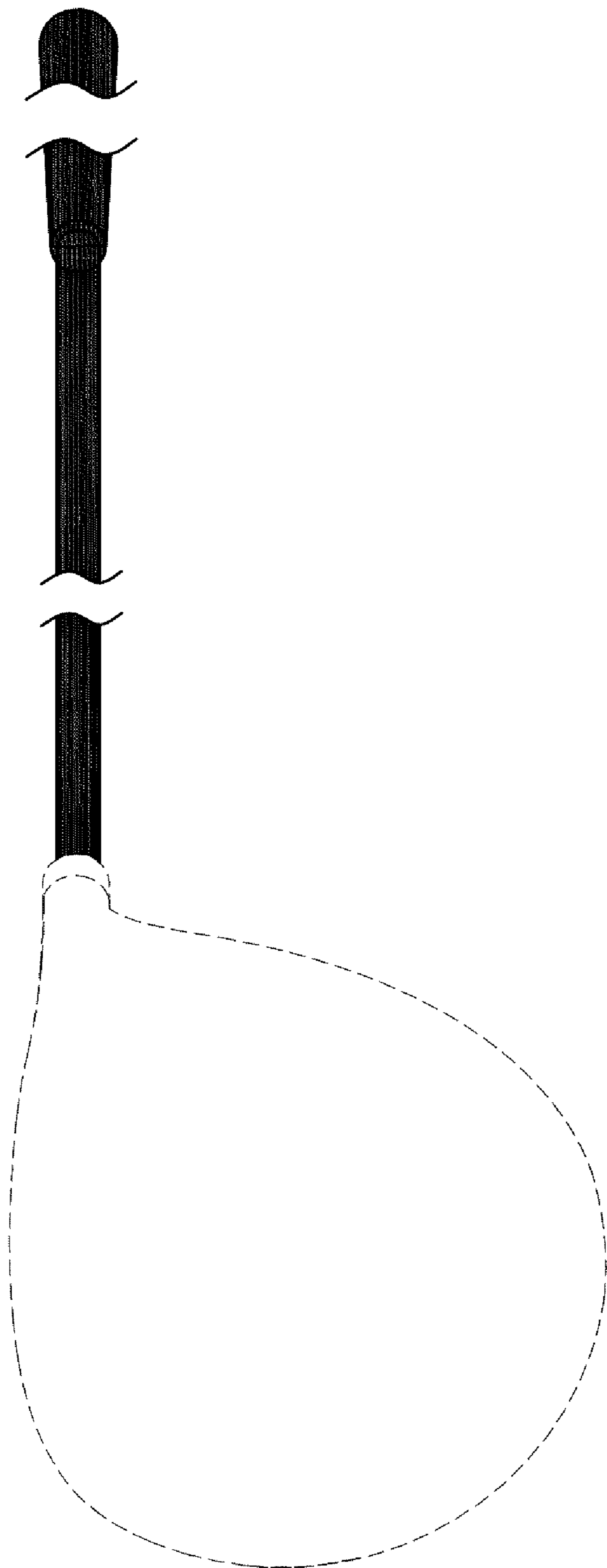

FIG. 27

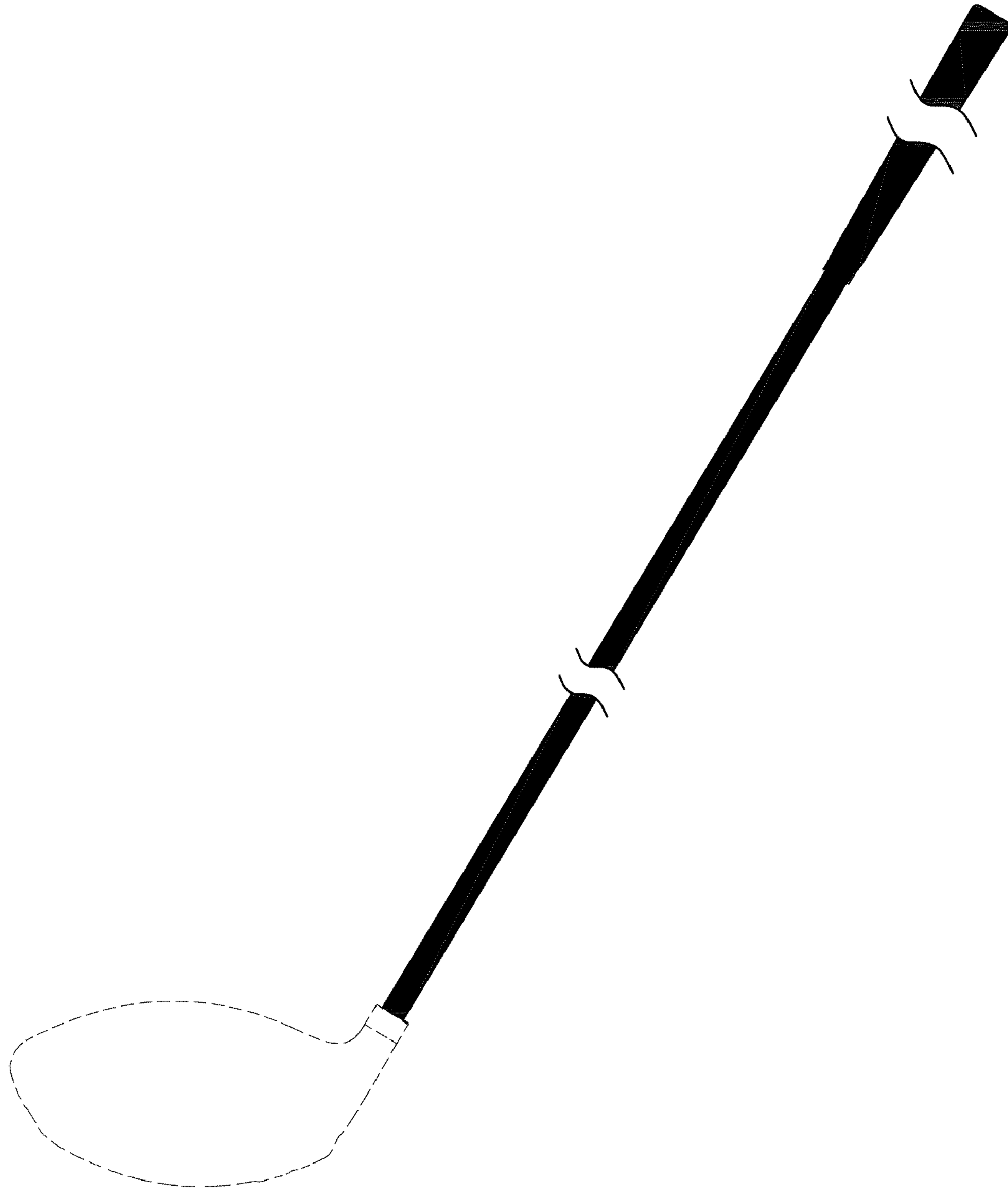

FIG. 28

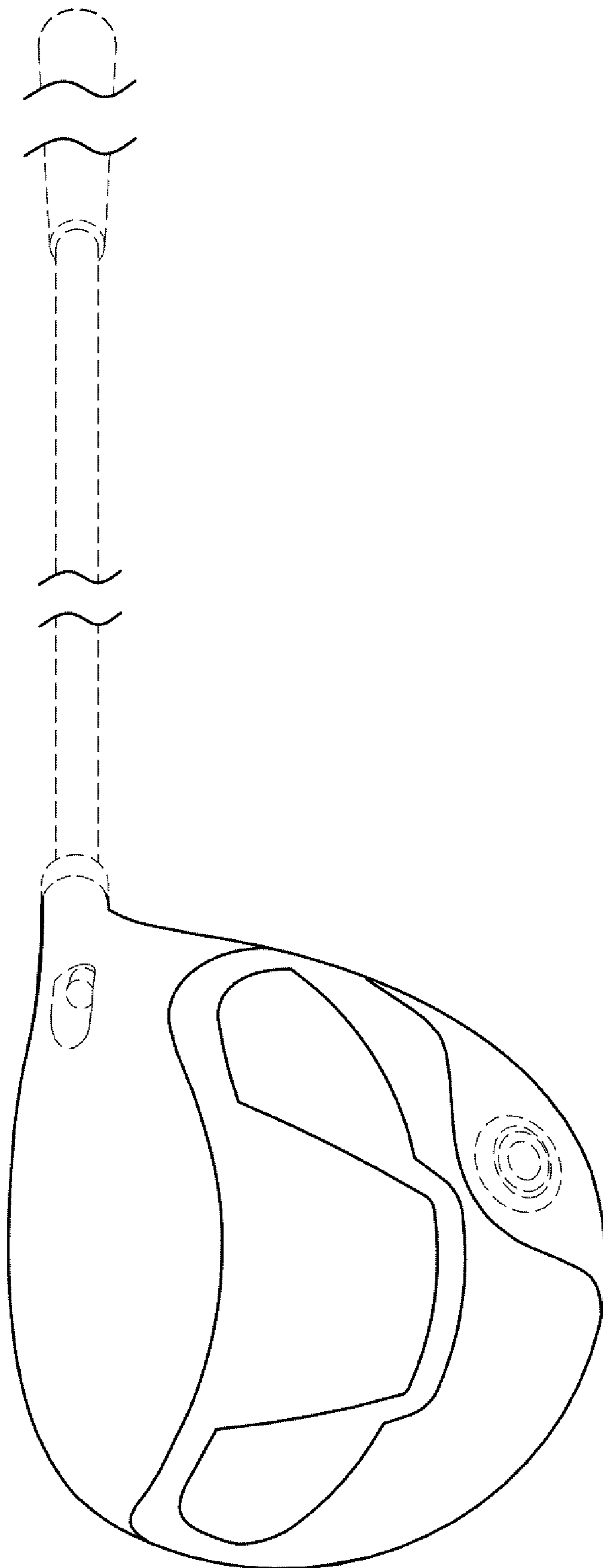

FIG. 29