



US00D652452S

(12) **United States Design Patent**
Casciotti et al.

(10) **Patent No.:** **US D652,452 S**
(45) **Date of Patent:** **** Jan. 17, 2012**

(54) **WRITING INSTRUMENT**

(75) Inventors: **David M Casciotti**, Amsterdam, NY (US); **Joseph E Achzet**, Gloversville, NY (US); **Jing Mahler**, Glenville, NY (US)

(73) Assignee: **Holland USA, Inc.**, North Mankato, MN (US)

(**) Term: **14 Years**

(21) Appl. No.: **29/384,437**

(22) Filed: **Jan. 31, 2011**

(51) **LOC (9) Cl.** **19-06**

(52) **U.S. Cl.** **D19/54**

(58) **Field of Classification Search** D19/35,
D19/36, 41-51, 54-58; D14/411, 431; 24/11 R,
24/11 F, 11 P; 401/52, 99, 100, 104-109,
401/192, 195, 196

See application file for complete search history.

(56) **References Cited**

U.S. PATENT DOCUMENTS

D409,661 S *	5/1999	Izushima	D19/57
D426,572 S *	6/2000	Salemme et al.	D19/47
D488,507 S *	4/2004	Finney et al.	D19/51
D509,853 S *	9/2005	Anand	D19/51
D563,473 S *	3/2008	Qiu et al.	D19/50
D568,402 S *	5/2008	Mori	D19/84
D573,186 S *	7/2008	Rommel	D19/51
D585,938 S *	2/2009	Feng et al.	D19/50
D600,282 S *	9/2009	Guoguang	D19/50

D602,087 S *	10/2009	Rommel	D19/50
D611,099 S *	3/2010	Jin	D19/54
D620,525 S *	7/2010	Rommel	D19/55
D631,913 S *	2/2011	Li	D19/48

* cited by examiner

Primary Examiner — Elizabeth Albert

(74) *Attorney, Agent, or Firm* — Dicke, Billig & Czaja PLLC

(57) **CLAIM**

We claim the ornamental design for a writing instrument, as shown and described.

DESCRIPTION

FIG. 1 is a top perspective view of a writing instrument showing our new design;

FIG. 2 is a front view of the same writing instrument;

FIG. 3 is a back view of the same writing instrument;

FIG. 4 is a left side view of the same writing instrument, the right side view being a mirror image of the left side view;

FIG. 5 is an enlarged top view of the same writing instrument; and,

FIG. 6 is an enlarged bottom view of the same writing instrument.

The broken lines shown in the drawings illustrate features of the article to which the design is applied that form no part of the claim.

The stippling represents contrast in material.

1 Claim, 4 Drawing Sheets

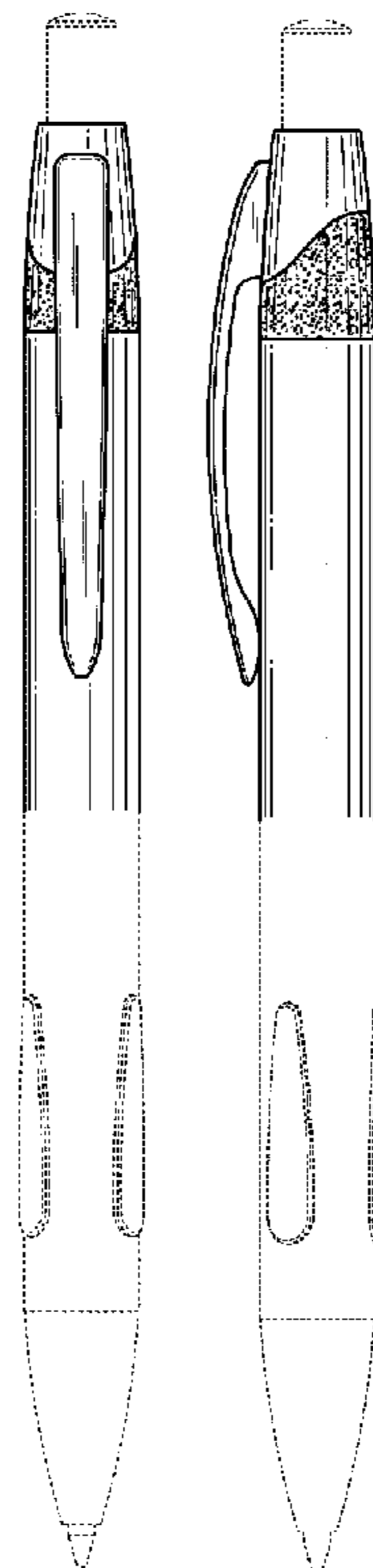

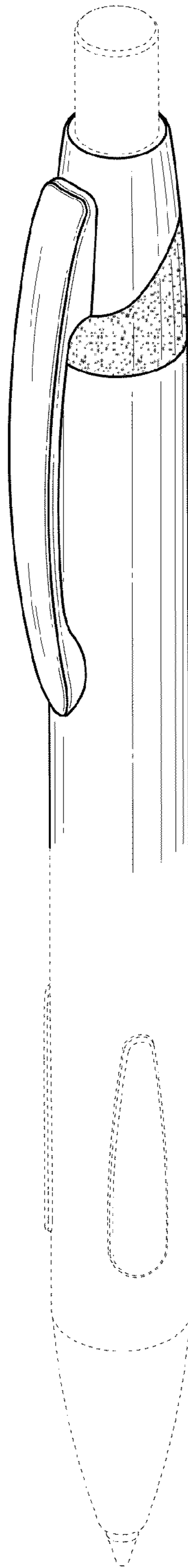

Fig. 1

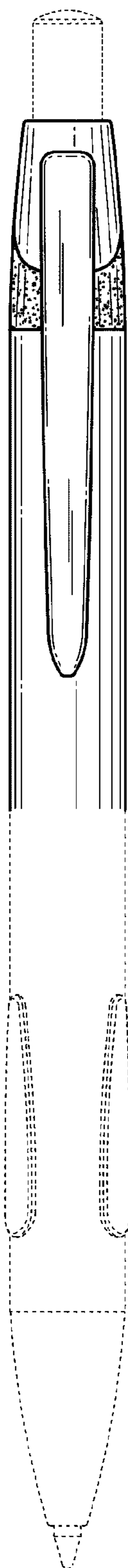

Fig. 2

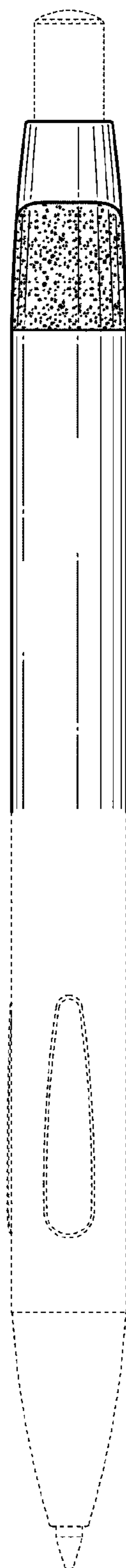

Fig. 3

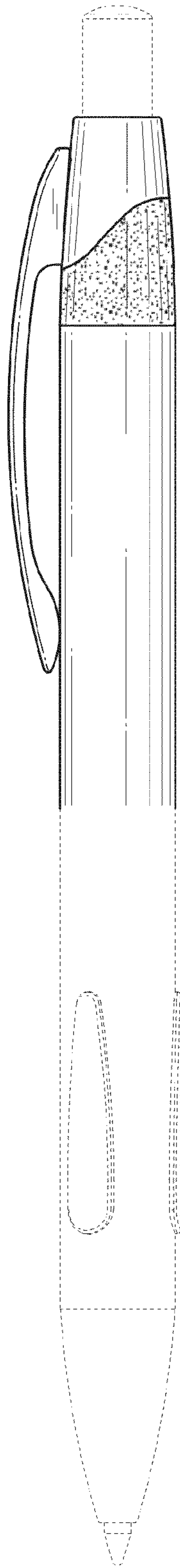

Fig. 4

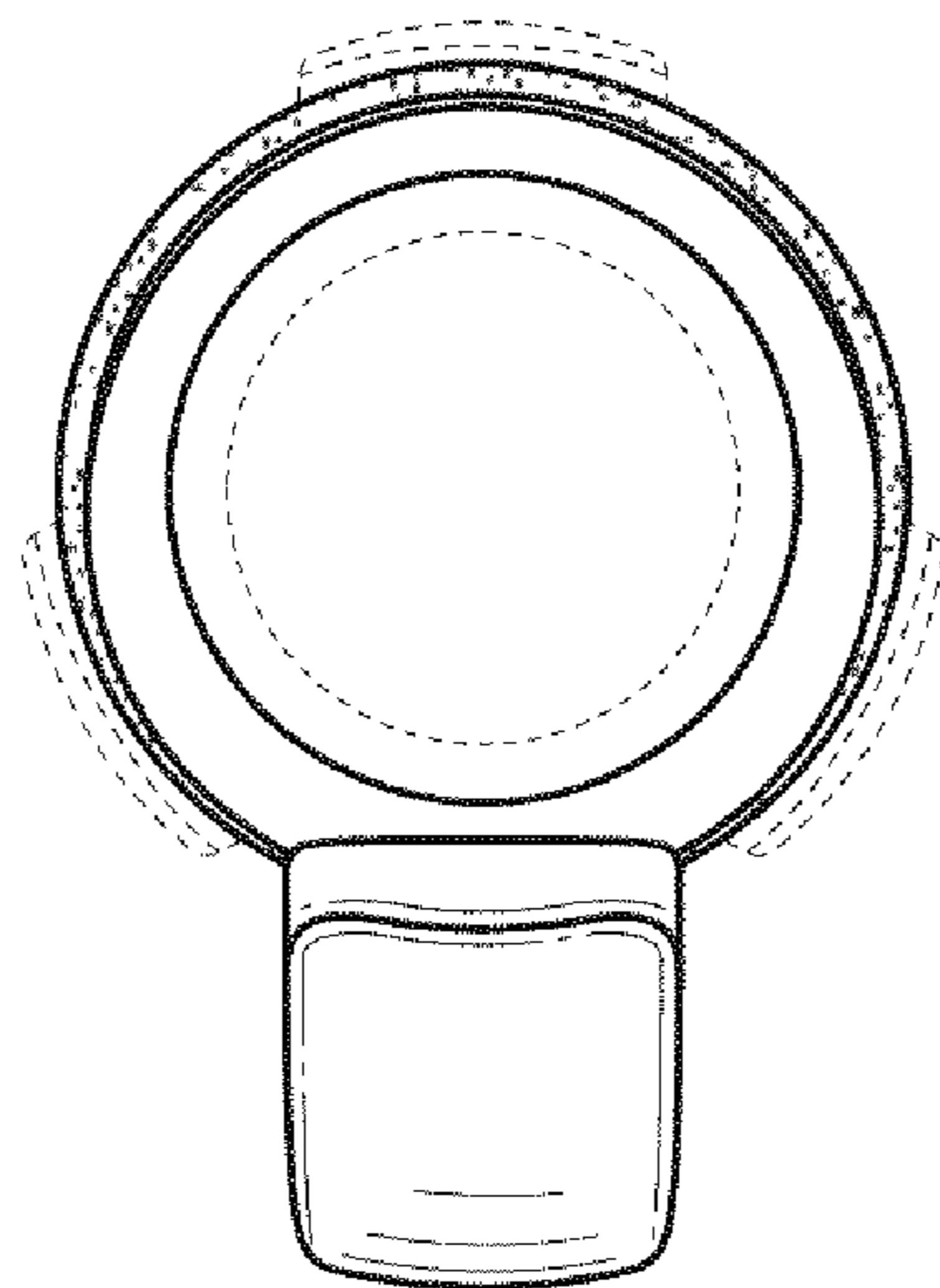

Fig. 5

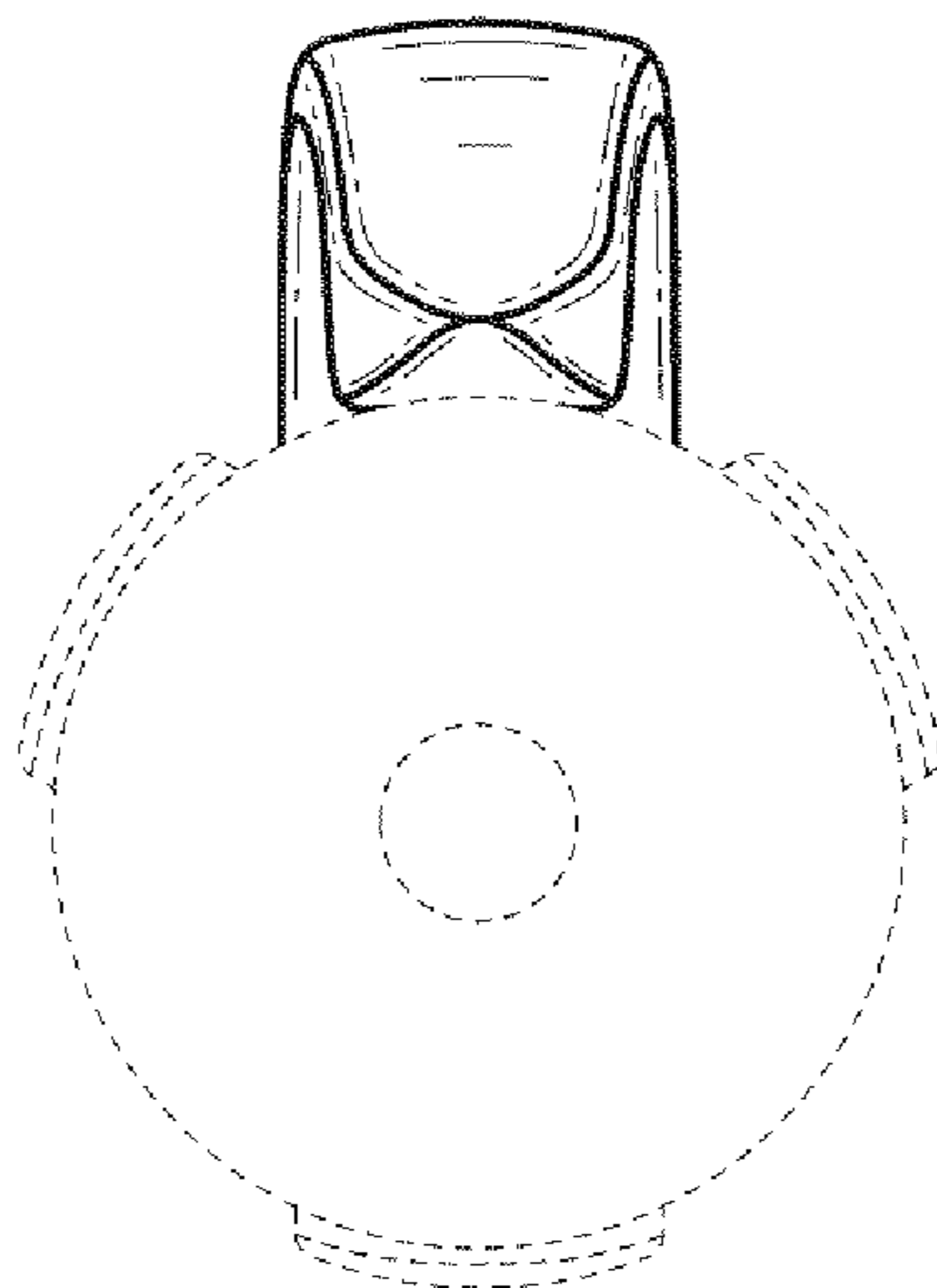

Fig. 6