



US00D652442S

(12) **United States Design Patent**  
**Yee et al.**

(10) **Patent No.:** **US D652,442 S**  
(45) **Date of Patent:** **\*\* Jan. 17, 2012**

(54) **EYEGLASS**  
(75) Inventors: **Peter Yee**, Irvine, CA (US); **Lek Thixton**, Irvine, CA (US)  
(73) Assignee: **Oakley, Inc.**, Foothill Ranch, CA (US)  
(\*\*) Term: **14 Years**  
(21) Appl. No.: **29/383,486**  
(22) Filed: **Jan. 18, 2011**  
(51) **LOC (9) Cl.** ..... **16-06**  
(52) **U.S. Cl.** ..... **D16/326**  
(58) **Field of Classification Search** ..... D16/101,  
D16/300-342, 900; D29/109-110; D24/110.2;  
351/41, 44, 51-52, 62, 158, 92, 103-123,  
351/140, 153, 45-46; 2/426-432, 447-449,  
2/441, 434-437, 13, 15; D21/483, 659-661  
See application file for complete search history.

D561,811 S 2/2008 Fox et al.  
D561,813 S 2/2008 Baden et al.  
D564,570 S 3/2008 Mage  
D564,572 S 3/2008 Yee et al.  
D572,747 S 7/2008 Baden et al.  
D572,749 S 7/2008 Yee  
D575,323 S 8/2008 Jannard et al.  
D585,928 S 2/2009 Markovitz  
D586,379 S 2/2009 Thixton et al.  
D595,333 S 6/2009 Markovitz et al.  
D599,838 S \* 9/2009 Rohrbach ..... D16/326  
D606,113 S 12/2009 Daems et al.  
D616,015 S 5/2010 Markovitz et al.  
D621,438 S \* 8/2010 Markovitz et al. .... D16/326  
D623,217 S 9/2010 Markovitz et al.  
D629,444 S \* 12/2010 Akarra et al. .... D16/326  
D629,830 S 12/2010 Markovitz et al.  
D630,674 S \* 1/2011 Markovitz ..... D16/326  
D645,076 S 9/2011 Markovitz et al.

\* cited by examiner

*Primary Examiner* — Raphael Barkai  
(74) *Attorney, Agent, or Firm* — Knobbe Martens Olson & Bear, LLP

(56) **References Cited**

**U.S. PATENT DOCUMENTS**

D210,418 S 3/1968 Bloch et al.  
5,080,476 A 1/1992 Monin  
5,231,429 A 7/1993 Kanda  
5,359,370 A 10/1994 Mugnier  
5,555,037 A 9/1996 Canavan  
D399,238 S 10/1998 Simioni  
D407,099 S 3/1999 Wang  
6,231,181 B1 5/2001 Swab  
6,336,250 B1 1/2002 Takeda et al.  
D534,573 S 1/2007 Mage  
D539,831 S 4/2007 Hsu  
D539,833 S 4/2007 Chuang  
D540,370 S 4/2007 Sheldon  
D545,348 S 6/2007 Chen  
D549,268 S 8/2007 Daems et al.  
D549,764 S 8/2007 Teng  
D558,816 S 1/2008 Yee

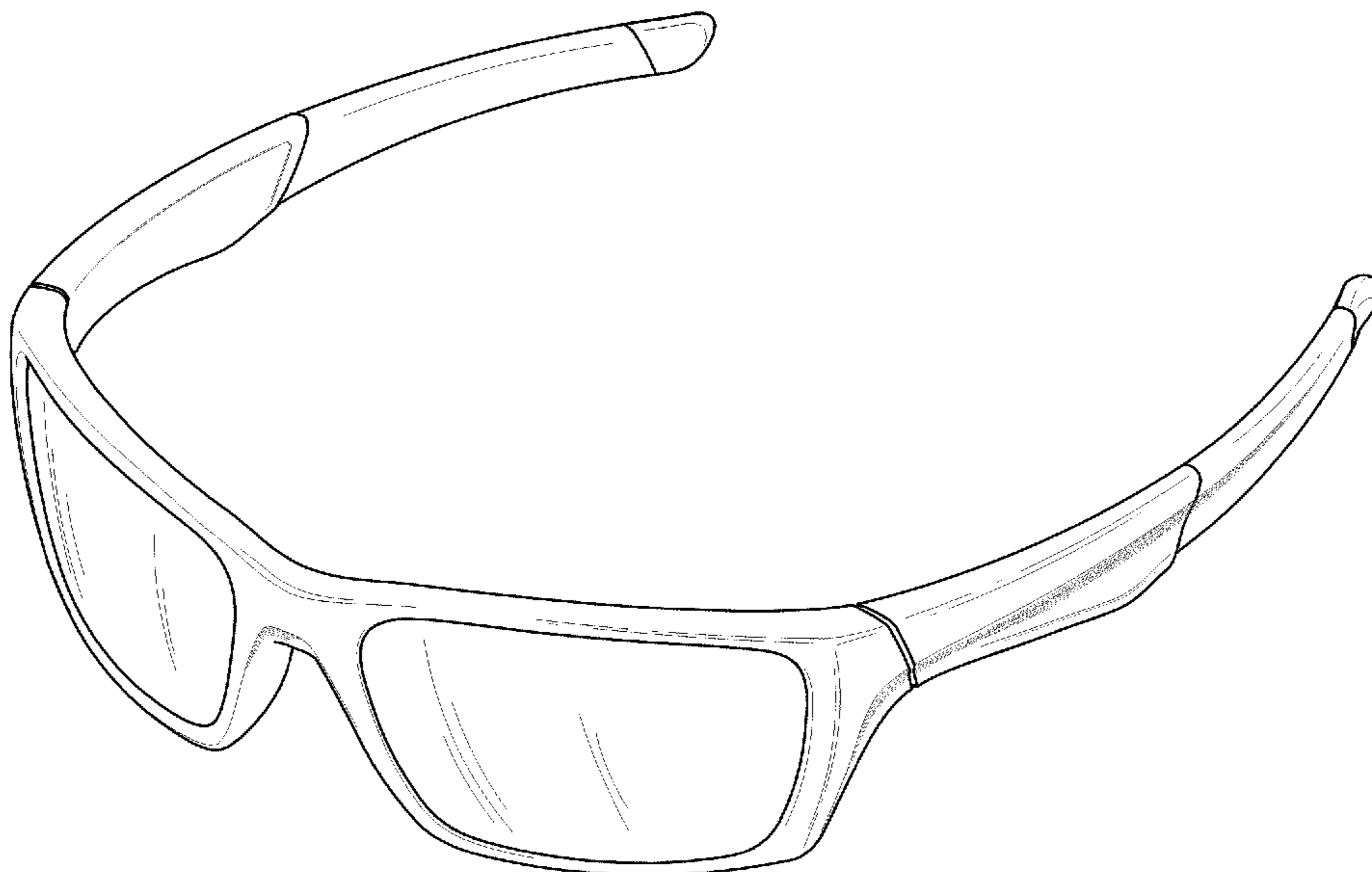
(57) **CLAIM**

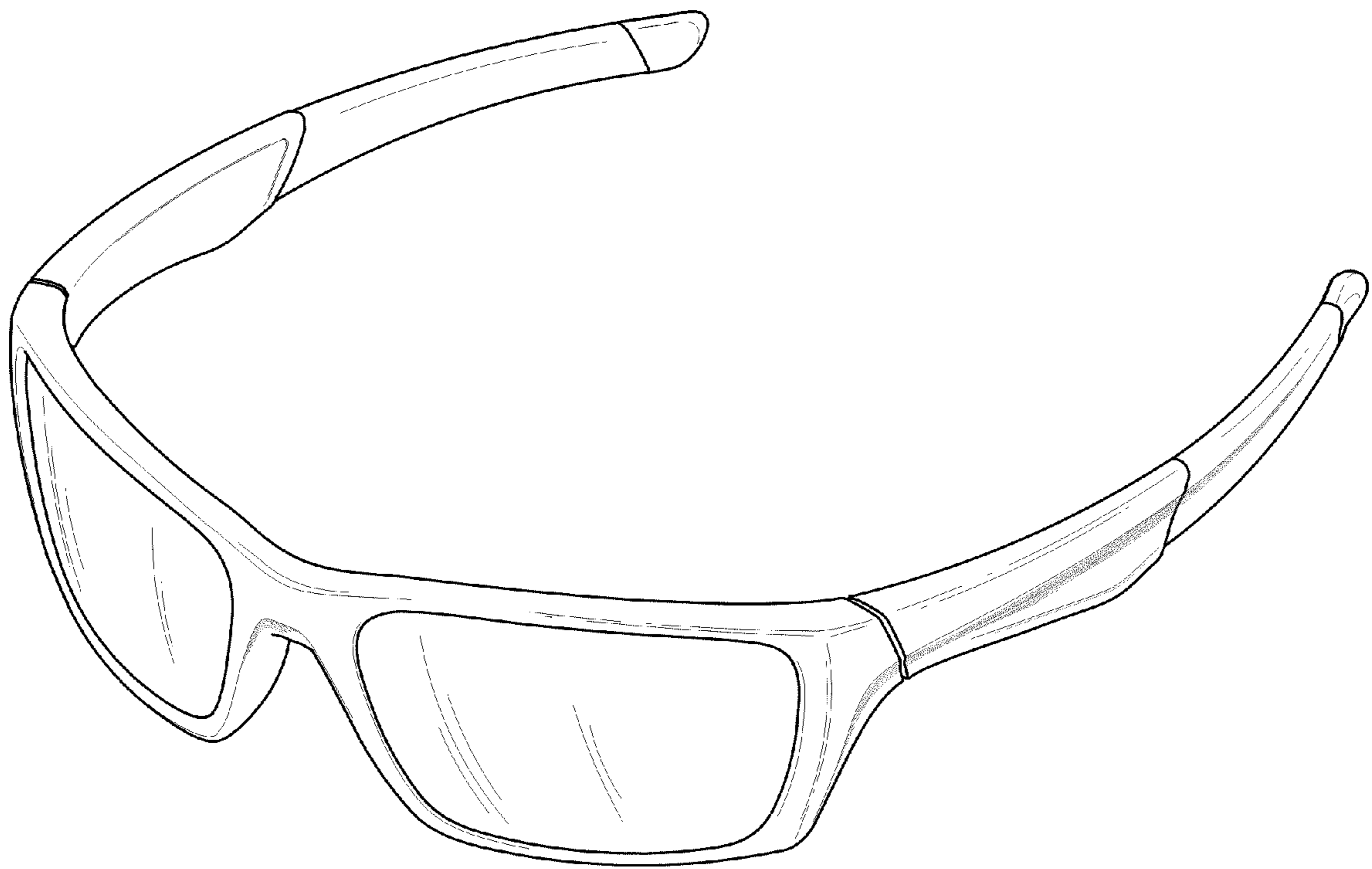
The ornamental design for an eyeglass, as shown and described.

**DESCRIPTION**

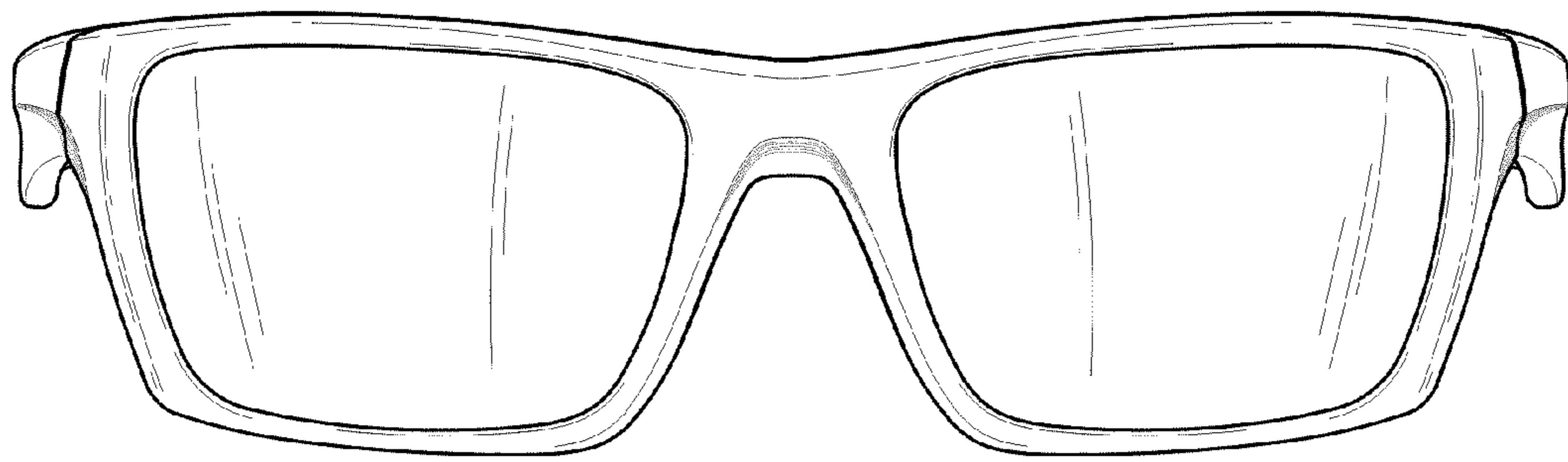
FIG. 1 is a front perspective view of an eyeglass of the present invention;  
FIG. 2 is a front elevational view of the eyeglass of FIG. 1;  
FIG. 3 is a rear elevational view of the eyeglass of FIG. 1;  
FIG. 4 is a left side elevational view of the eyeglass of FIG. 1, the right side elevational view being a minor image thereof;  
FIG. 5 is a top plan view of the eyeglass of FIG. 1; and,  
FIG. 6 is a bottom plan view of the eyeglass of FIG. 1.

**1 Claim, 4 Drawing Sheets**

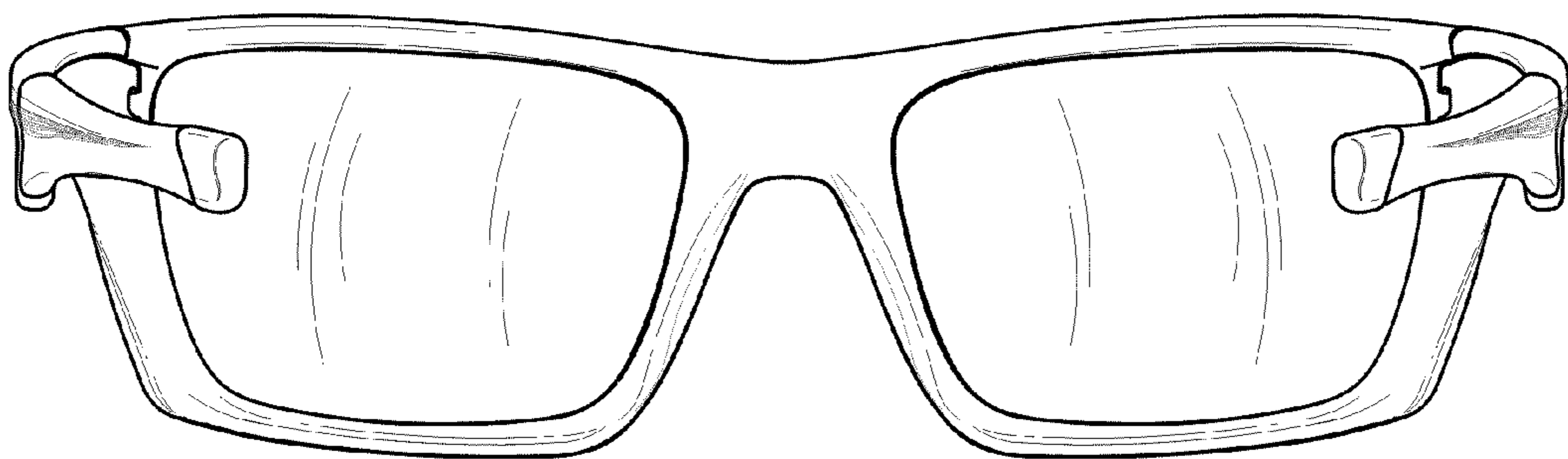




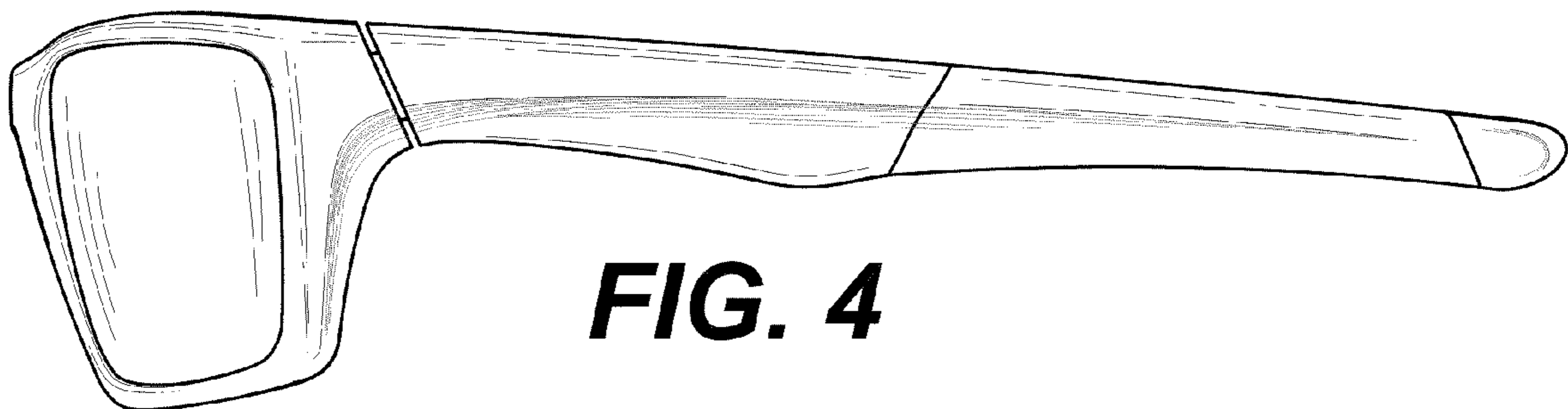
**FIG. 1**



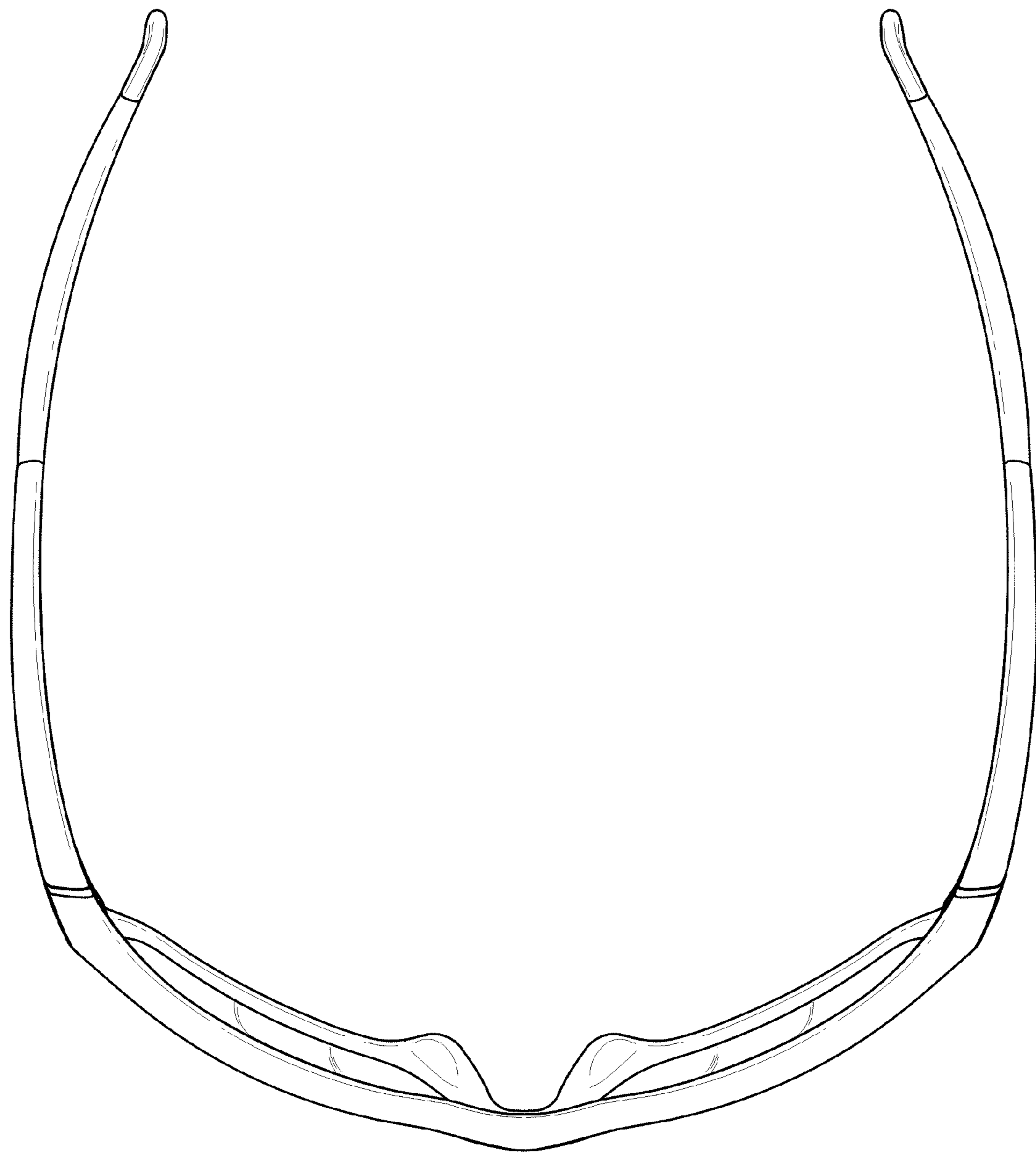
**FIG. 2**



**FIG. 3**

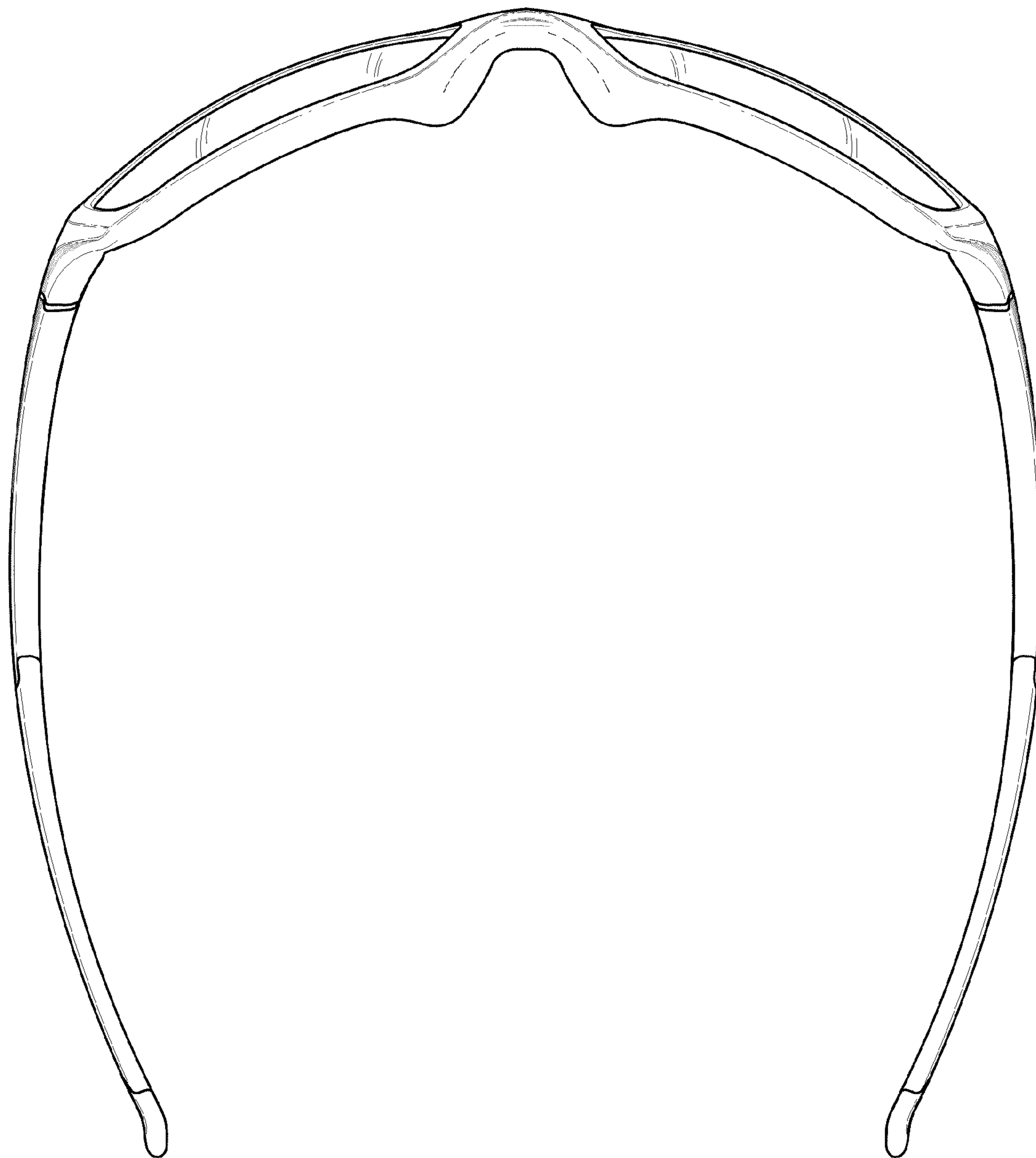


**FIG. 4**



**FIG. 5**

**FIG. 6**





UNITED STATES PATENT AND TRADEMARK OFFICE  
**CERTIFICATE OF CORRECTION**

PATENT NO. : D652,442 S  
APPLICATION NO. : 29/383486  
DATED : January 17, 2012  
INVENTOR(S) : Peter Yee et al.

Page 1 of 1

It is certified that error appears in the above-identified patent and that said Letters Patent is hereby corrected as shown below:

At Page 1, Column 2 (Description), Line 6, please change "minor" to --mirror--.

Signed and Sealed this  
Nineteenth Day of June, 2012

A handwritten signature in black ink that reads "David J. Kappos". The signature is written in a cursive style with a large initial "D" and "K".

David J. Kappos  
*Director of the United States Patent and Trademark Office*