



US00D652431S

(12) **United States Design Patent**
Näslund

(10) **Patent No.:** **US D652,431 S**
(45) **Date of Patent:** **** Jan. 17, 2012**

(54) **ROBOTIC LAWNMOWER**
(75) Inventor: **Jens Näslund**, Bromma (SE)
(73) Assignee: **Husqvarna AB**, Huskvarna (SE)
(**) Term: **14 Years**
(21) Appl. No.: **29/401,010**
(22) Filed: **Sep. 6, 2011**

D504,901 S * 5/2005 Wickstrom et al. D15/14
D559,867 S * 1/2008 Abramson D15/14
D566,136 S * 4/2008 Green D15/14
D573,610 S * 7/2008 Abramson D15/14
D643,048 S * 8/2011 Pflum D15/11

* cited by examiner

Primary Examiner — Mark Goodwin
(74) *Attorney, Agent, or Firm* — Novak Druce & Quigg LLP

(30) **Foreign Application Priority Data**

Mar. 18, 2011 (EM) 001837824

(51) **LOC (9) Cl.** **15-03**
(52) **U.S. Cl.** **D15/14**
(58) **Field of Classification Search** D15/14,
D15/17, 18; 56/11.9, 17.5, 13.4, 12.8, 16.7,
56/202, 255, 294, 295, 320.1, 320.2; 180/900,
180/89.1, 89.12
See application file for complete search history.

(57) **CLAIM**

I claim the ornamental design for a robotic lawnmower, as shown and described.

DESCRIPTION

FIG. 1 is a top perspective view of a robotic lawnmower showing my new design;
FIG. 2 is a top plan view thereof;
FIG. 3 is a bottom plan view thereof;
FIG. 4 is a front elevational view thereof;
FIG. 5 is a left side elevational view thereof;
FIG. 6 is a right side elevational view thereof; and,
FIG. 7 is a rear elevational view thereof.
The broken lines are to illustrate unclaimed portions of the robotic lawnmower; the broken lines form no part of the claimed design.

(56) **References Cited**

U.S. PATENT DOCUMENTS

D346,809 S * 5/1994 Burgos et al. D15/14
D420,365 S * 2/2000 Gunnar D15/14
D451,931 S * 12/2001 Abramson et al. D15/14

1 Claim, 7 Drawing Sheets

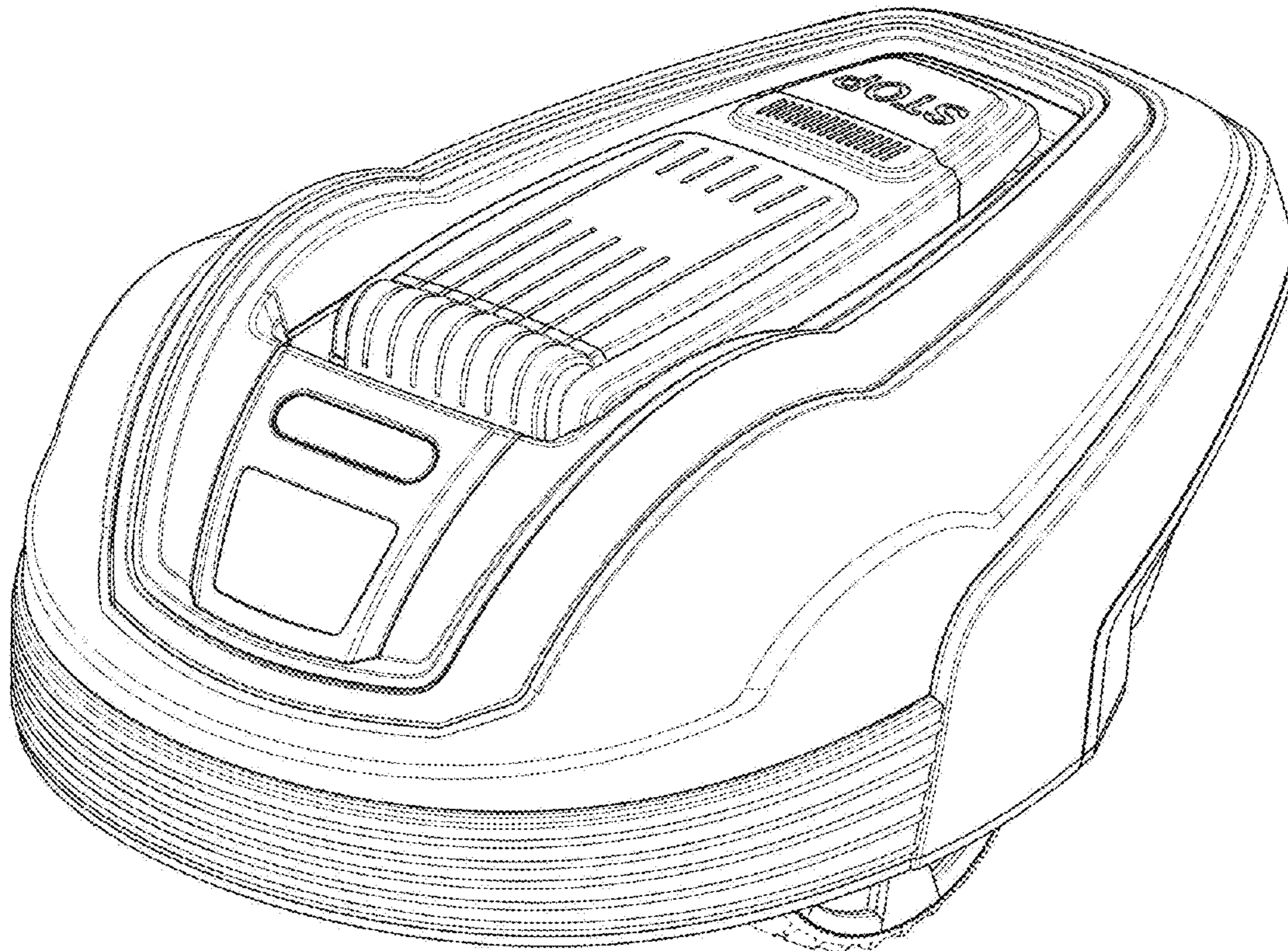

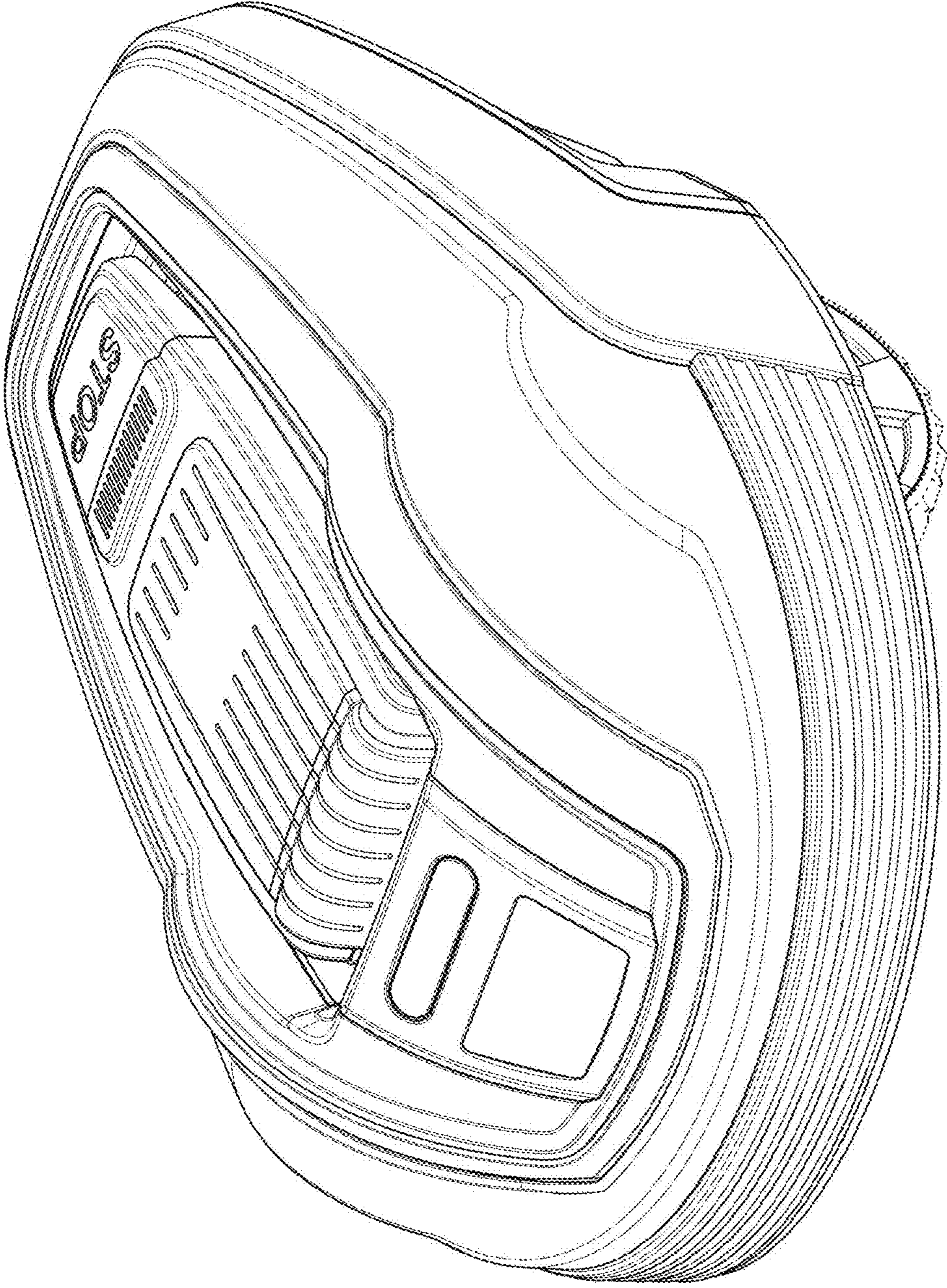

FIG. 1

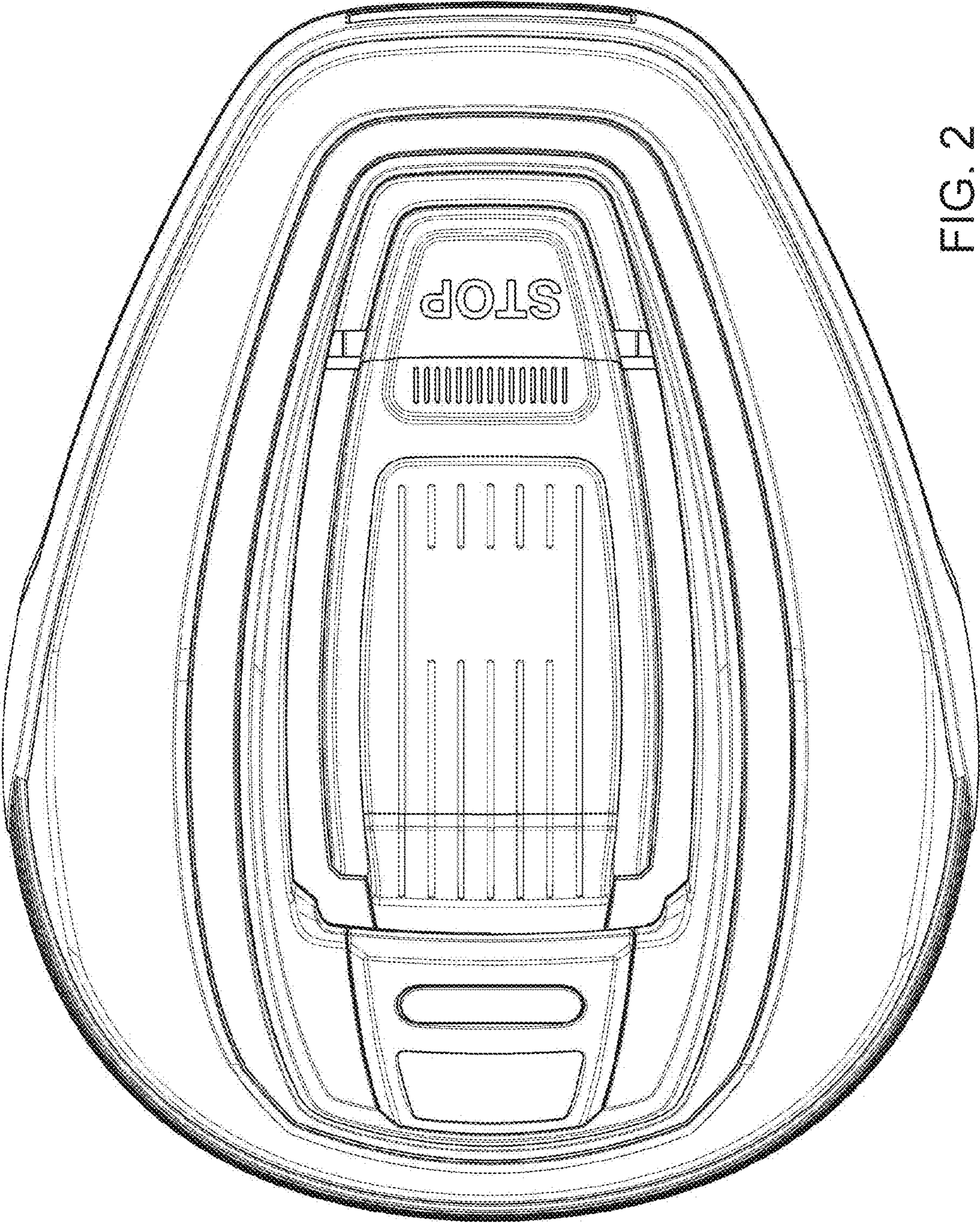

FIG. 2

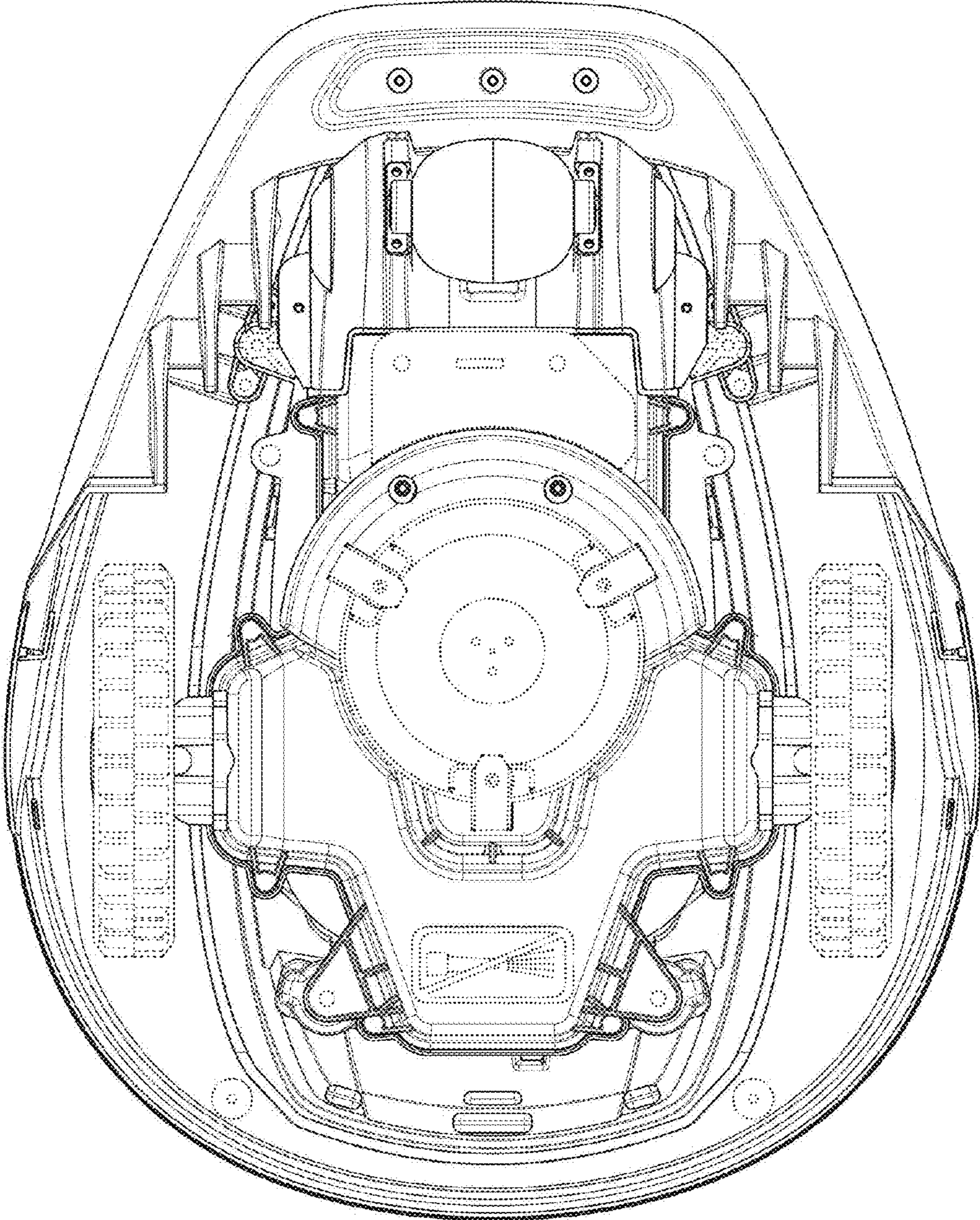

FIG. 3

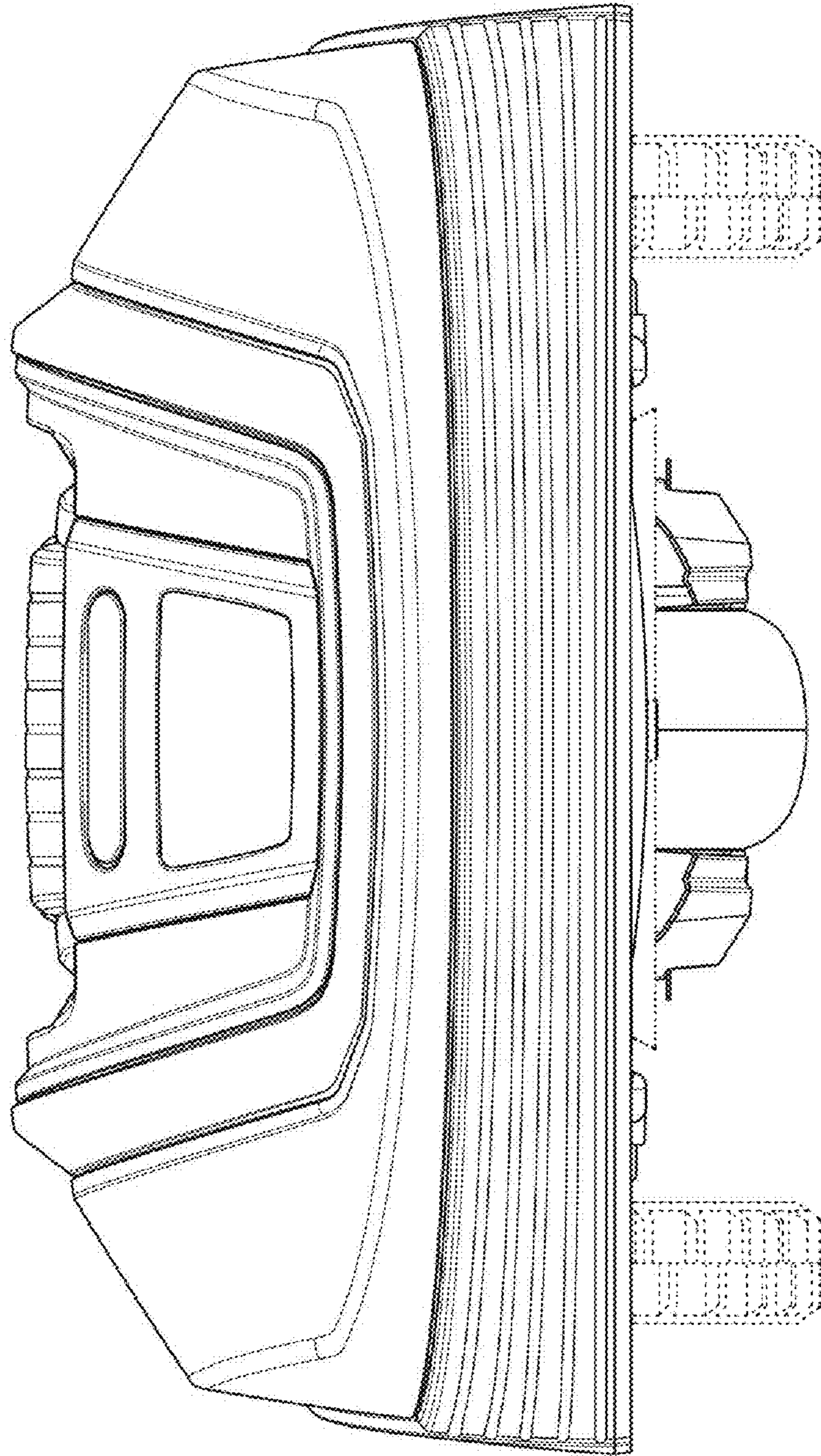

FIG. 4

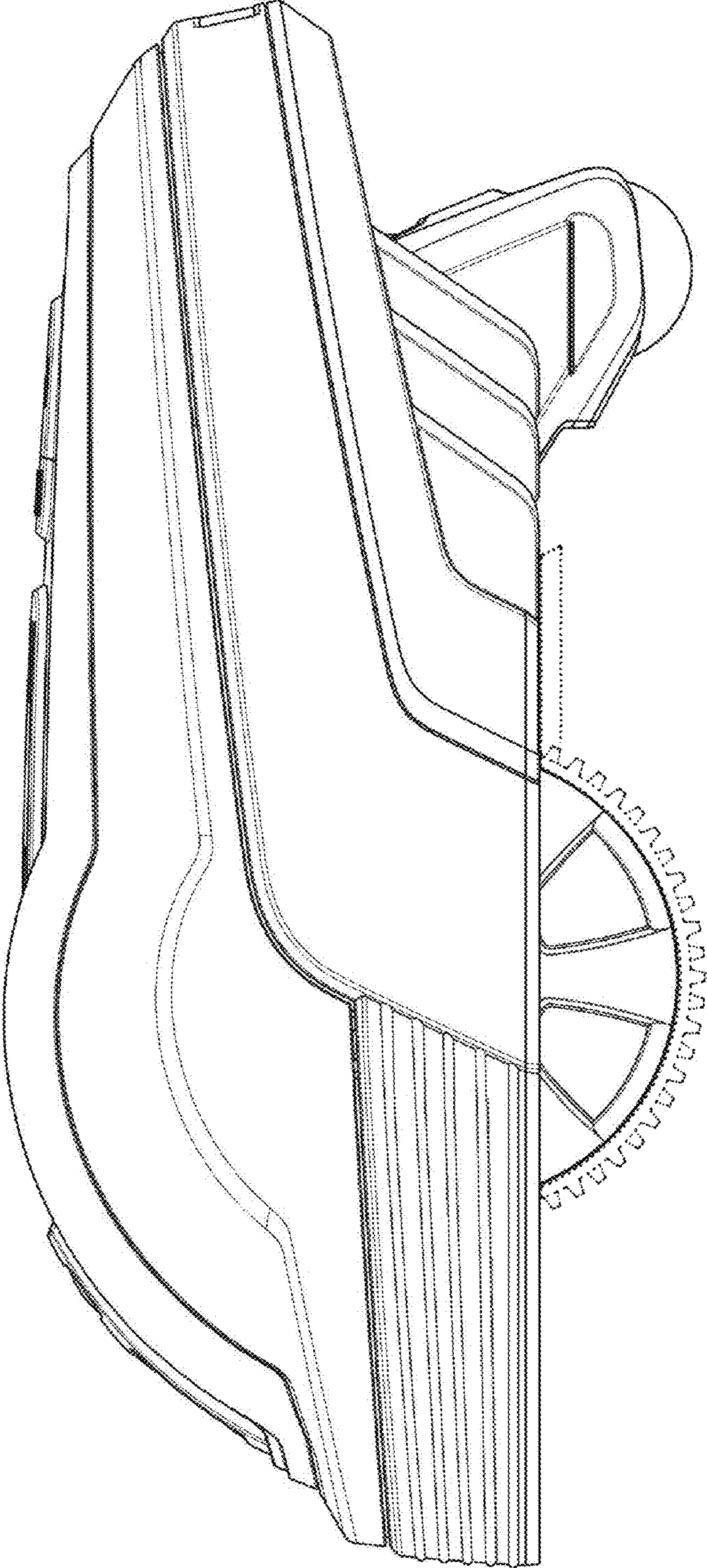

FIG. 5

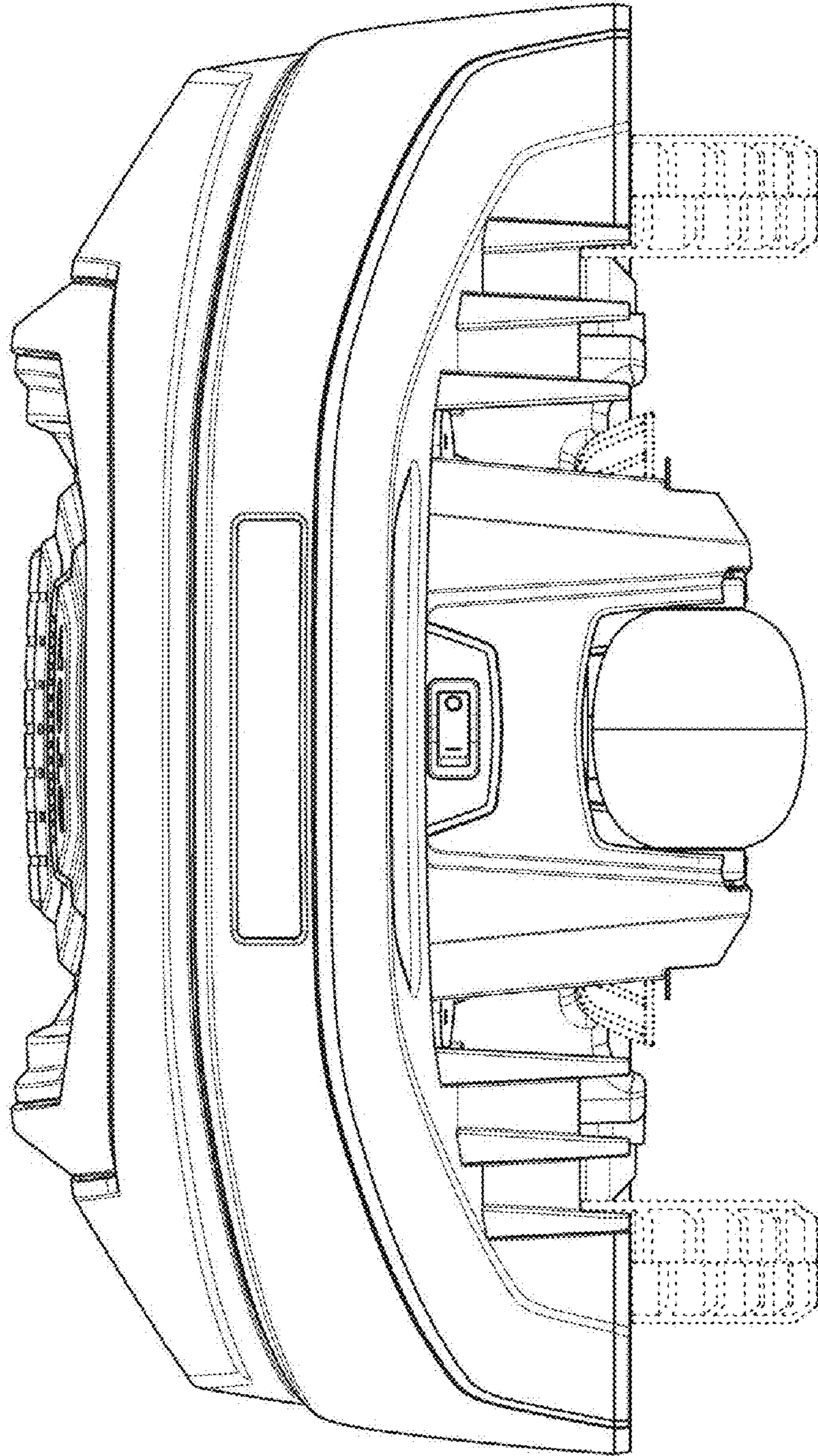

FIG. 6

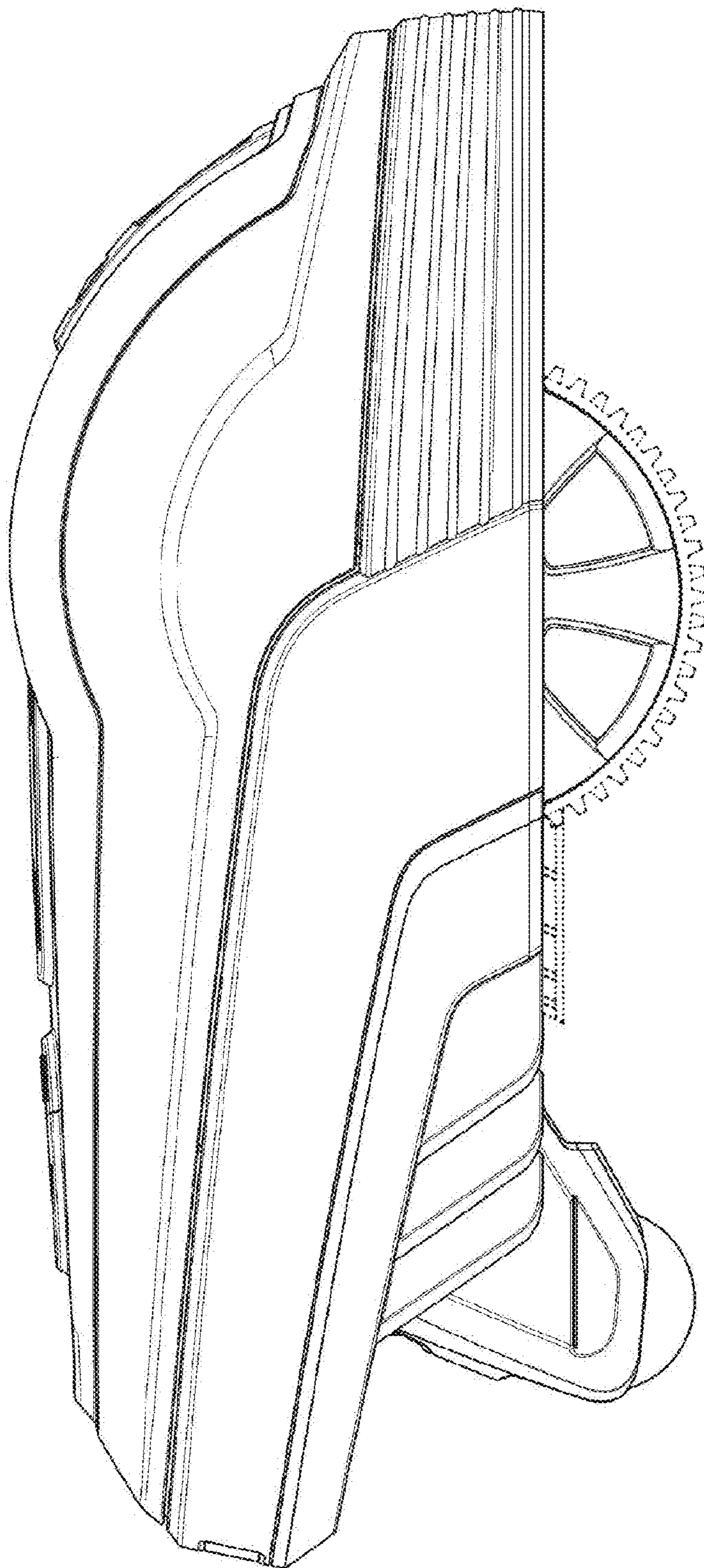

FIG. 7