



US00D652419S

(12) **United States Design Patent**  
**Chiu**

(10) **Patent No.:** **US D652,419 S**  
(45) **Date of Patent:** **\*\* Jan. 17, 2012**

(54) **DISPLAY**

(75) Inventor: **Yi-Chung Chiu**, Taoyuan (TW)

(73) Assignee: **Hannspree, Inc.**, Taipei County (TW)

(\*\*) Term: **14 Years**

(21) Appl. No.: **29/362,980**

(22) Filed: **Jun. 2, 2010**

(51) **LOC (9) Cl.** ..... **14-02**

(52) **U.S. Cl.** ..... **D14/371; D6/308**

(58) **Field of Classification Search** ..... D14/371-375,  
D14/125-129, 336, 337; 341/12; 345/104,  
345/156, 168, 173; 348/180, 184, 325, 739;  
349/1, 2, 11, 62; 361/679.06, 679.21; D6/300,  
D6/308

See application file for complete search history.

(56) **References Cited**

**U.S. PATENT DOCUMENTS**

D398,659 S \* 9/1998 Yokoi ..... D21/333  
6,227,966 B1 \* 5/2001 Yokoi ..... 463/1

D468,738 S \* 1/2003 Lin ..... D14/371  
D469,089 S \* 1/2003 Lin ..... D14/371  
D469,093 S \* 1/2003 Lin ..... D14/375  
D469,765 S \* 2/2003 Lin ..... D14/375  
D495,709 S \* 9/2004 Walker et al. .... D14/375  
D526,978 S \* 8/2006 Hoehn et al. .... D14/126  
D533,854 S \* 12/2006 Rashid ..... D14/126

\* cited by examiner

*Primary Examiner* — Freda S Nunn

(74) *Attorney, Agent, or Firm* — Schmeiser Olsen & Watts  
LLP

(57) **CLAIM**

The ornamental design for a display, as shown and described.

**DESCRIPTION**

FIG. 1 is a front perspective view of display showing my new design;

FIG. 2 is a front elevational view thereof;

FIG. 3 is a rear elevational view thereof;

FIG. 4 is a left side elevational view thereof;

FIG. 5 is a top plan view thereof; and,

FIG. 6 is a bottom plan view thereof.

**1 Claim, 3 Drawing Sheets**

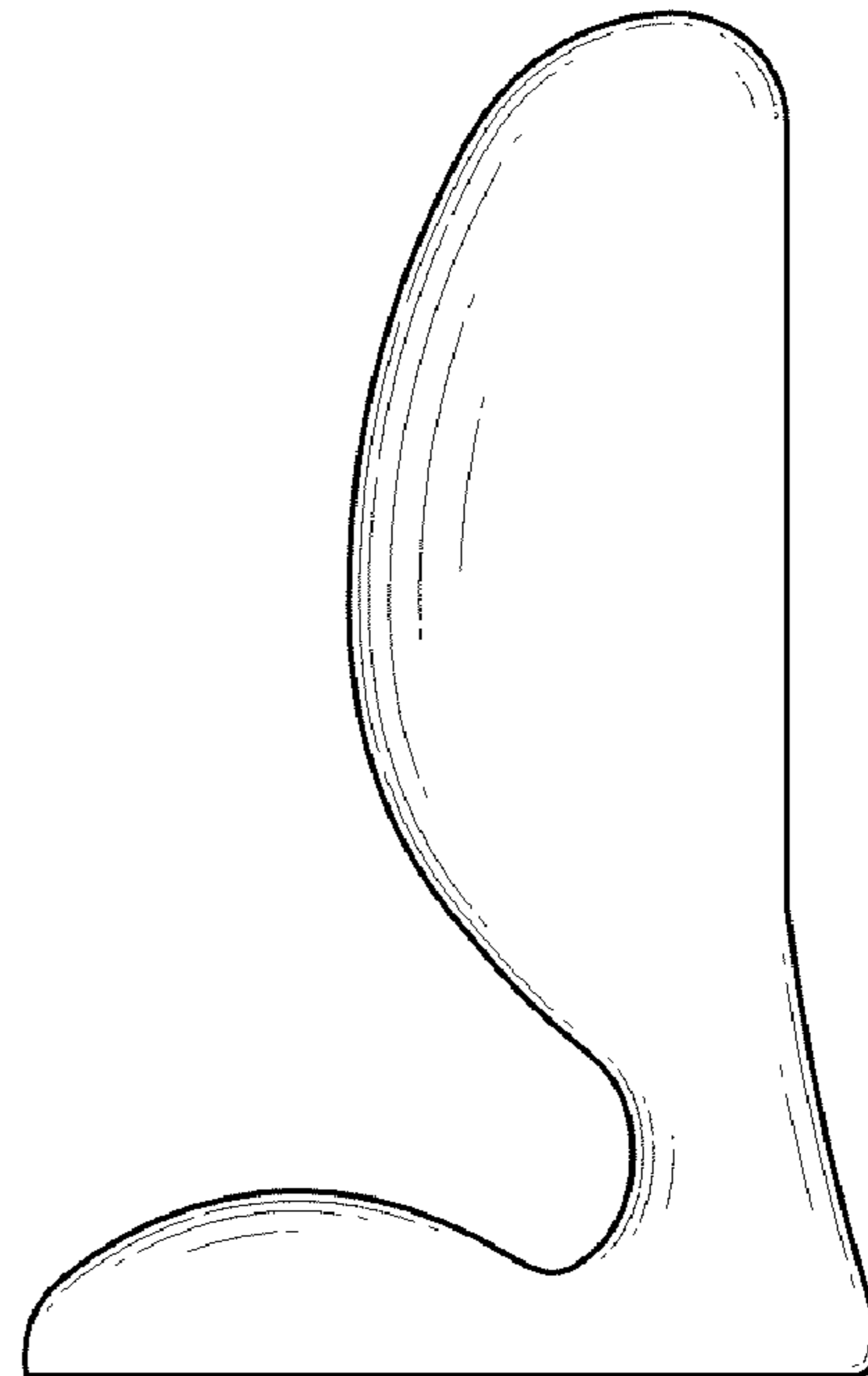
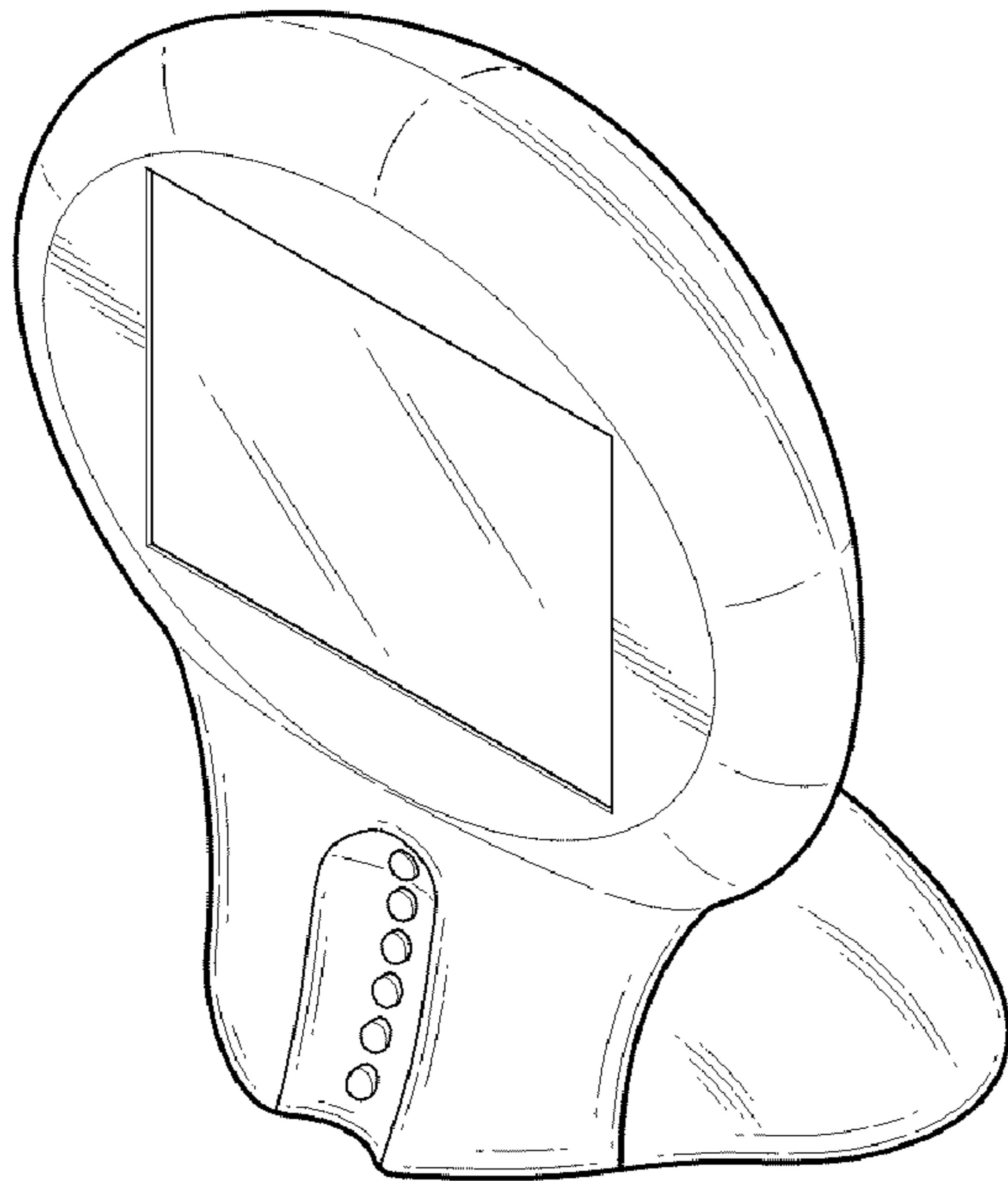

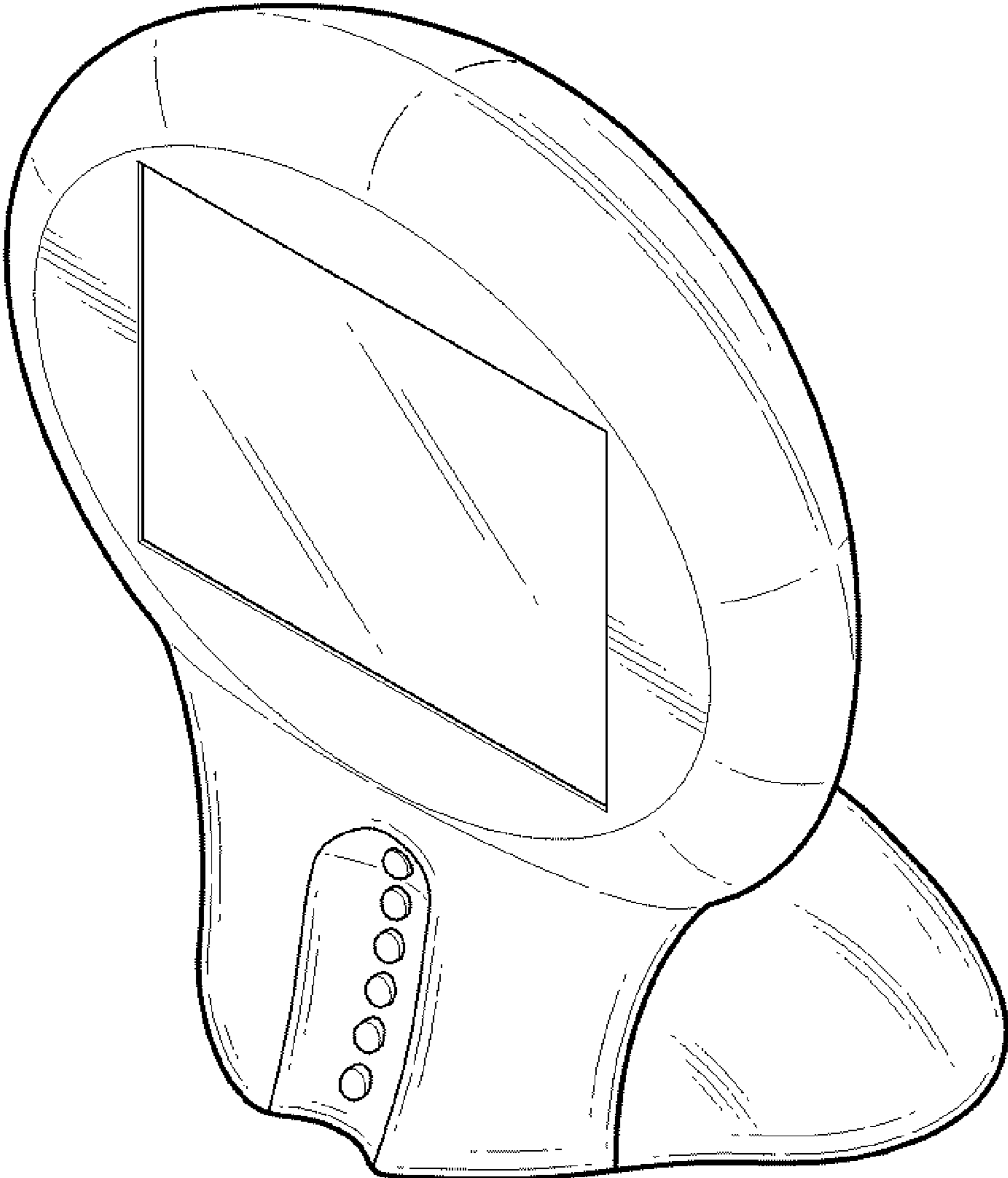

FIG. 1

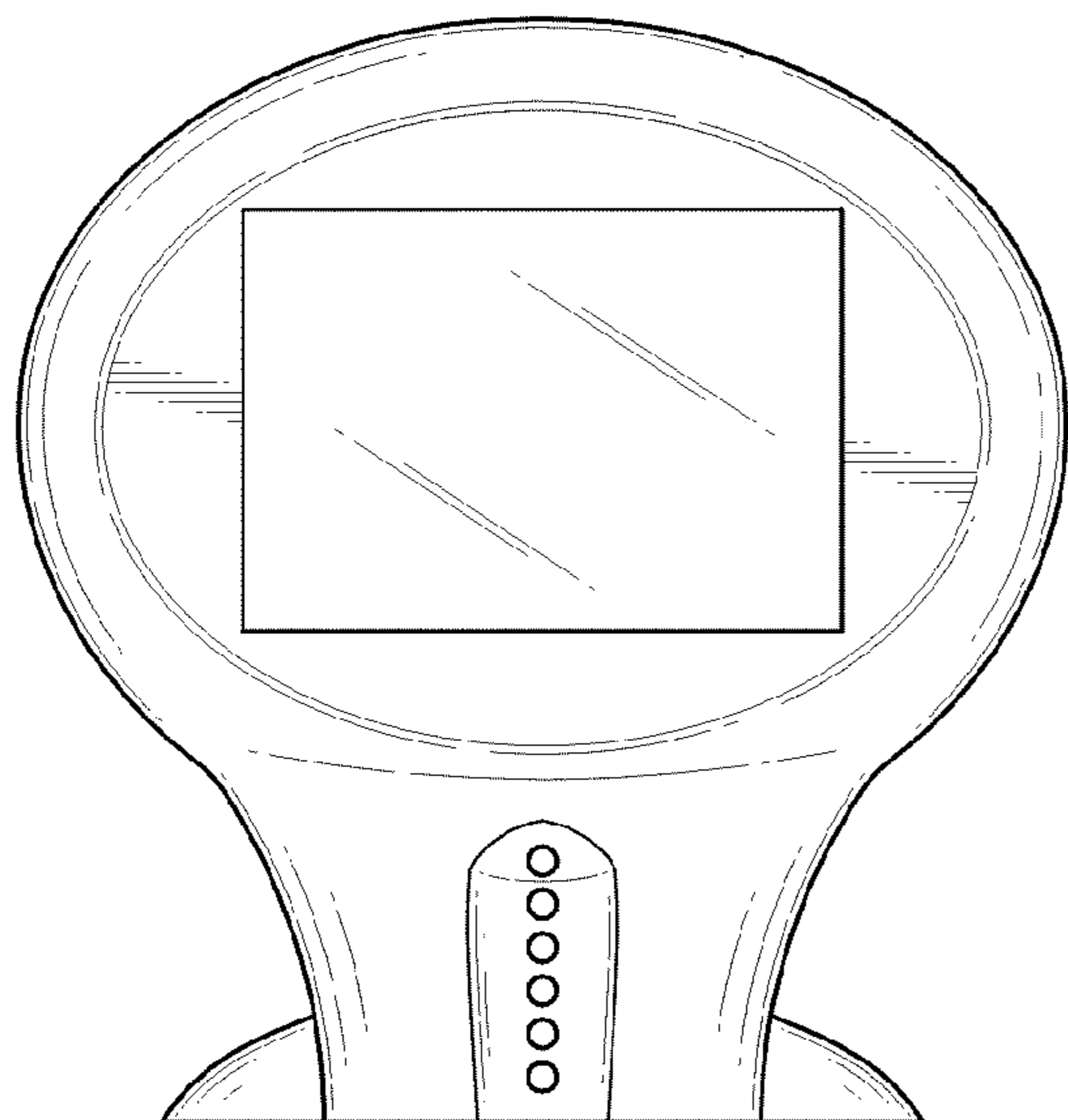

FIG. 2

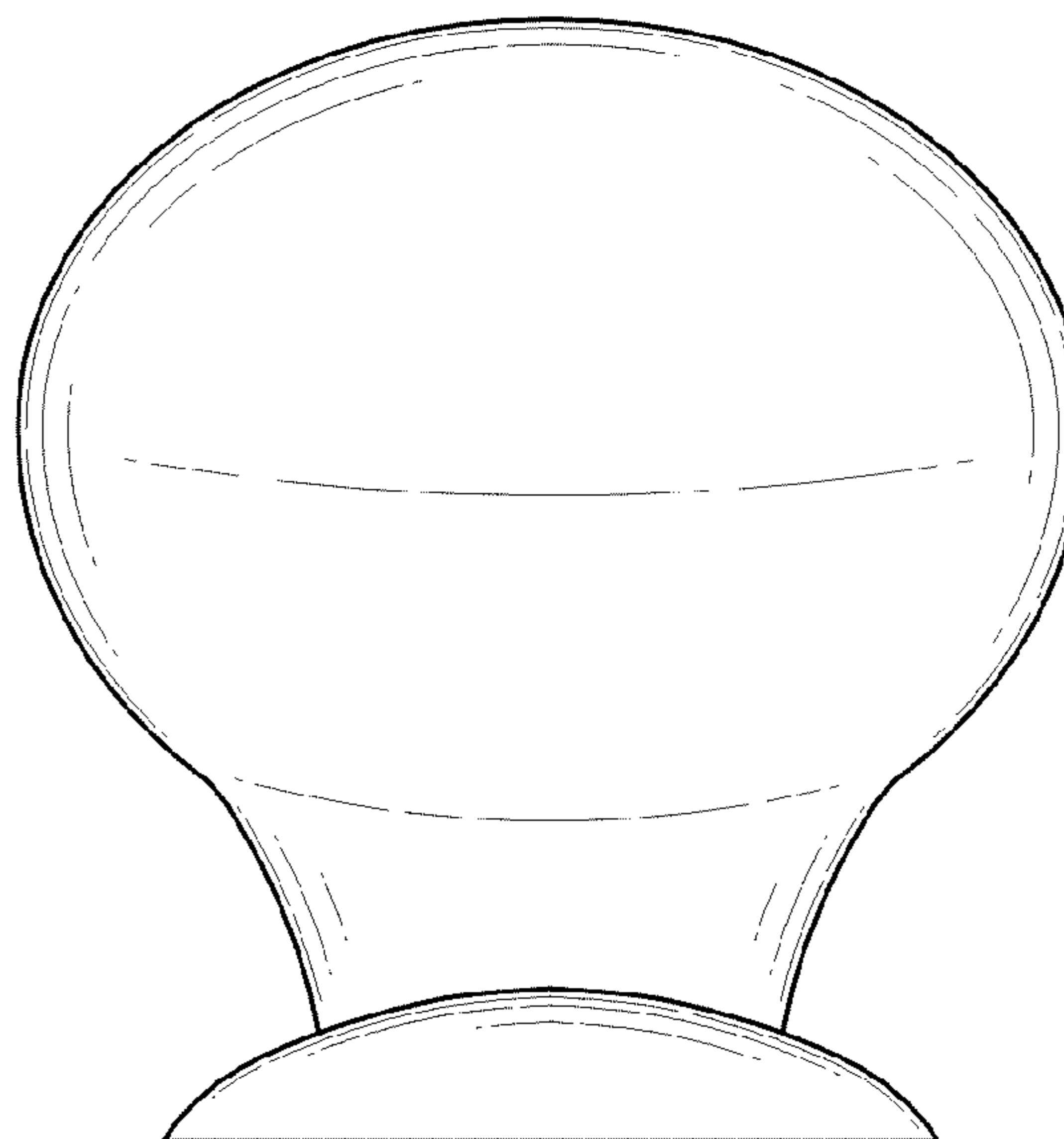

FIG. 3

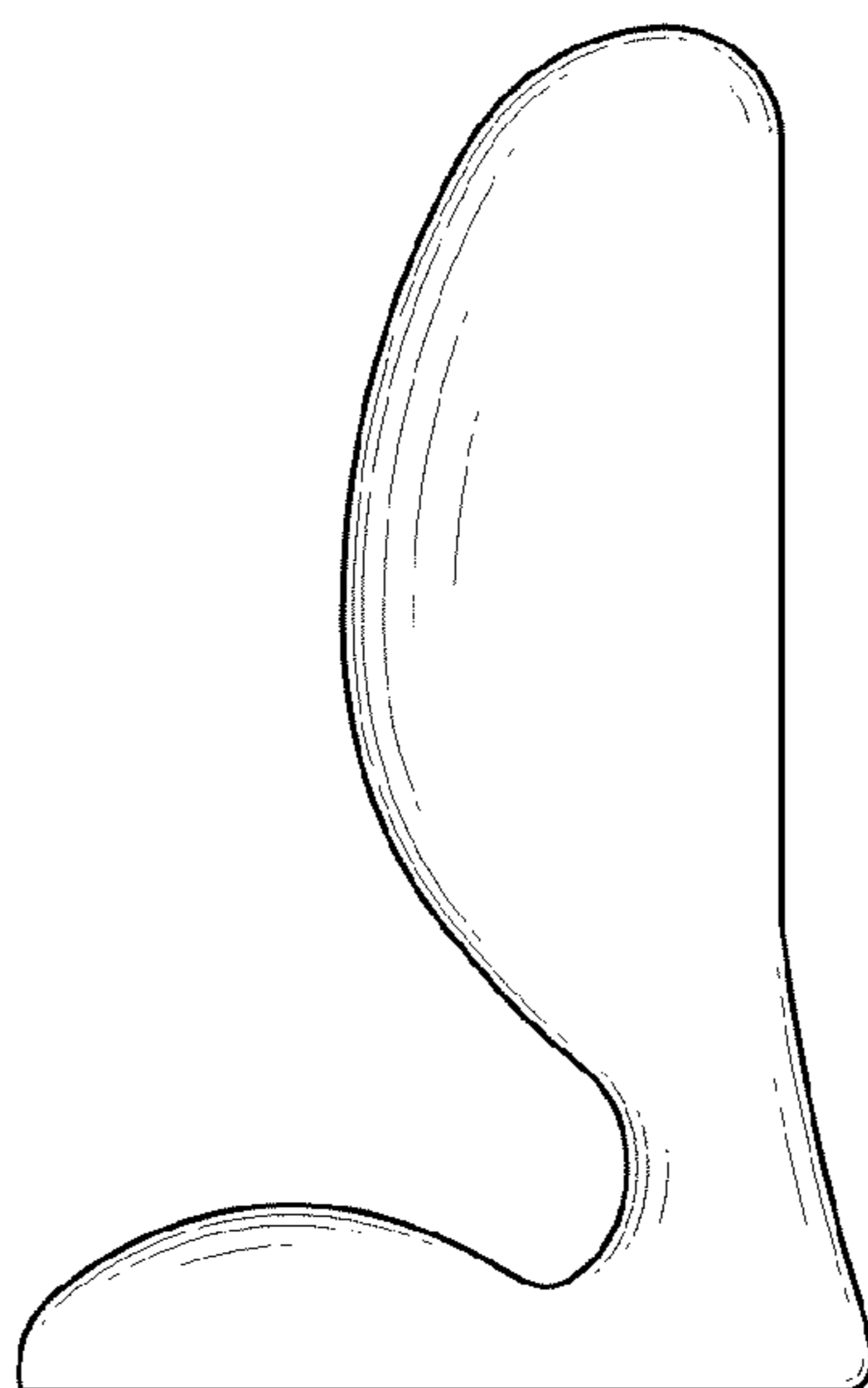

FIG. 4

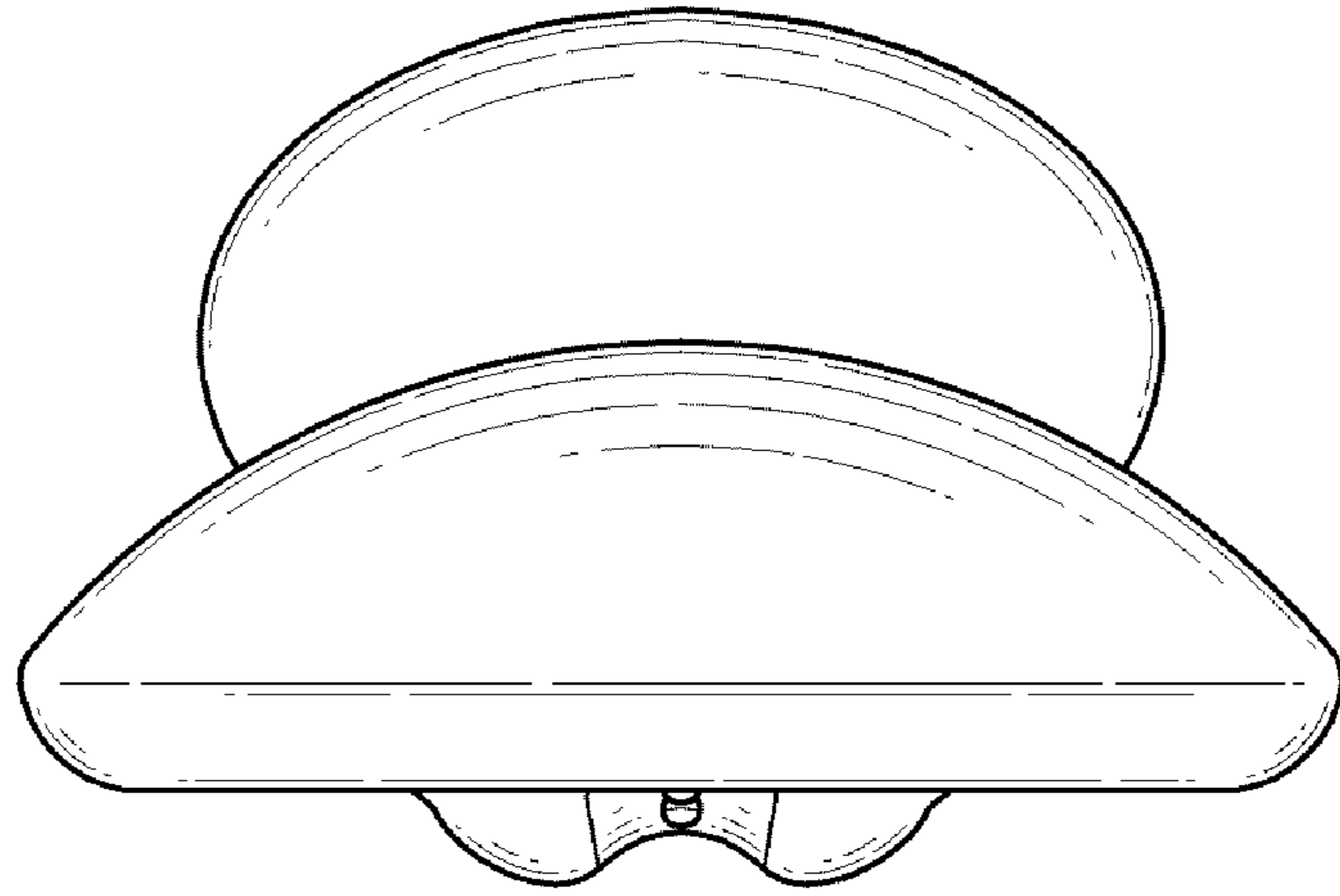

FIG. 5

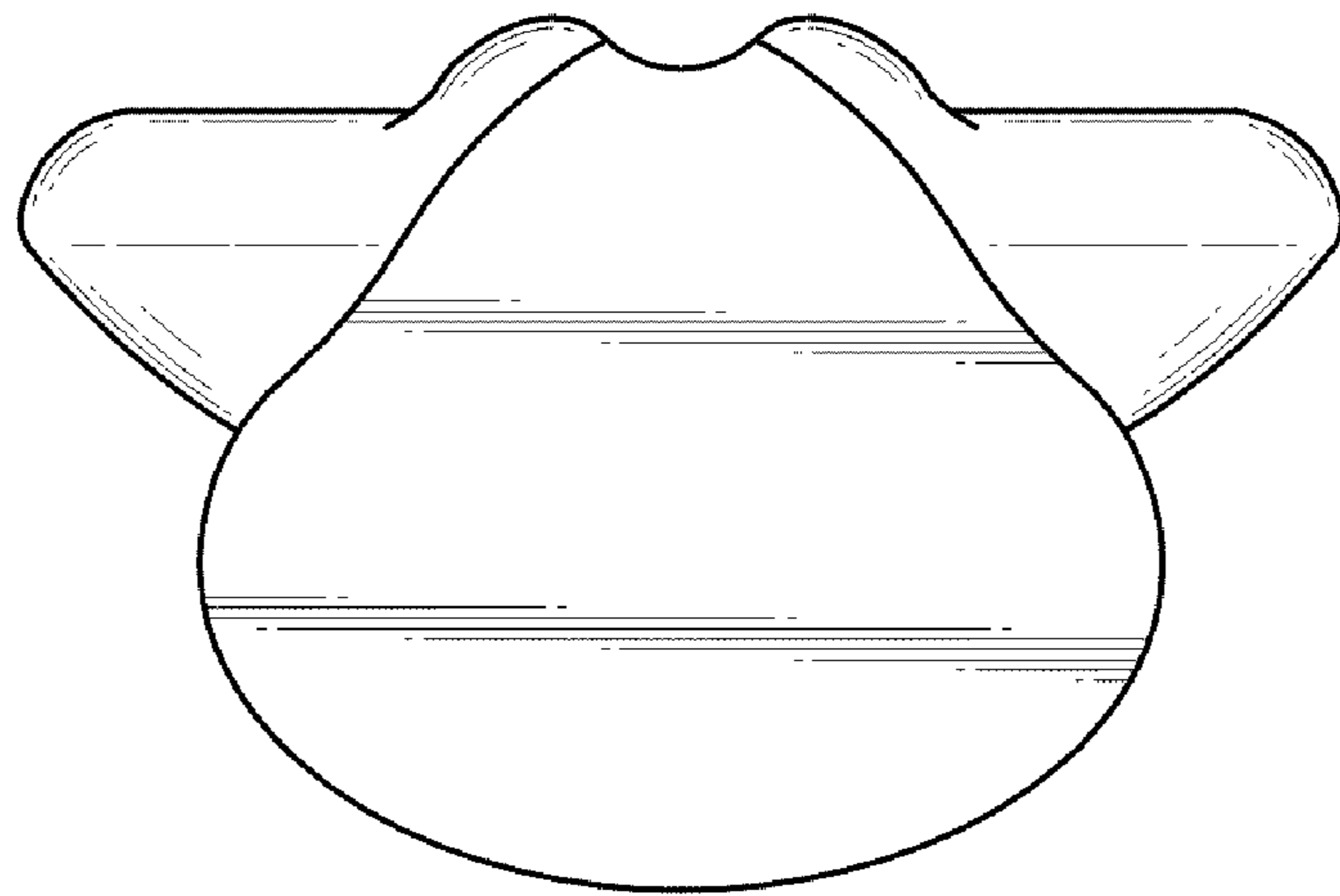

FIG. 6