



US00D652416S

(12) **United States Design Patent**
Park et al.

(10) **Patent No.:** **US D652,416 S**
(45) **Date of Patent:** **** Jan. 17, 2012**

(54) **NOTEBOOK COMPUTER**

(75) Inventors: **Ji-Sang Park**, Kyunggi-do (KR);
Yeo-Wan Yun, Kyunggi-do (KR)

(73) Assignee: **Samsung Electronics Co., Ltd.**, Suwon
(KR)

(**) Term: **14 Years**

(21) Appl. No.: **29/390,460**

(22) Filed: **Apr. 25, 2011**

(30) **Foreign Application Priority Data**

Jan. 13, 2011 (KR) 30-2011-0001468

(51) **LOC (9) Cl.** **14-02**

(52) **U.S. Cl.** **D14/315**

(58) **Field of Classification Search** D14/315-328;
D18/1, 2, 7, 11; 235/145 A, 145 R; 341/22,
341/23; 345/104, 156, 168, 169, 173, 87,
345/901-905; 361/679.08-679.18, 679.27;
400/486, 489

See application file for complete search history.

(56) **References Cited**

U.S. PATENT DOCUMENTS

D332,944 S	2/1993	Kim	
D334,738 S	4/1993	Kim	
D335,870 S	5/1993	Yun	
D336,465 S	6/1993	Kim	
D338,457 S	8/1993	Kim	
D348,442 S	7/1994	Yoon	
D416,238 S *	11/1999	Irie et al.	D14/318
6,067,224 A *	5/2000	Nobuchi	361/679.27
6,259,597 B1 *	7/2001	Anzai et al.	361/679.55
D463,797 S *	10/2002	Andre et al.	D14/327
6,519,139 B2 *	2/2003	Kambayashi	361/679.09
D492,678 S	7/2004	Kim et al.	
D523,010 S	6/2006	Paek et al.	
D523,431 S	6/2006	Yoon	
D523,851 S	6/2006	Jeong et al.	
D523,852 S	6/2006	Kim et al.	
D524,306 S	7/2006	Yun et al.	

D524,307 S	7/2006	Kim et al.	
D535,652 S	1/2007	Lee et al.	
D547,309 S	7/2007	Yoon	
D547,310 S	7/2007	Yoon	
D556,192 S	11/2007	Jeong et al.	
D564,511 S *	3/2008	Akhtar	D14/318
D567,236 S	4/2008	Yoon	
D578,523 S	10/2008	Yoon	
D578,524 S	10/2008	Yoon	
D578,525 S	10/2008	Yoon	
D580,432 S	11/2008	Yun et al.	
D586,343 S	2/2009	Lee et al.	

(Continued)

FOREIGN PATENT DOCUMENTS

KR 3005506890000 1/2010

(Continued)

OTHER PUBLICATIONS

U.S. Appl. No. 29/370,831, Applicant: Seung-Ho Jung, et al., filed
Sep. 10, 2010 entitled Notebook Computer.

(Continued)

Primary Examiner — Freda S Nunn

(74) *Attorney, Agent, or Firm* — Wood, Herron & Evans,
LLP

(57) **CLAIM**

The ornamental design for a notebook computer, as shown
and described.

DESCRIPTION

FIG. 1 is a top front perspective view of a notebook computer
showing our new design;
FIG. 2 is a front elevational view thereof;
FIG. 3 is a rear elevational view thereof;
FIG. 4 is a left side elevational view thereof;
FIG. 5 is a right side elevational view thereof;
FIG. 6 is a top plan view thereof; and,
FIG. 7 is a bottom plan view thereof.

1 Claim, 4 Drawing Sheets

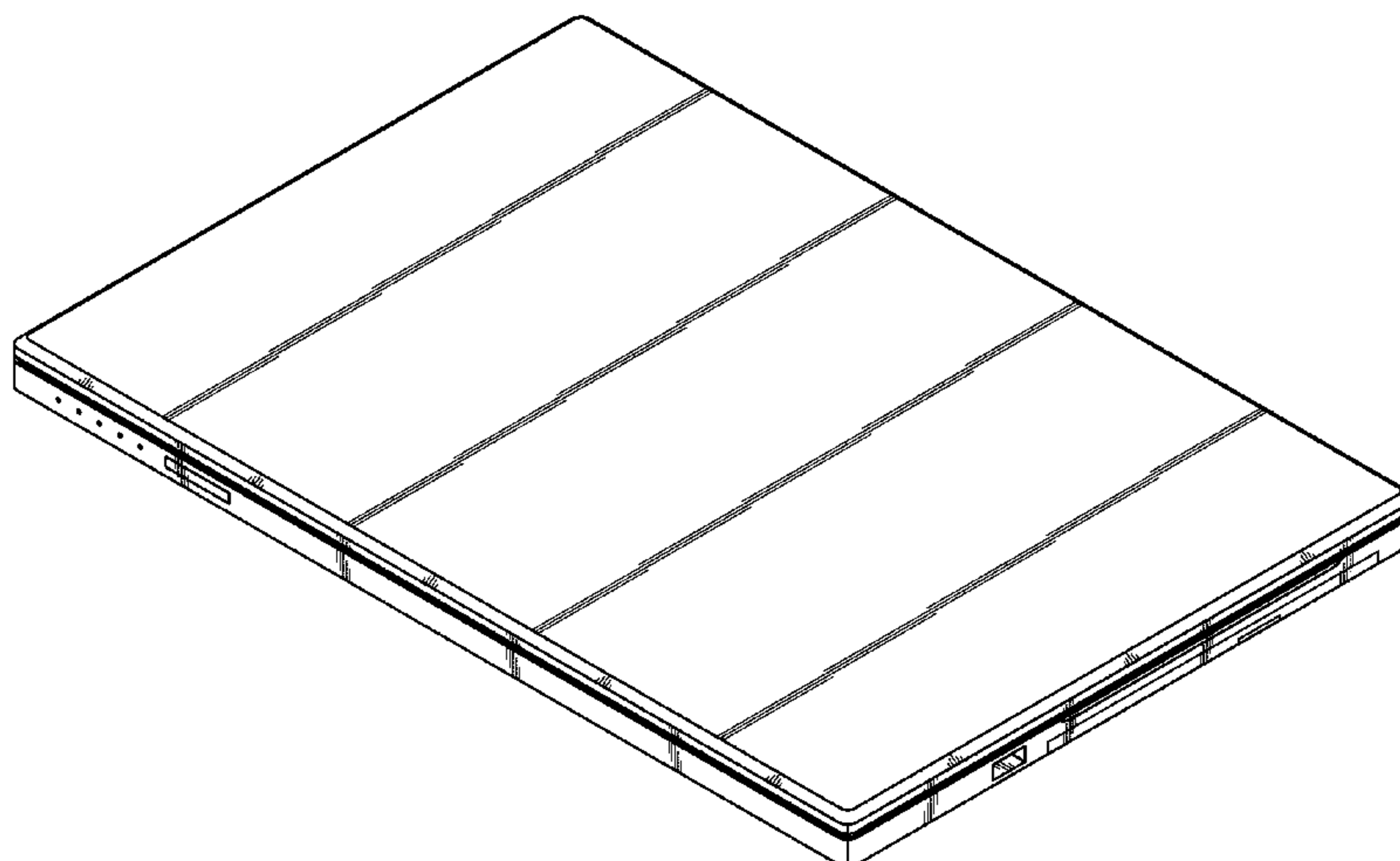

U.S. PATENT DOCUMENTS

D586,796	S	2/2009	Lee et al.	
D586,797	S	2/2009	Kawase et al.	
D587,701	S	3/2009	Yoon	
7,542,284	B1 *	6/2009	Wilson, Sr.	361/679.45
D596,633	S	7/2009	Kawase et al.	
D601,138	S *	9/2009	Solomon et al.	D14/315
D603,391	S	11/2009	Song et al.	
D603,392	S	11/2009	Jeong et al.	
D603,393	S	11/2009	Paek	
D603,394	S	11/2009	Lee	
D603,395	S	11/2009	Hong et al.	
D603,861	S	11/2009	Hong et al.	
D604,291	S *	11/2009	Andre et al.	D14/315
D606,067	S	12/2009	Yoon	
D606,068	S	12/2009	Hong et al.	
D606,069	S	12/2009	Heck et al.	
D606,070	S	12/2009	Heck et al.	
D606,534	S	12/2009	Hong et al.	
D608,777	S	1/2010	Yoon	
D611,468	S	3/2010	Yun et al.	
D614,614	S	4/2010	Yoon	
D614,615	S	4/2010	Yoon	
D622,268	S	8/2010	Hong et al.	
D626,543	S	11/2010	Hagen	
D627,341	S	11/2010	Yoon	
D627,773	S	11/2010	Paek	
D628,195	S	11/2010	Yoon	
D631,040	S	1/2011	Yoon et al.	
D631,471	S	1/2011	Jensen et al.	
D631,472	S	1/2011	Kawase et al.	
D631,473	S	1/2011	Lee et al.	
D631,878	S	2/2011	Jensen et al.	
D631,879	S	2/2011	Kawase	
D633,487	S	3/2011	Kim et al.	
D633,488	S	3/2011	Kim et al.	
D633,489	S	3/2011	Kim et al.	
D633,490	S	3/2011	Kim et al.	
2003/0151888	A1 *	8/2003	Chien et al.	361/680
2005/0018396	A1 *	1/2005	Nakajima et al.	361/683
2005/0041378	A1 *	2/2005	Hamada et al.	361/680

FOREIGN PATENT DOCUMENTS

KR	3005544080000	3/2010
KR	3005639120000	6/2010
KR	3005639130000	6/2010
KR	3005942330000	4/2011
KR	3005958550000	4/2011
KR	3006013110001	6/2011
KR	3006013130000	6/2011
KR	3006013160000	6/2011
KR	3006013170000	6/2011
KR	3006052790000	7/2011
KR	3006052810000	7/2011
KR	3006052820000	7/2011
KR	3006052830000	7/2011
KR	3006063210000	7/2011
KR	3006064090000	7/2011
KR	3006083610000	8/2011
KR	3006083630000	8/2011
KR	3006083710000	8/2011
KR	3006085180000	8/2011

OTHER PUBLICATIONS

U.S. Appl. No. 29/349,008, Applicant: Se-O Lee, et al., filed Mar. 2, 2010 entitled Net Book.
 U.S. Appl. No. 29/349,010, Applicant: Seung-Hyun Paek, et al., filed Mar. 2, 2010 entitled Net Book.
 U.S. Appl. No. 29/349,022, Applicant: Sang-Won Yoon, et al., filed Mar. 2, 2010 entitled Net Book.
 U.S. Appl. No. 29/349,397, Applicant: Atsushi Kawase, filed Mar. 31, 2010 entitled Net Book.
 U.S. Appl. No. 29/349,402, Applicant: Atsushi Kawase, filed Mar. 31, 2010 entitled Note Book.
 U.S. Appl. No. 29/349,403, Applicant: Atsushi Kawase, filed Mar. 31, 2010 entitled Net Book.
 U.S. Appl. No. 29/370,568, Applicant: Felix Heck, et al., filed Aug. 5, 2010 entitled Netbook Computer.
 U.S. Appl. No. 29/370,567, Applicant: Sang-Won Yoon, et al., filed Aug. 5, 2010 entitled Notebook Computer.
 U.S. Appl. No. 29/372,114, Applicant: Ji-Hyun Moon, et al., filed Oct. 15, 2010 entitled Notebook Computer.
 U.S. Appl. No. 29/370,053, Applicant: Chung-Ha Kim, et al., filed Feb. 23, 2011 entitled Notebook Computer.
 U.S. Appl. No. 29/390,400, Applicant: Lee, et al., filed Apr. 25, 2011 entitled Notebook Computer.
 U.S. Appl. No. 29/390,401, Applicant: Lee, et al., filed Apr. 25, 2011 entitled Notebook Computer.
 U.S. Appl. No. 29/390,415, Applicant: Kim, et al., filed Apr. 25, 2011 entitled Notebook Computer.
 U.S. Appl. No. 29/390,437, Applicant: Kim, et al., filed Apr. 25, 2011 entitled Notebook Computer.
 U.S. Appl. No. 29/390,418, Applicant: Kim, et al., filed Apr. 25, 2011 entitled Notebook Computer.
 U.S. Appl. No. 29/390,440, Applicant: Kim, et al., filed Apr. 25, 2011 entitled Cradle for Notebook Computer.
 U.S. Appl. No. 29/390,448, Applicant: Lee, et al., filed Apr. 25, 2011 entitled Battery for Notebook Computer.
 U.S. Appl. No. 29/390,450, Applicant: Lee, et al., filed Apr. 25, 2011 entitled Netbook Computer.
 U.S. Appl. No. 29/390,455, Applicant: Kim, et al., filed Apr. 25, 2011 entitled Netbook Computer.
 U.S. Appl. No. 29/390,465, Applicant: Lee, et al., filed Apr. 25, 2011 entitled Notebook Computer.
 U.S. Appl. No. 29/393,979, Applicant: Park, et al., filed Jun. 10, 2011 entitled Notebook Computer.
 U.S. Appl. No. 29/393,980, Applicant: Park, et al., filed Jun. 10, 2011 entitled Notebook Computer.
 U.S. Appl. No. 29/393,983, Applicant: Park, et al., filed Jun. 10, 2011 entitled Notebook Computer.
 U.S. Appl. No. 29/396,993, Applicant: Kim, et al., filed Jul. 11, 2011 entitled Notebook Computer.
 U.S. Appl. No. 29/397,032, Applicant: Kim, et al., filed Jul. 11, 2011 entitled Notebook Computer.
 U.S. Appl. No. 29/397,034, Applicant: Kim, et al., filed Jul. 11, 2011 entitled Notebook Computer.
 U.S. Appl. No. 29/397,064, Applicant: Fukusawa, et al., filed Jul. 11, 2011 entitled Notebook Computer.
 U.S. Appl. No. 29/397,041, Applicant: Ryu et al., filed Jul. 11, 2011 entitled Netbook Computer.

* cited by examiner

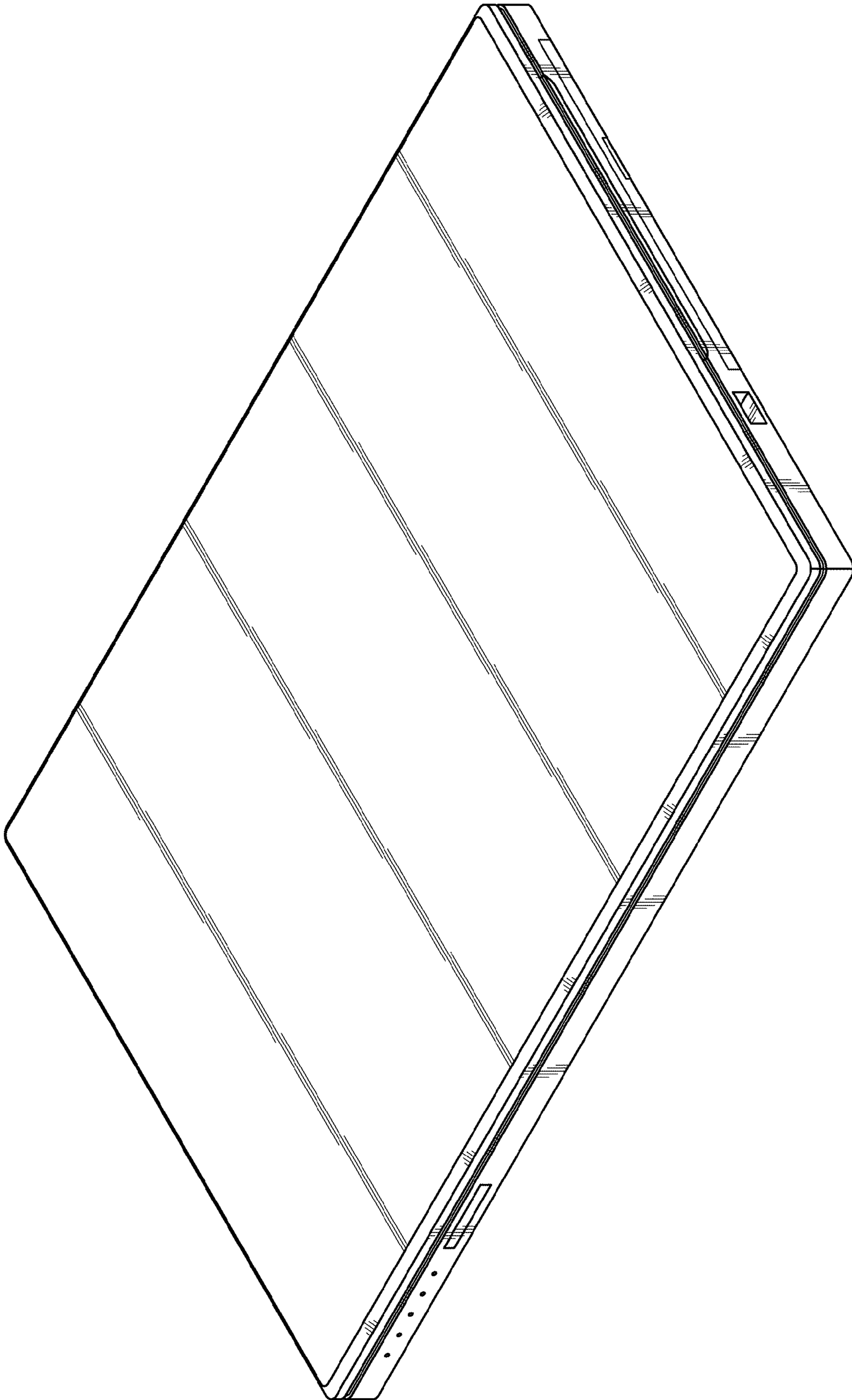

FIG.1

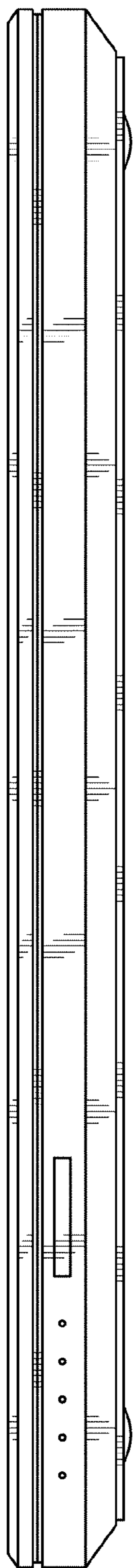

FIG. 2

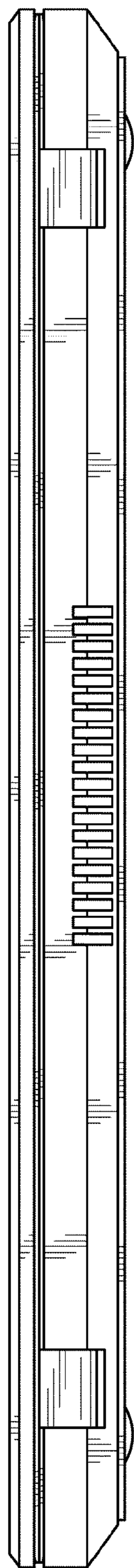

FIG. 3

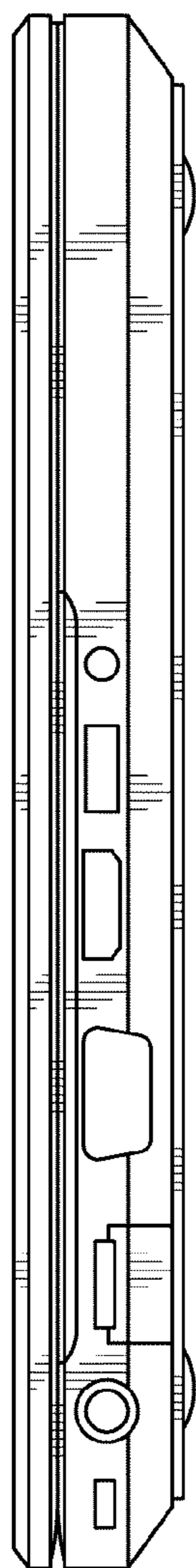

FIG. 4

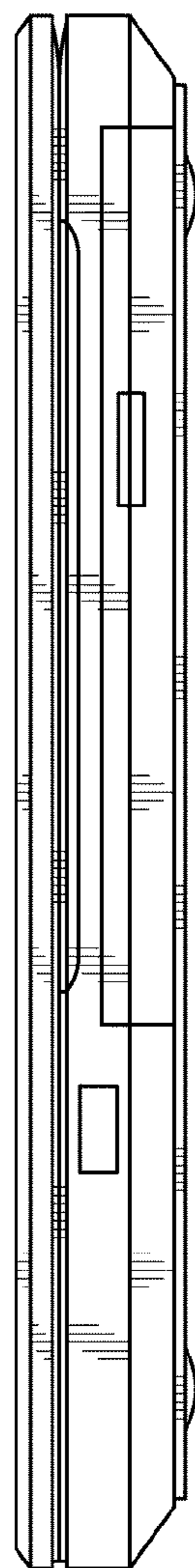

FIG. 5

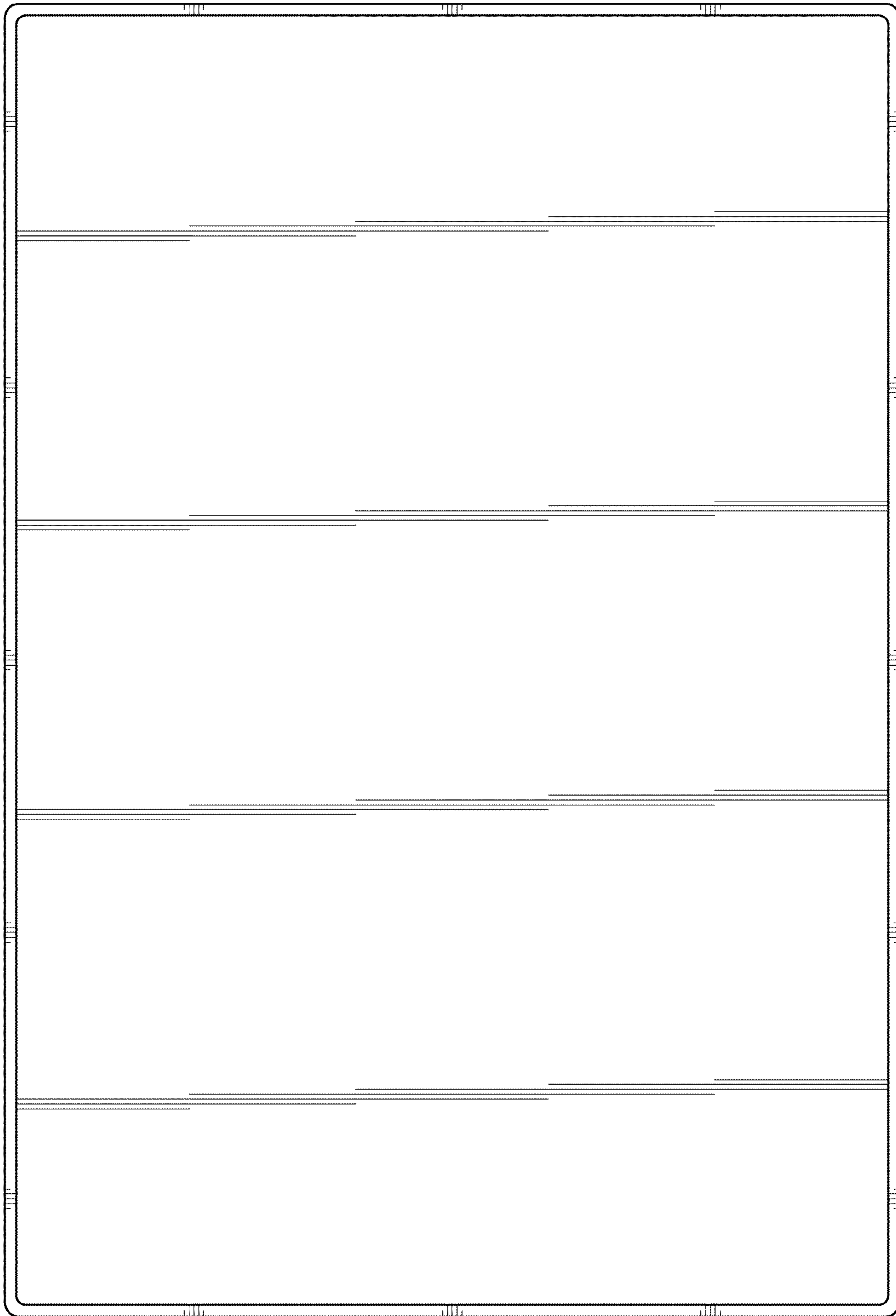

FIG. 6

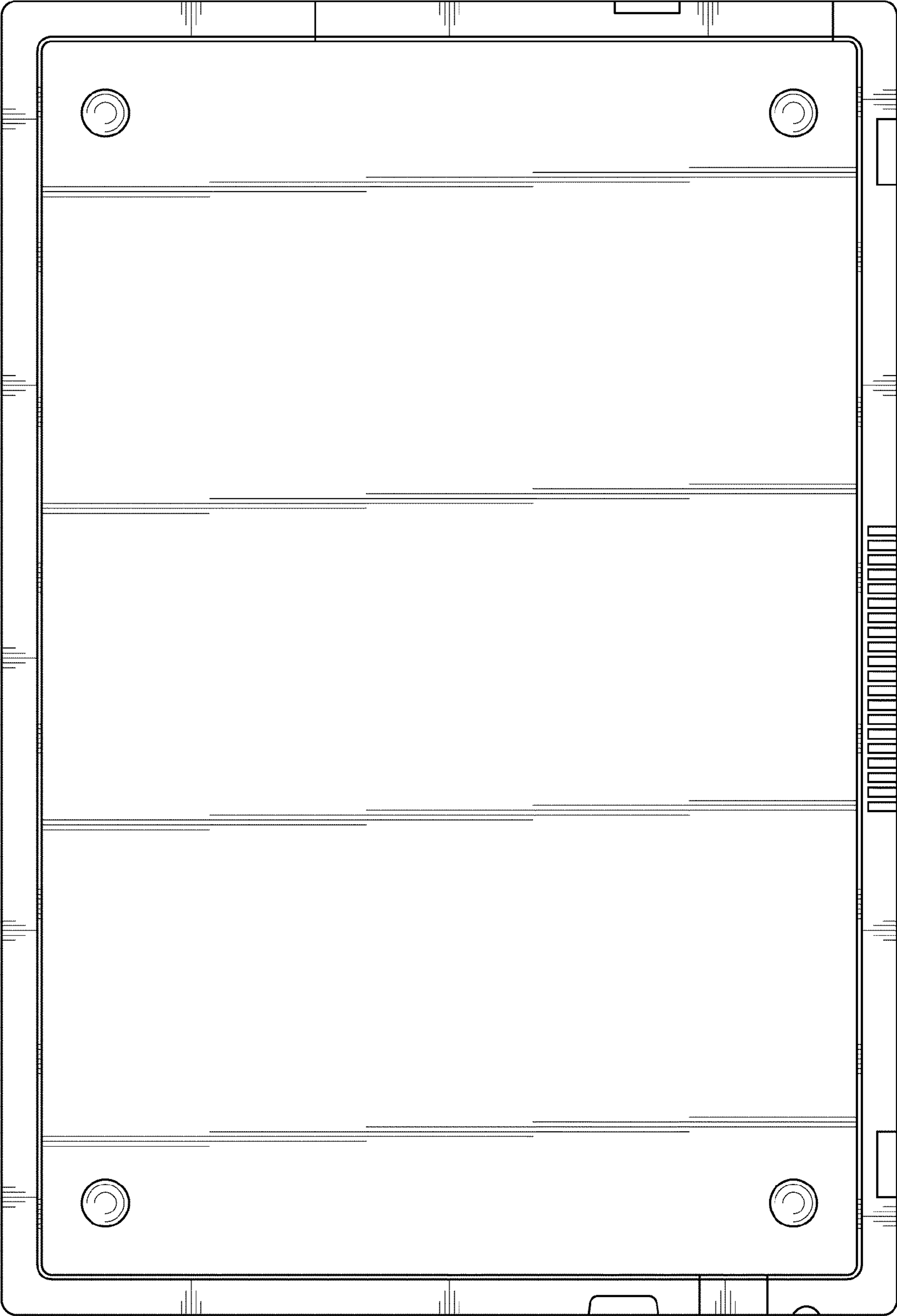

FIG. 7