



US00D652383S

(12) **United States Design Patent**
Akahori

(10) **Patent No.:** **US D652,383 S**
(45) **Date of Patent:** **** Jan. 17, 2012**

(54) **PLUG**

(75) Inventor: **Yasuhiro Akahori**, Nishinomiya (JP)

(73) Assignee: **Panasonic Electric Works Co., Ltd.**,
Kadoma (JP)

(**) Term: **14 Years**

(21) Appl. No.: **29/368,266**

(22) Filed: **Aug. 20, 2010**

(30) **Foreign Application Priority Data**

Feb. 23, 2010 (JP) 2010-004195

(51) **LOC (9) Cl.** **13-03**

(52) **U.S. Cl.** **D13/138.2**

(58) **Field of Classification Search** D13/138.1,
D13/138.2, 139.1–139.8, 137.1–137.4, 133,
D13/107, 108, 110, 146, 147, 154, 174, 177;
D8/353, 350; 363/15, 34, 146; 439/93, 105,
439/106, 535, 620.15, 620.21, 620.3, 620.31,
439/907, 908, 919, 650, 651, 652, 653, 654,
439/655, 692; 174/494, 53, 55, 59, 66; 320/111,
320/114, 115; 307/150, 151

See application file for complete search history.

(56) **References Cited**

U.S. PATENT DOCUMENTS

D217,614 S * 5/1970 Kress D13/138.2
5,192,231 A * 3/1993 Dolin, Jr. 439/620.21
D361,981 S * 9/1995 Okamoto D13/138.2
D380,732 S * 7/1997 Saunders D13/137.1

D401,904 S * 12/1998 Burke et al. D13/138.2
D407,371 S * 3/1999 Pudims et al. D13/138.2
D475,349 S * 6/2003 Guizard et al. D13/137.1
D484,460 S * 12/2003 Cheng et al. D13/137.4
D511,746 S * 11/2005 Lu D13/110
D554,585 S * 11/2007 Nazar D13/110
D595,230 S * 6/2009 Peck D13/139.1
D604,243 S * 11/2009 Thorner D13/133
D633,871 S * 3/2011 Akahori D13/139.4

* cited by examiner

Primary Examiner — Angela J Lee

(74) *Attorney, Agent, or Firm* — Marvin A. Motsenbocker;
Mots Law, PLLC

(57) **CLAIM**

The ornamental design for a plug, as shown and described.

DESCRIPTION

FIG. 1 is a perspective view of the plug;
FIG. 2 is a front view thereof;
FIG. 3 is a right side view thereof;
FIG. 4 is a left side view thereof;
FIG. 5 is a top plan view thereof;
FIG. 6 is a rear view thereof;
FIG. 7 is a bottom view thereof;
FIG. 8 is a cross-sectional view at cross-section 8-8 of FIG. 5;
and,
FIG. 9 is a sectional view thereof, but shown with environ-
ment in broken lines.
The environment and portions of the plug shown in broken
lines form no part of the claimed design.

1 Claim, 9 Drawing Sheets

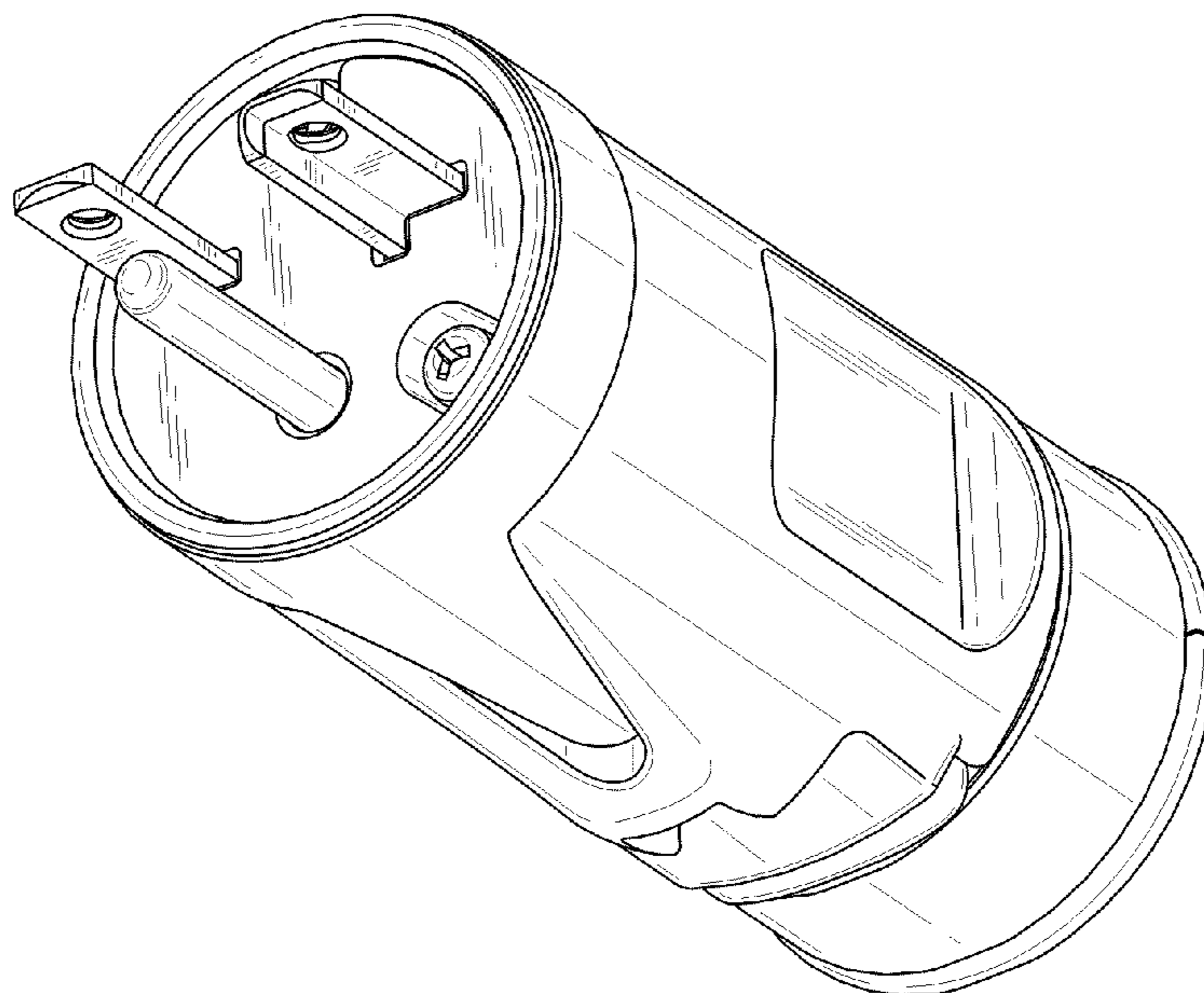

Fig.1

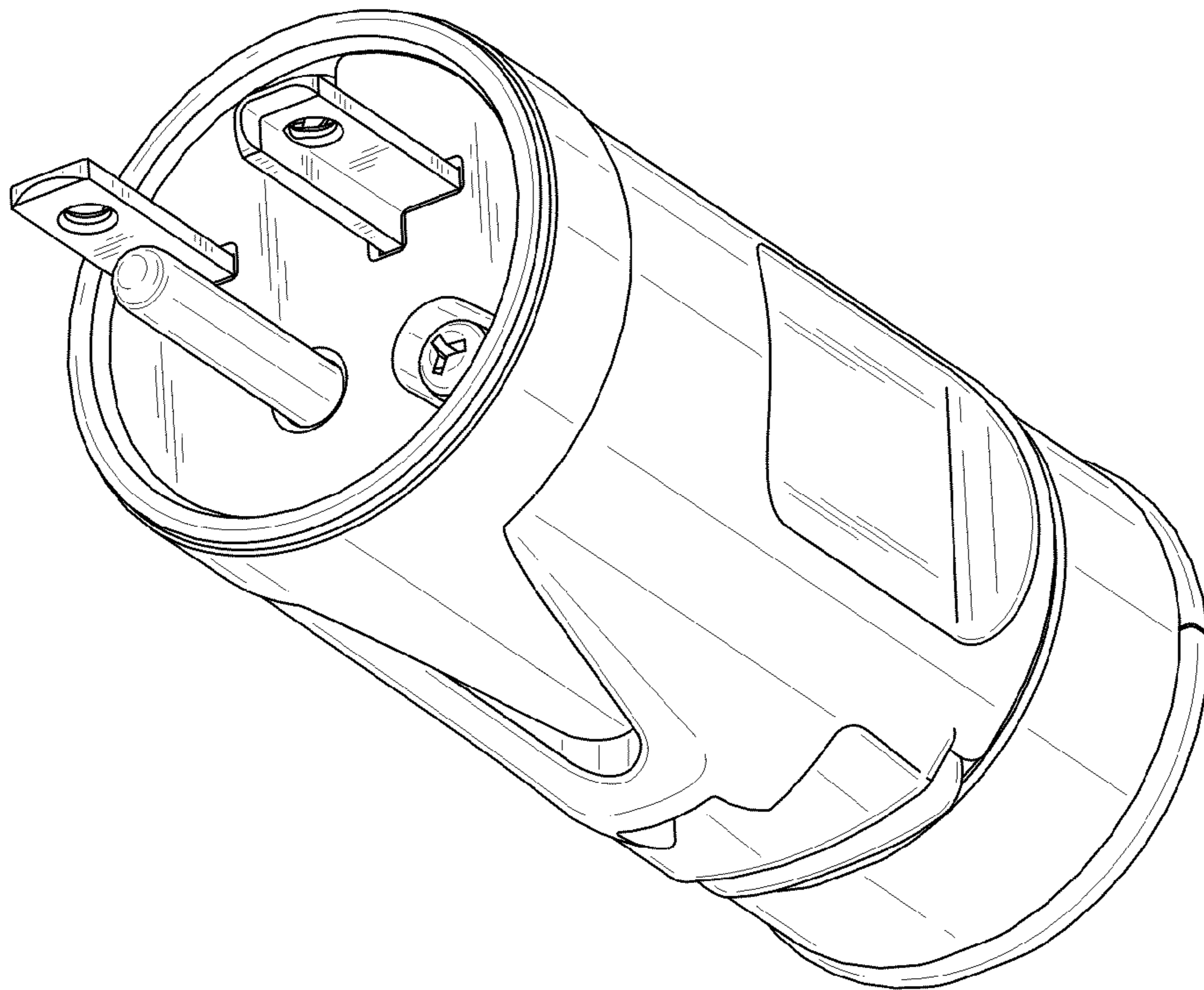

Fig.2

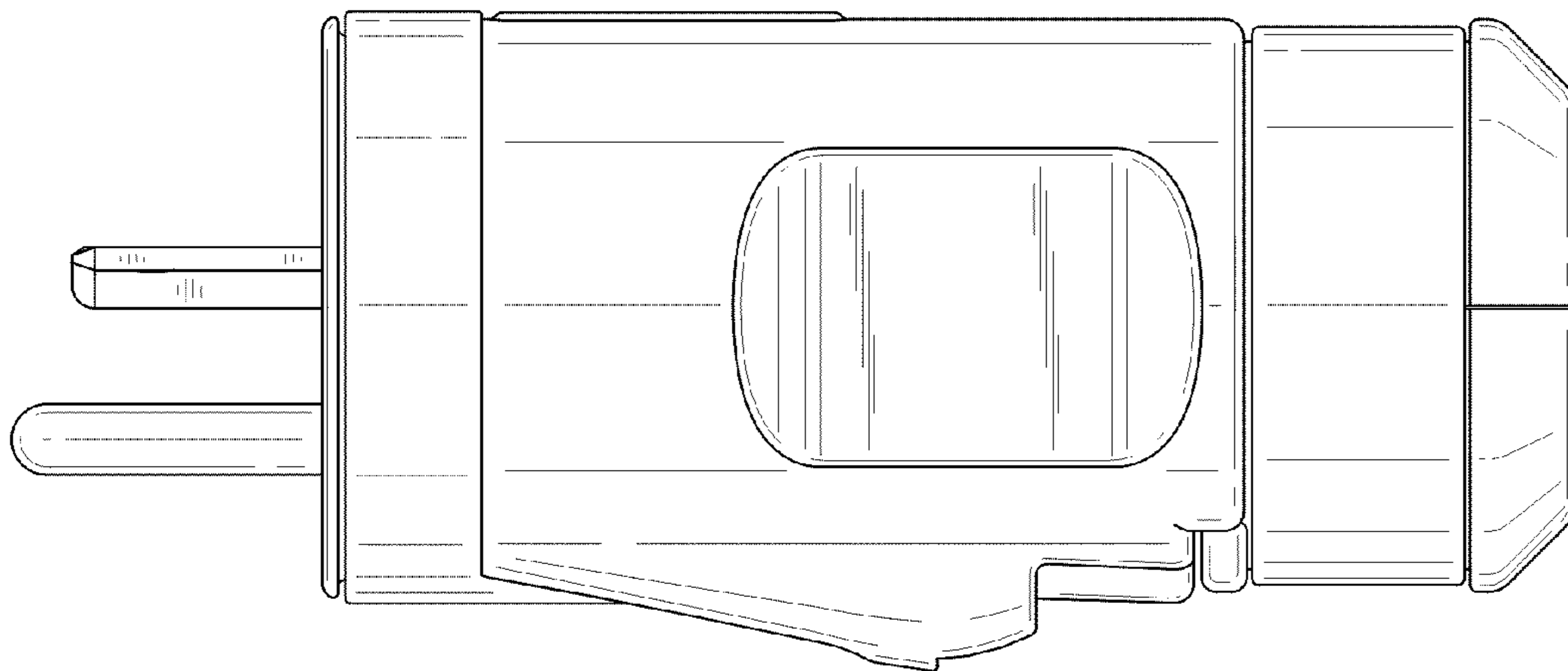

Fig.3

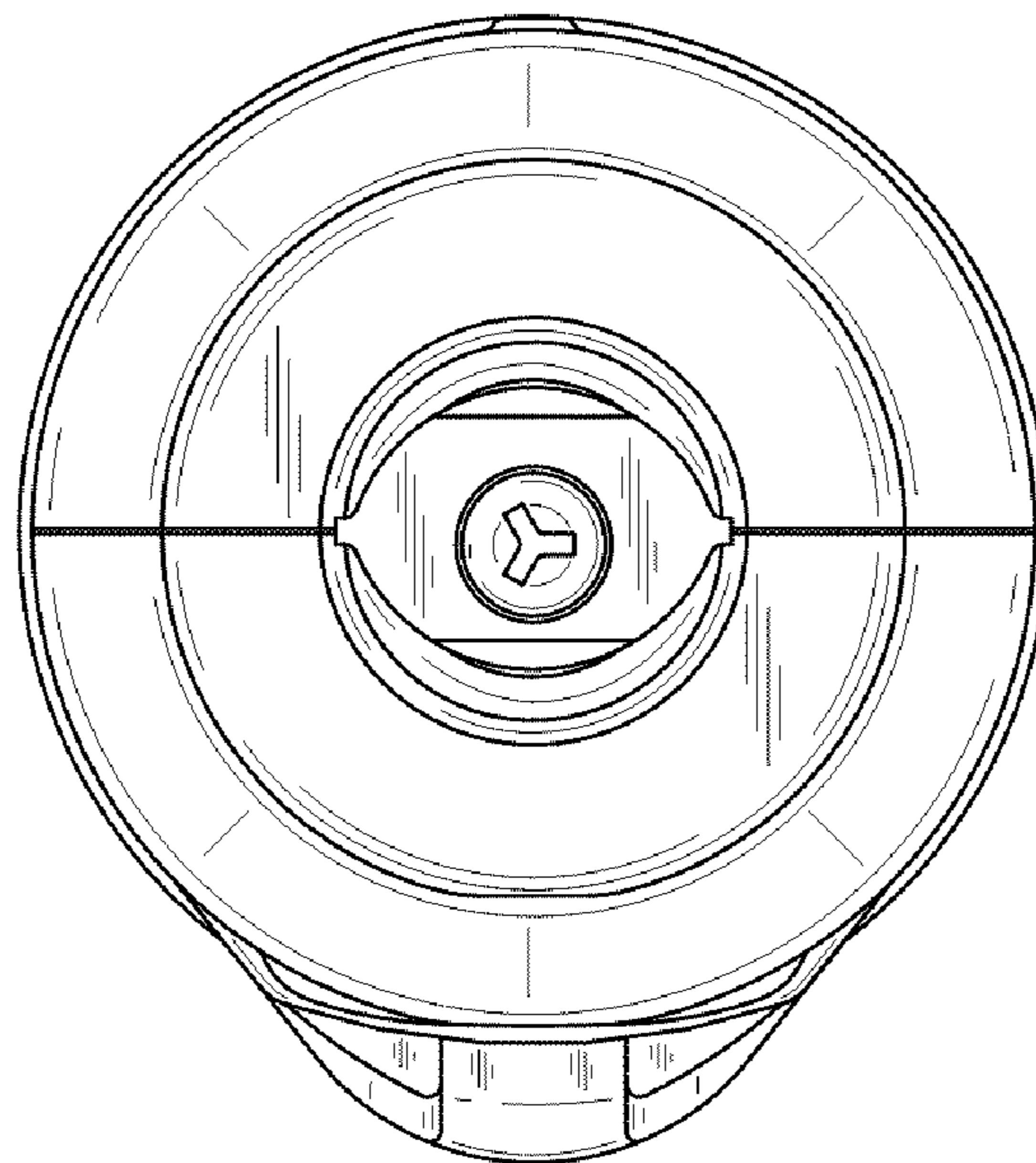

Fig.4

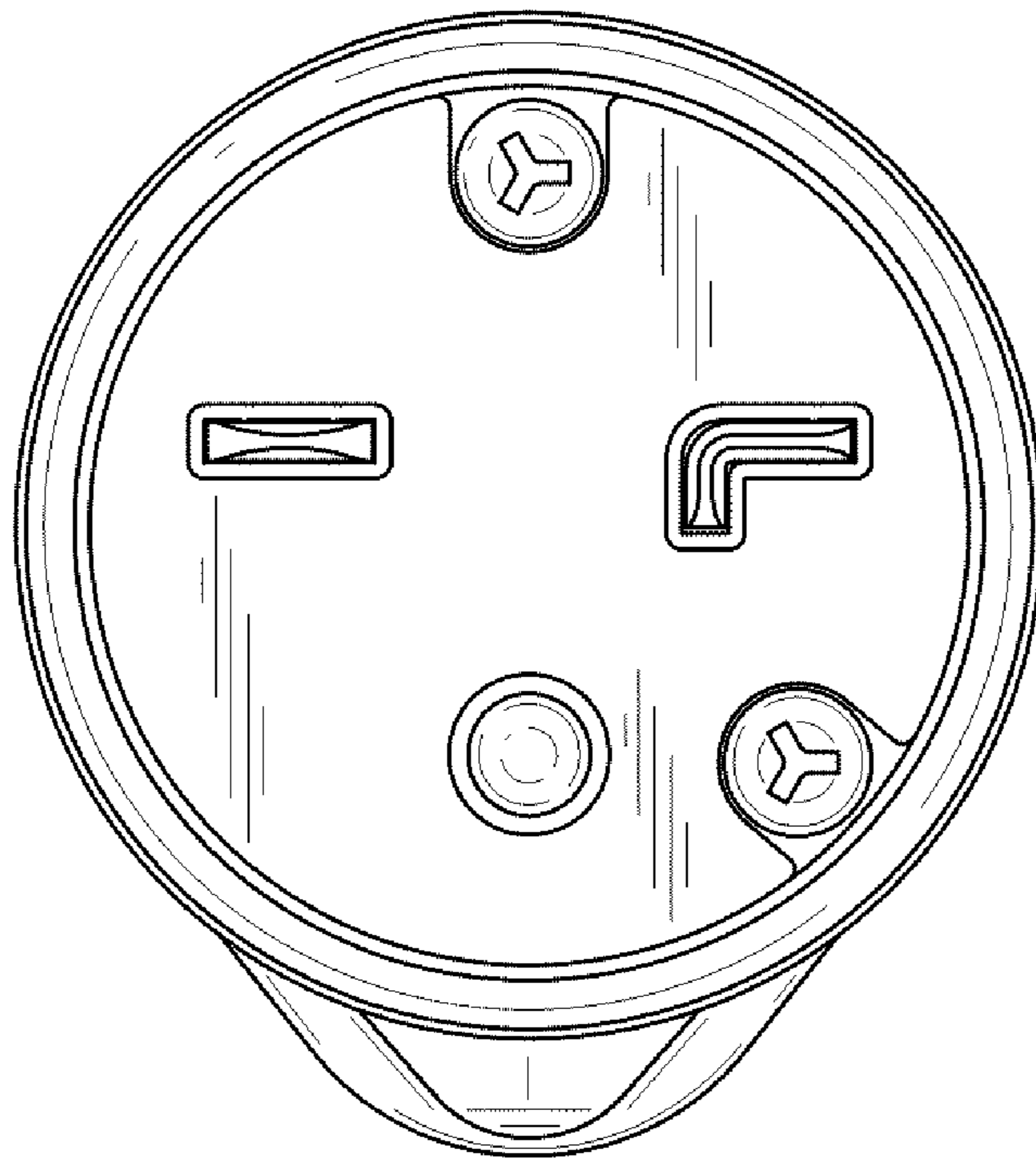

Fig.5

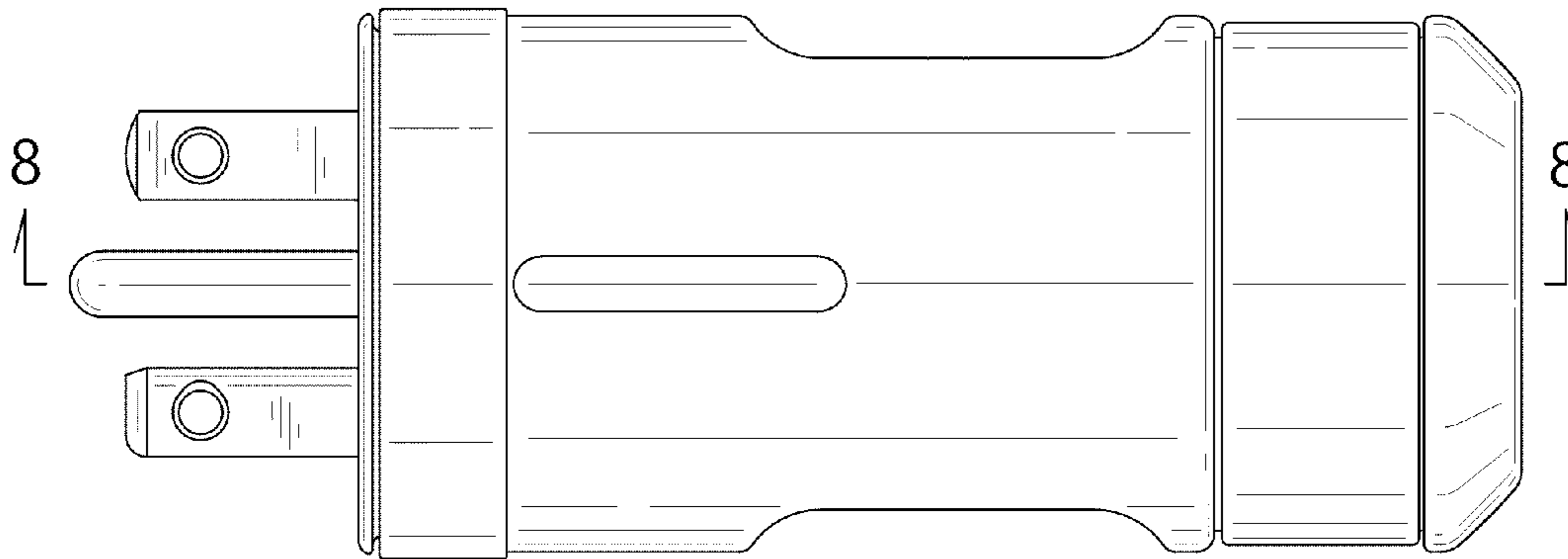

Fig.6

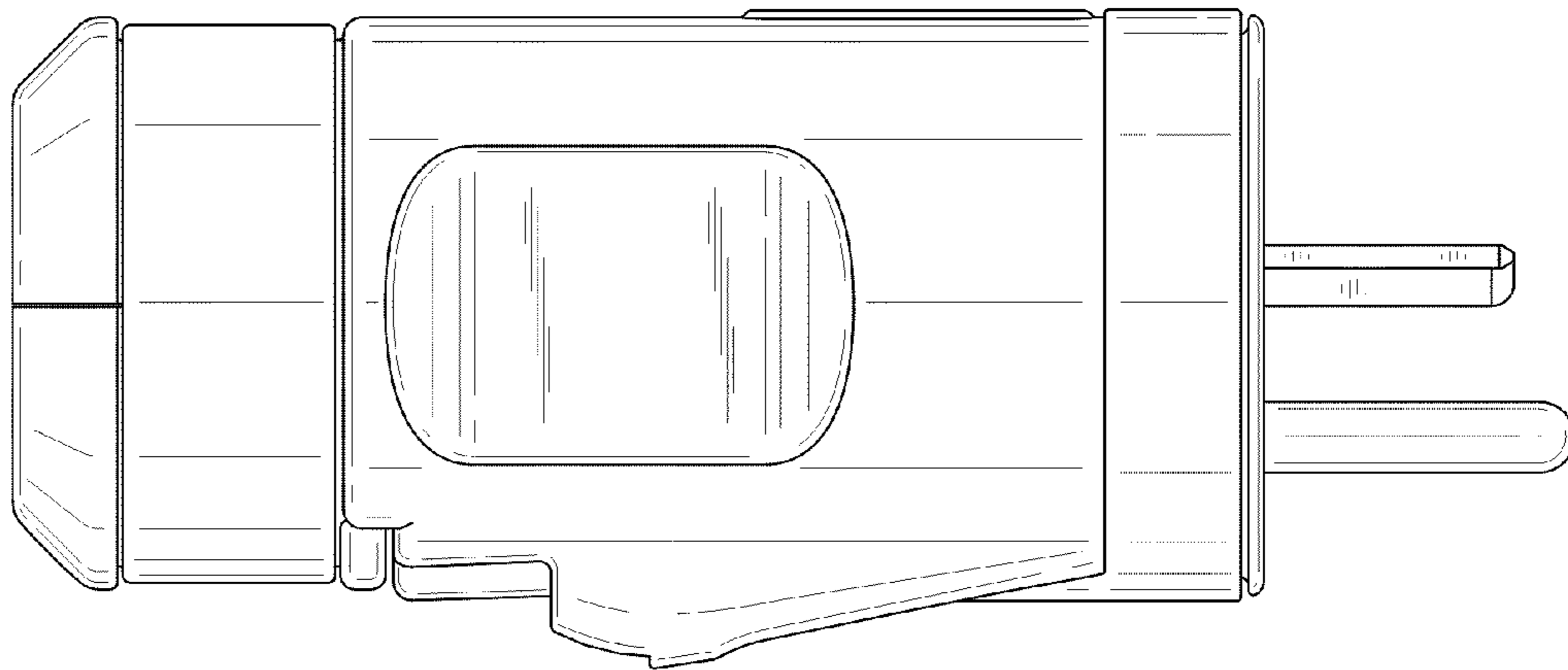

Fig.7

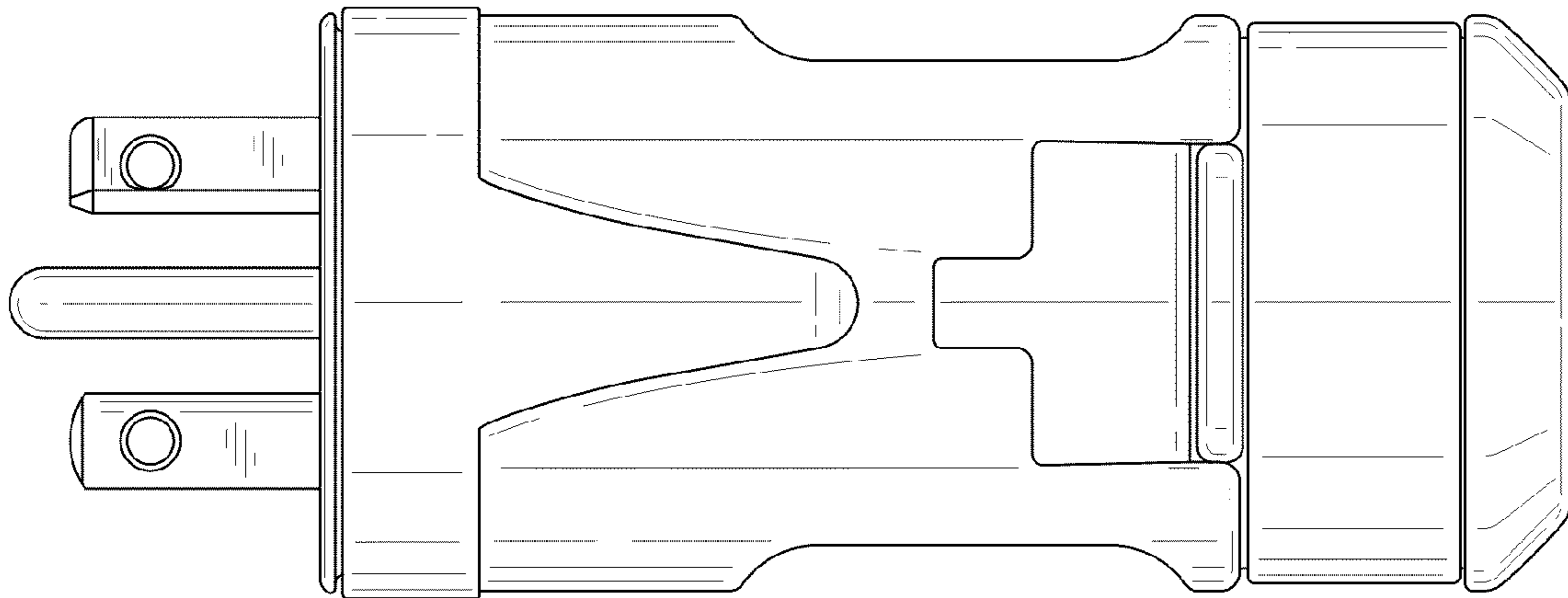

Fig.8

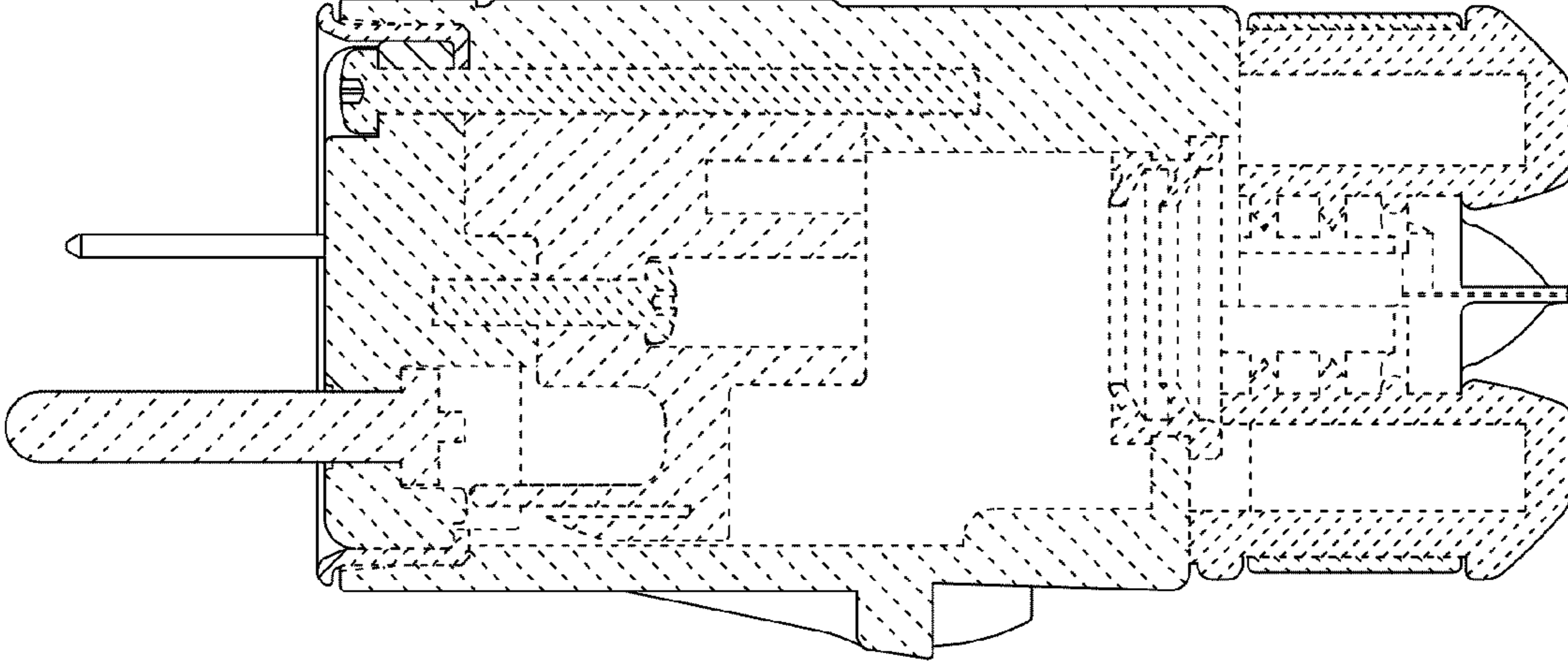

Fig.9

