



US00D652191S

(12) **United States Design Patent**
Arcati

(10) **Patent No.:** **US D652,191 S**
(45) **Date of Patent:** **** Jan. 10, 2012**

(54) **HOSE REEL ACCESSORY TRAY TO PULL
HANDLE INTERFACE**

(75) Inventor: **Peter Arcati**, Dillsburg, PA (US)

(73) Assignee: **Ames True Temper, Inc.**, Camp Hill, PA
(US)

(**) Term: **14 Years**

(21) Appl. No.: **29/389,240**

(22) Filed: **Apr. 8, 2011**

(51) **LOC (9) Cl.** **12-02**

(52) **U.S. Cl.** **D34/24**

(58) **Field of Classification Search** D34/12-27;
242/403.1, 395; 280/33.991, 33.992, 47.18,
280/47.26, 47.34; D8/356, 359
See application file for complete search history.

(56) **References Cited**

U.S. PATENT DOCUMENTS

3,286,502	A	11/1966	Cogan	
RE32,510	E *	9/1987	Tisbo et al.	137/355.27
D328,173	S *	7/1992	Nelson	D34/26
D349,039	S *	7/1994	Goodman et al.	D8/359
D352,149	S *	11/1994	Nelson et al.	D34/26
D390,095	S	2/1998	Spear et al.	
D390,315	S *	2/1998	Spear et al.	D34/24
D395,111	S	6/1998	Spear	
D409,813	S *	5/1999	Tisbo et al.	D34/24
D417,538	S *	12/1999	Tisbo et al.	D34/24
D418,270	S *	12/1999	Tisbo et al.	D34/24
6,386,473	B1 *	5/2002	Vitaletti	242/403.1
D503,837	S *	4/2005	Alkalay	D34/14
2004/0188558	A1 *	9/2004	Moon et al.	242/403.1

OTHER PUBLICATIONS

AMAZON.COM—Advertisement, Image of Suncast SHA150B
150-Foot Capacity Garden Hose, Jul. 22, 2010, 1 page.

AMAZON.COM—Advertisement, Image of Suncast HRC200
Hosemobile 225-Foot Hose Reel Cart, Jul. 22, 2010, 1 page.

* cited by examiner

Primary Examiner — Cynthia Ramirez

(74) *Attorney, Agent, or Firm* — Eckert Seamans Cherin &
Mellot, LLC; David C. Jenkins, Esquire

(57) **CLAIM**

The ornamental design for hose reel accessory tray to pull
handle interface, as shown and described.

DESCRIPTION

FIG. 1 is an isometric view of the hose reel accessory tray to
pull handle interface;

FIG. 2 is a front view of the hose reel accessory tray to pull
handle interface;

FIG. 3 is a back view of the hose reel accessory tray to pull
handle interface;

FIG. 4 is a top view of the hose reel accessory tray to pull
handle interface;

FIG. 5 is a bottom view of the hose reel accessory tray to pull
handle interface;

FIG. 6 is a right side view of the hose reel accessory tray to
pull handle interface; and,

FIG. 7 is a left side view of the hose reel accessory tray to pull
handle interface.

The broken lines in the figures are included for the purpose of
illustrating portions of the hose reel and form no part of the
claimed design.

1 Claim, 7 Drawing Sheets

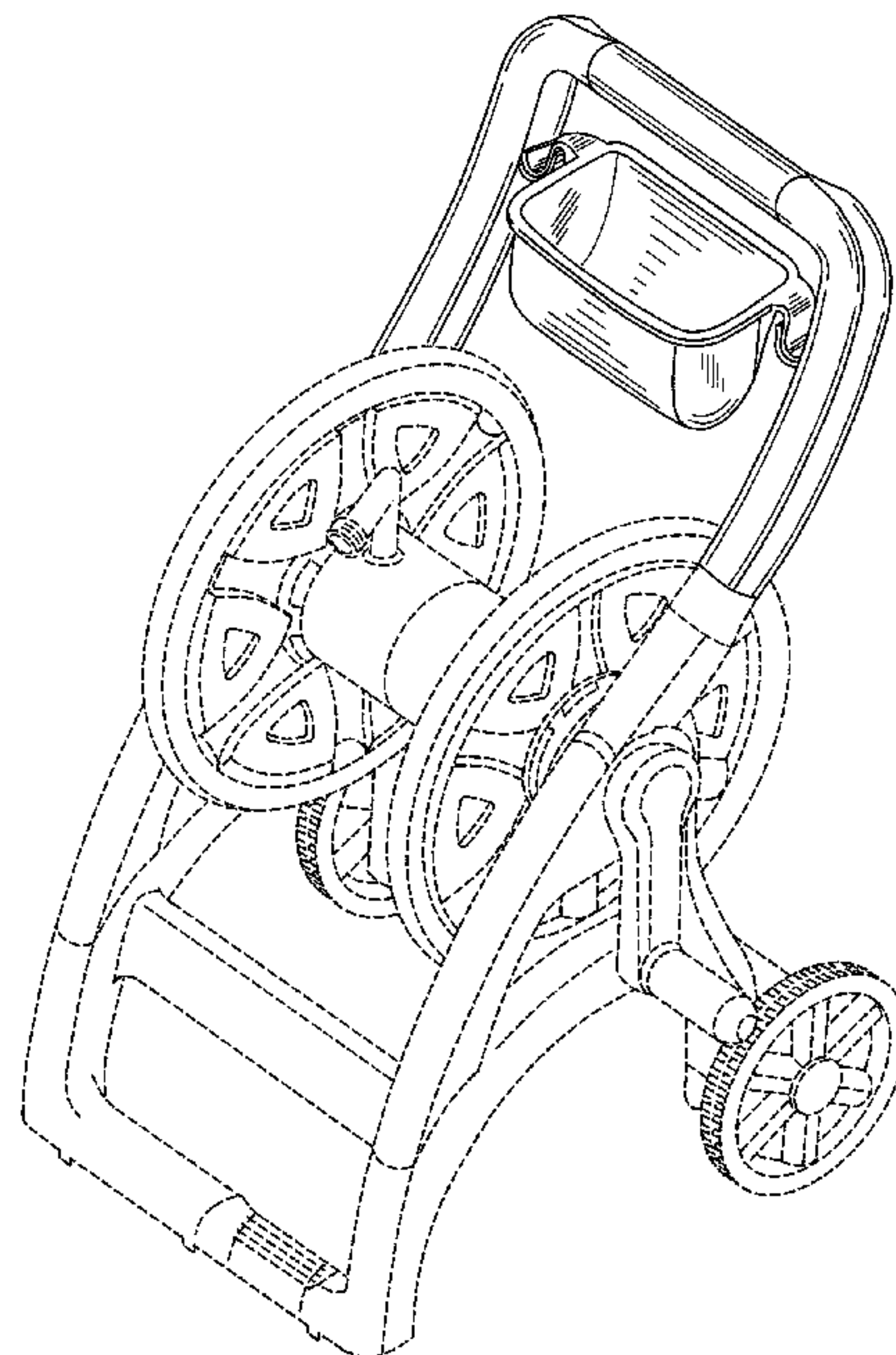

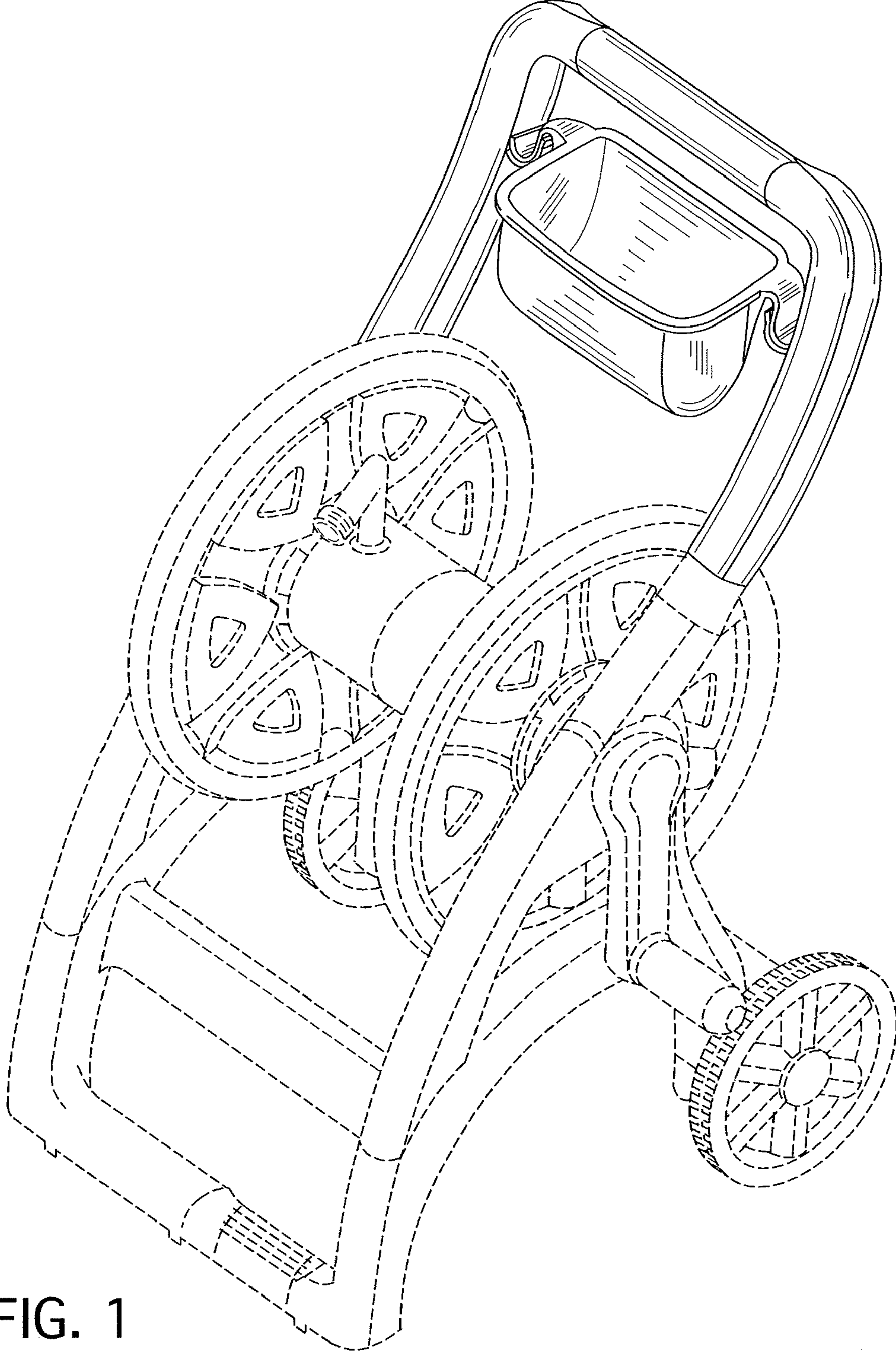

FIG. 1

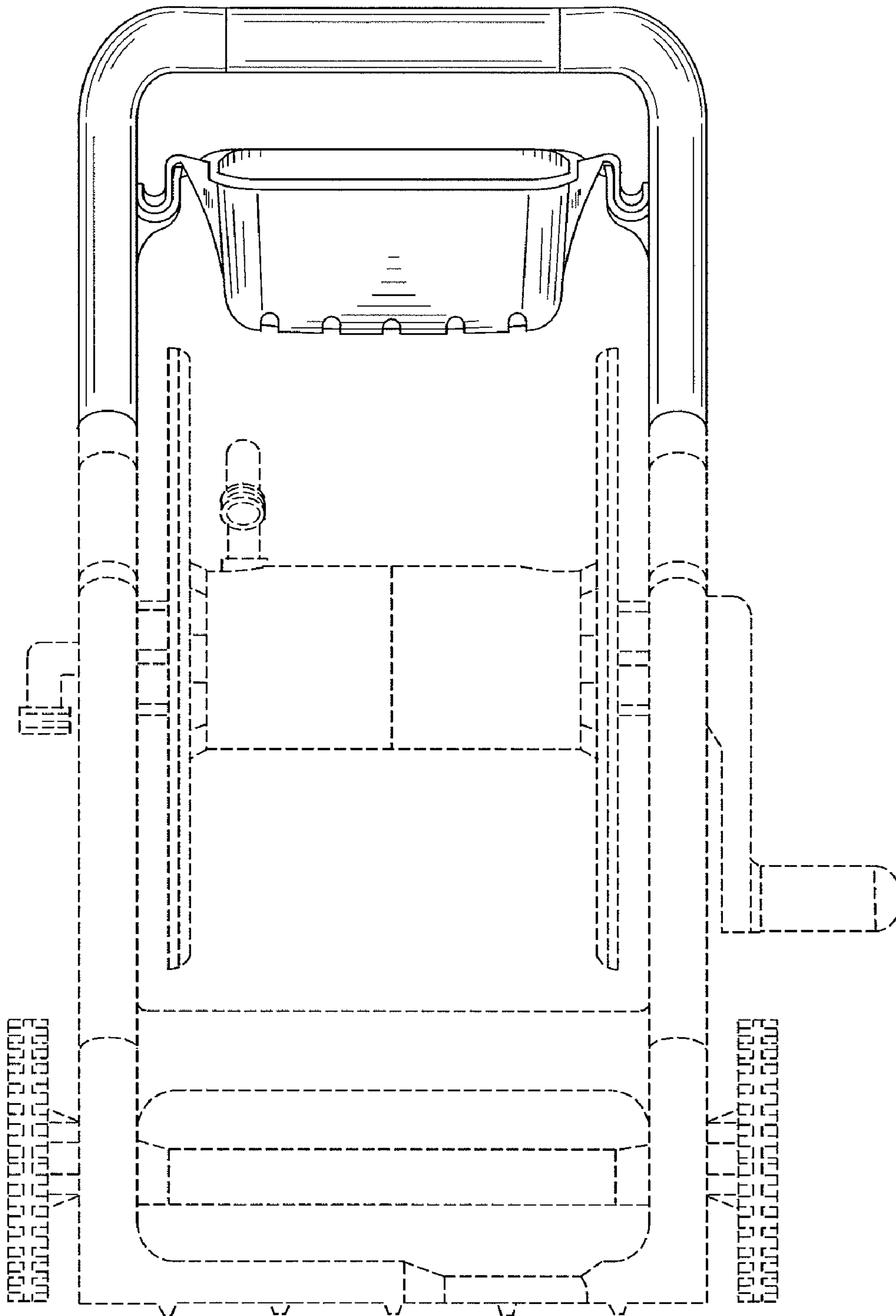

FIG. 2

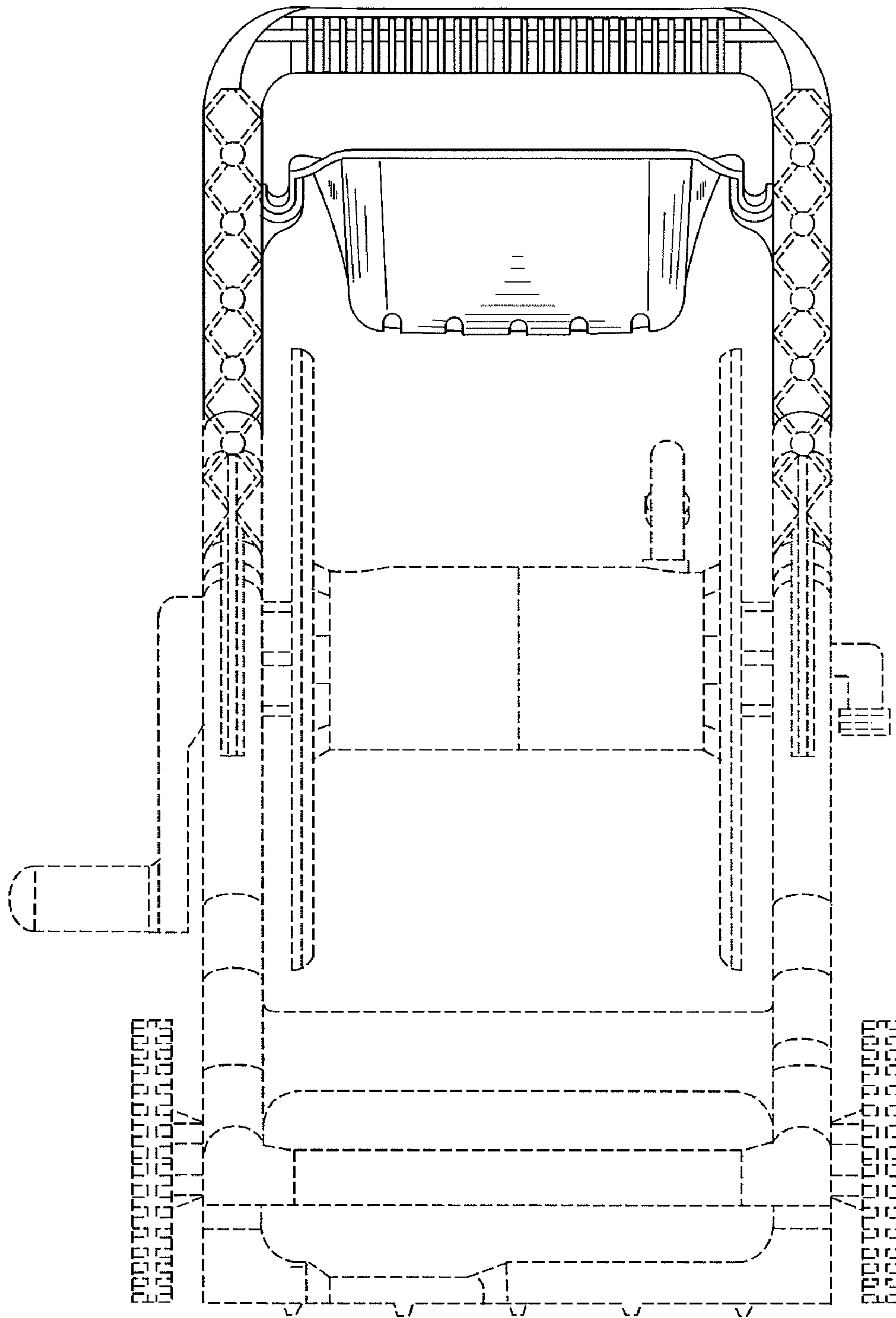

FIG. 3

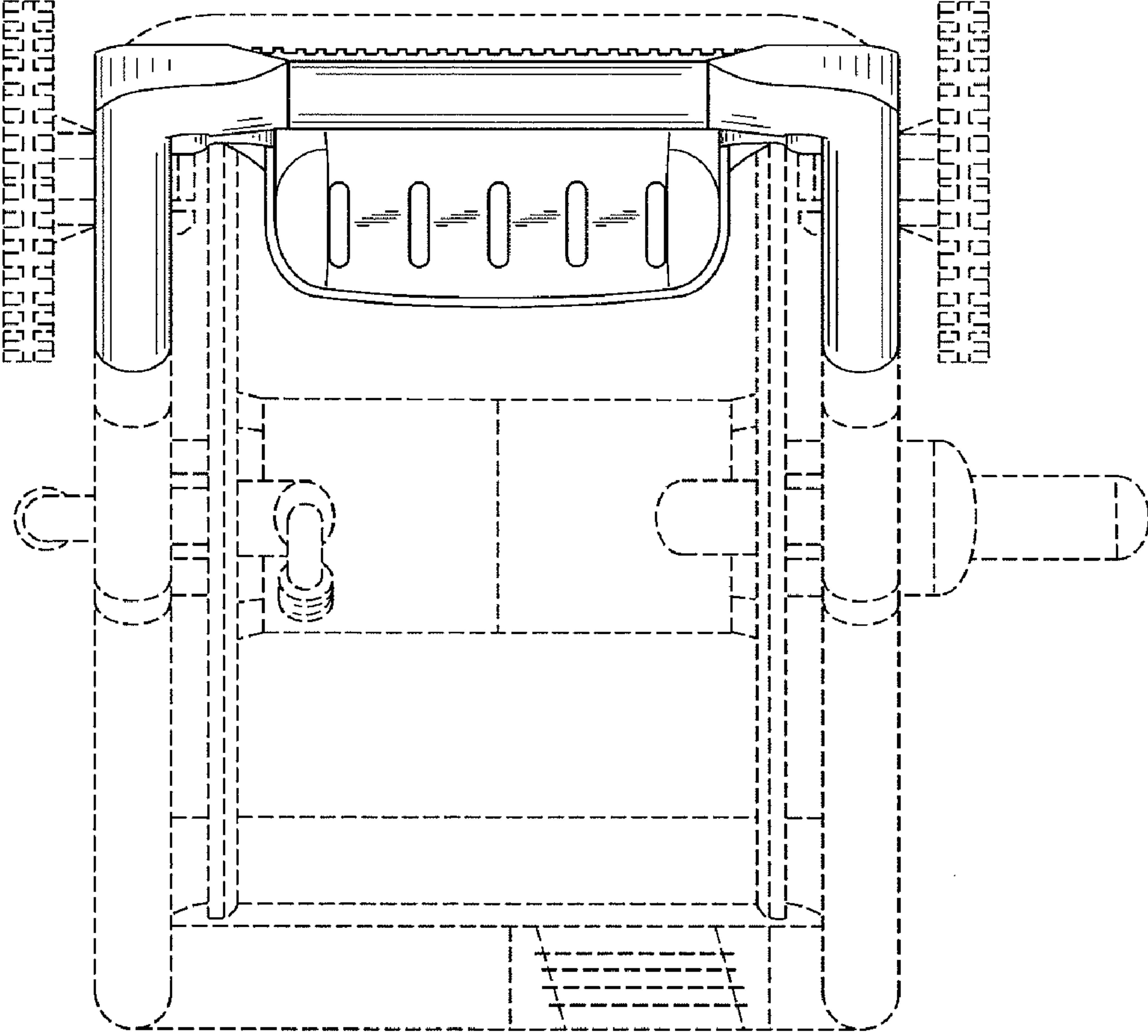

FIG. 4

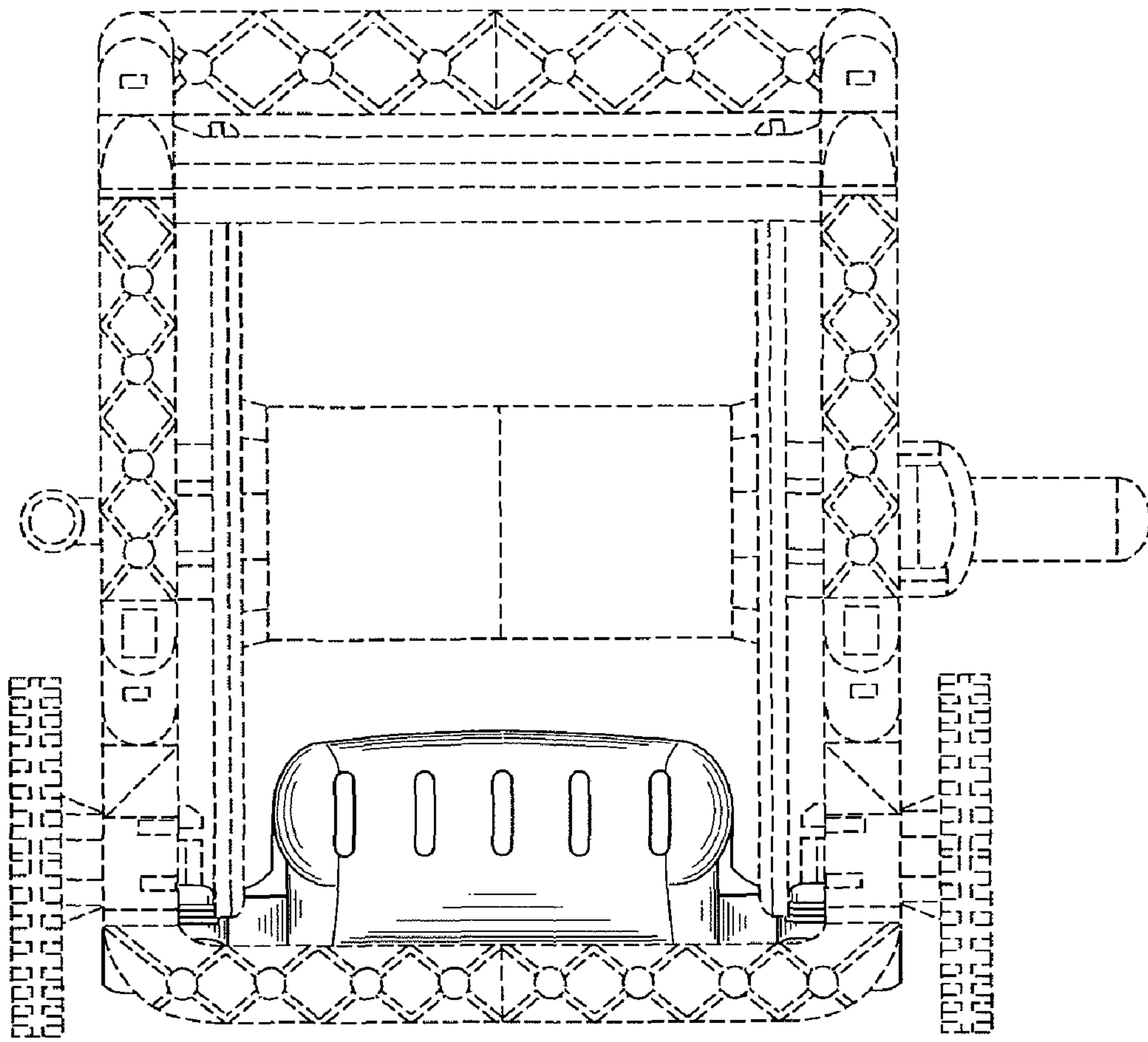

FIG. 5

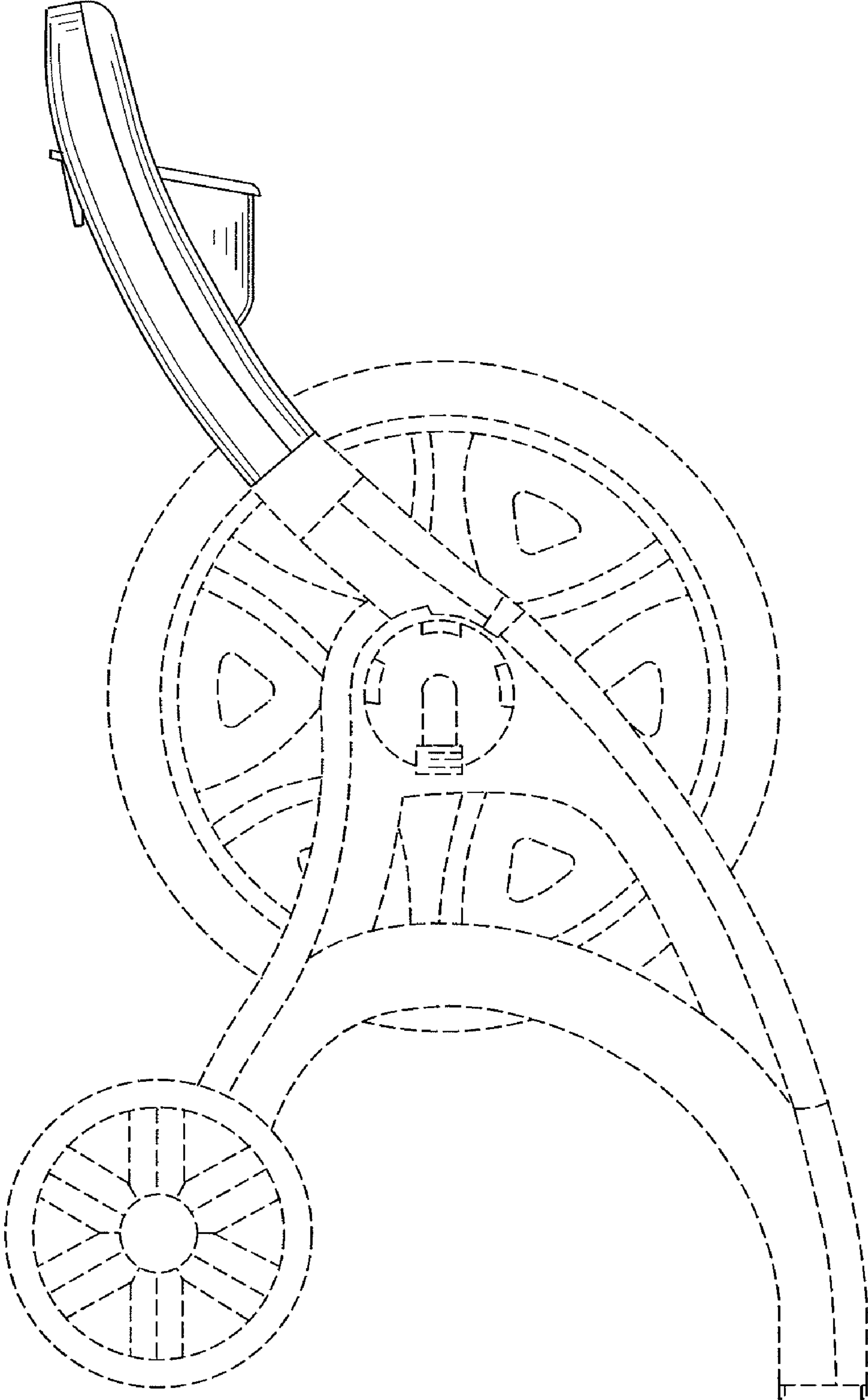

FIG. 6

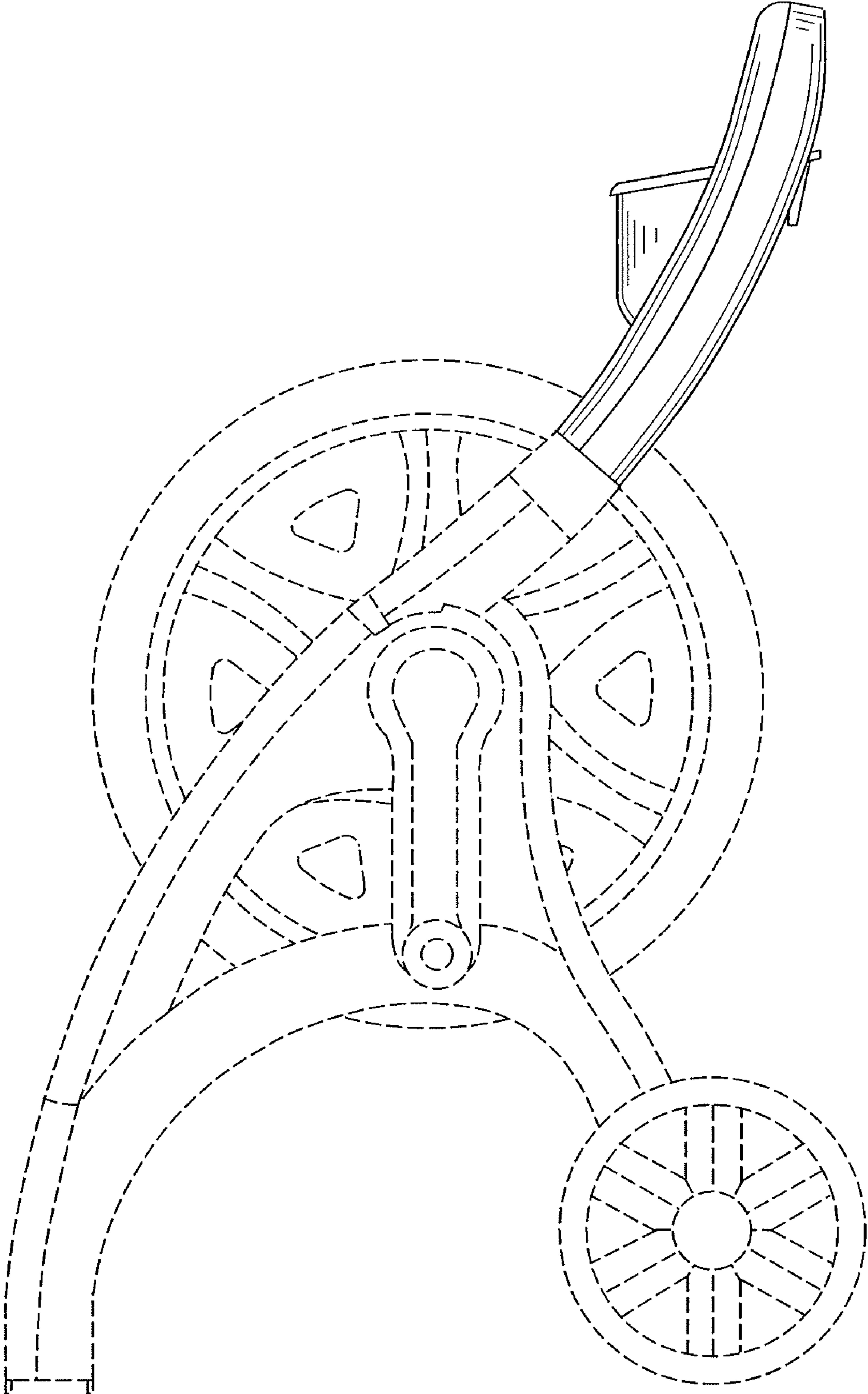

FIG. 7