



US00D652131S

(12) **United States Design Patent**
Ritzenhoff

(10) **Patent No.:** **US D652,131 S**
(45) **Date of Patent:** **** Jan. 10, 2012**

(54) **CONTAINER FOR STICK FRAGRANCE
DIFFUSERS**

(75) Inventor: **Andreas Ritzenhoff**, Marburg (DE)

(73) Assignee: **Seidel GmbH & Co. KG**, Marburg (DE)

(**) Term: **14 Years**

(21) Appl. No.: **29/365,703**

(22) Filed: **Jul. 13, 2010**

(30) **Foreign Application Priority Data**

Jan. 13, 2010 (DE) 00165617-4-0005

(51) **LOC (9) Cl.** **28-99**

(52) **U.S. Cl.** **D23/366**

(58) **Field of Classification Search** D23/355-369;
D28/5, 6; 261/DIG. 17, DIG. 42, DIG. 65,
261/DIG. 88, DIG. 89; 392/386, 390, 391,
392/392, 393, 394, 395; 239/34, 35, 44-47,
239/50, 53, 56, 60, 145, 326

See application file for complete search history.

(56) **References Cited**

U.S. PATENT DOCUMENTS

D434,481 S * 11/2000 Bornstein et al. D23/366
7,055,764 B1 * 6/2006 Martinez et al. 239/145
D596,732 S 7/2009 Butler et al.
D605,746 S 12/2009 Butler et al.
D620,574 S 7/2010 Jorgensen

7,819,336 B2 * 10/2010 Newman 239/44
2008/0217425 A1 9/2008 Butler et al.
2008/0308648 A1 12/2008 Pesu
2009/0039174 A1 2/2009 Gaines et al.
2009/0101729 A1 4/2009 Newman

* cited by examiner

Primary Examiner — Sandra Snapp

(74) *Attorney, Agent, or Firm* — Griffin & Szipl, P.C.

(57) **CLAIM**

The ornamental design for a container for stick fragrance diffusers, as shown and described.

DESCRIPTION

FIG. 1 is a front view of the container for stick fragrance diffusers of the present invention.

FIG. 2 is a plan view of the container of the present invention.

FIG. 3 is a front perspective view of the container of the present invention.

FIG. 4 is a rear perspective view of the container of the present invention.

FIG. 5 is a rear perspective view of the container of the present invention taken at a slightly different angle than in FIG. 3.

FIG. 6 is an oblique perspective view of the container of the present invention; and,

FIG. 7 is a bottom view of the container of the present invention.

The broken lines shown in the drawings are for illustrative purposes only and form no part of the claimed design.

1 Claim, 7 Drawing Sheets

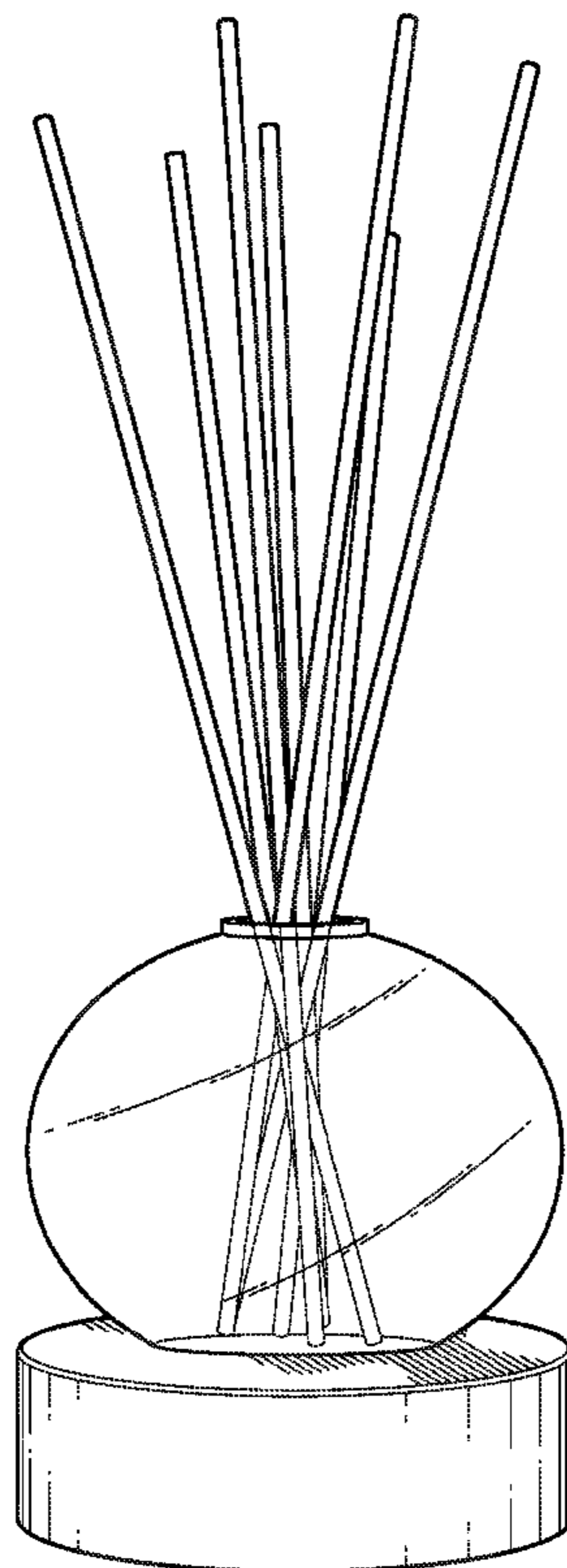

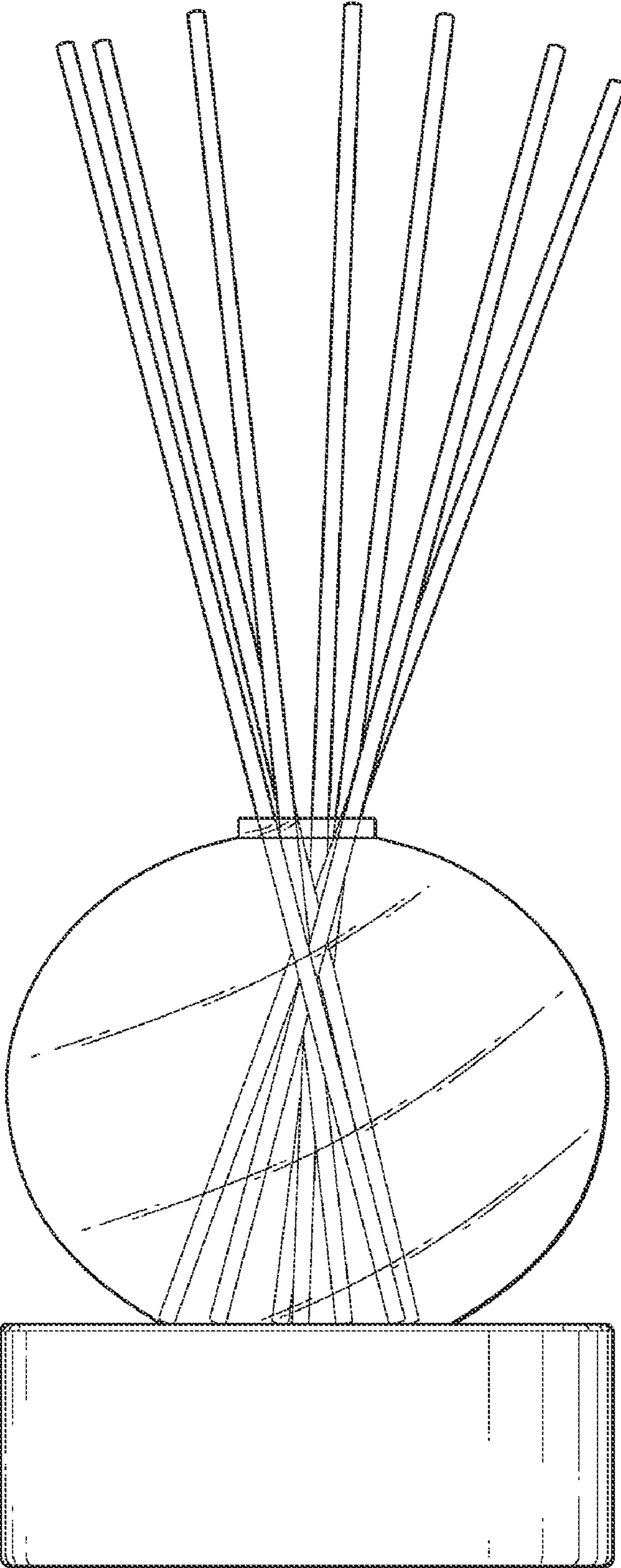

FIG. 1

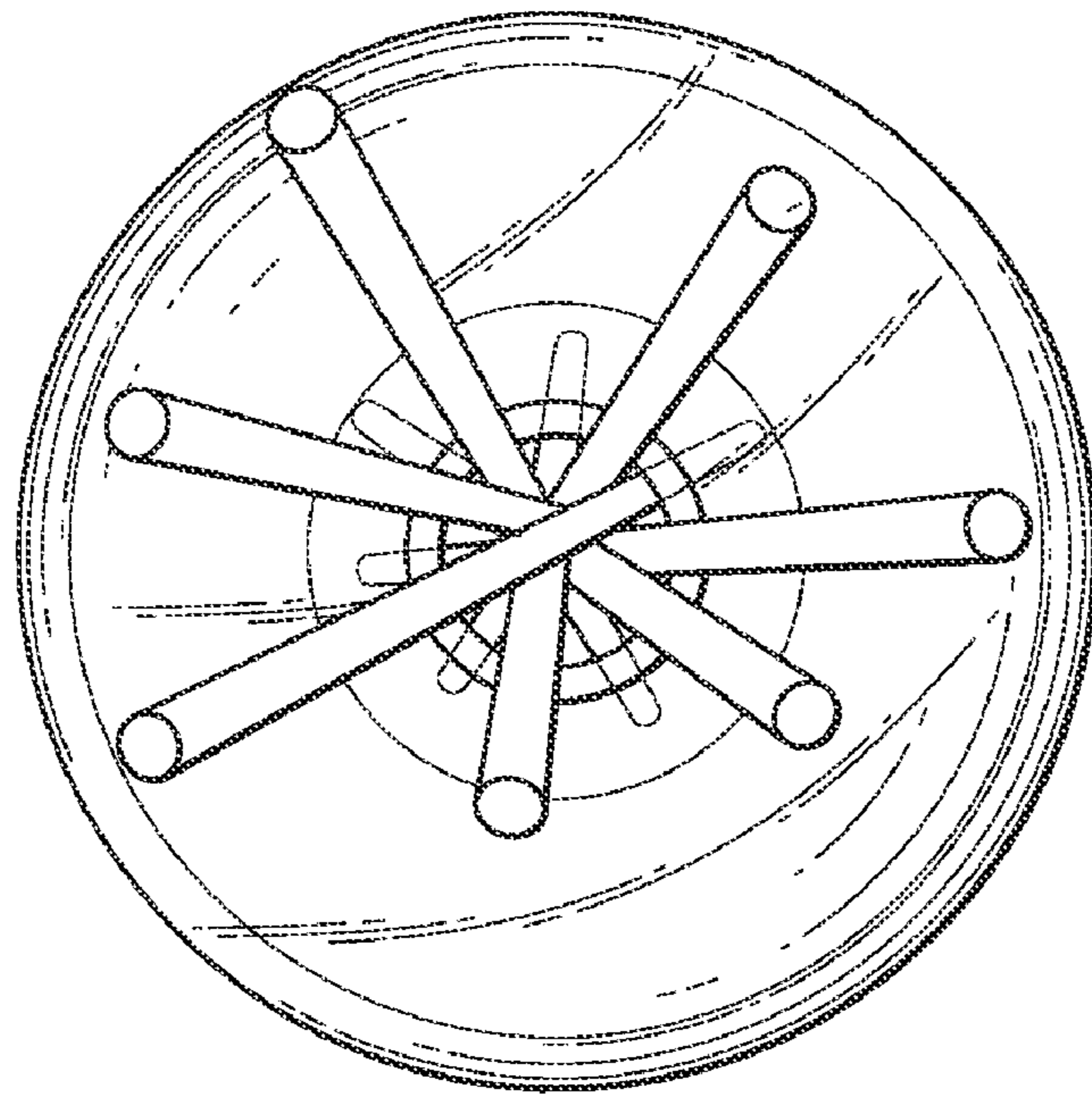

FIG. 2

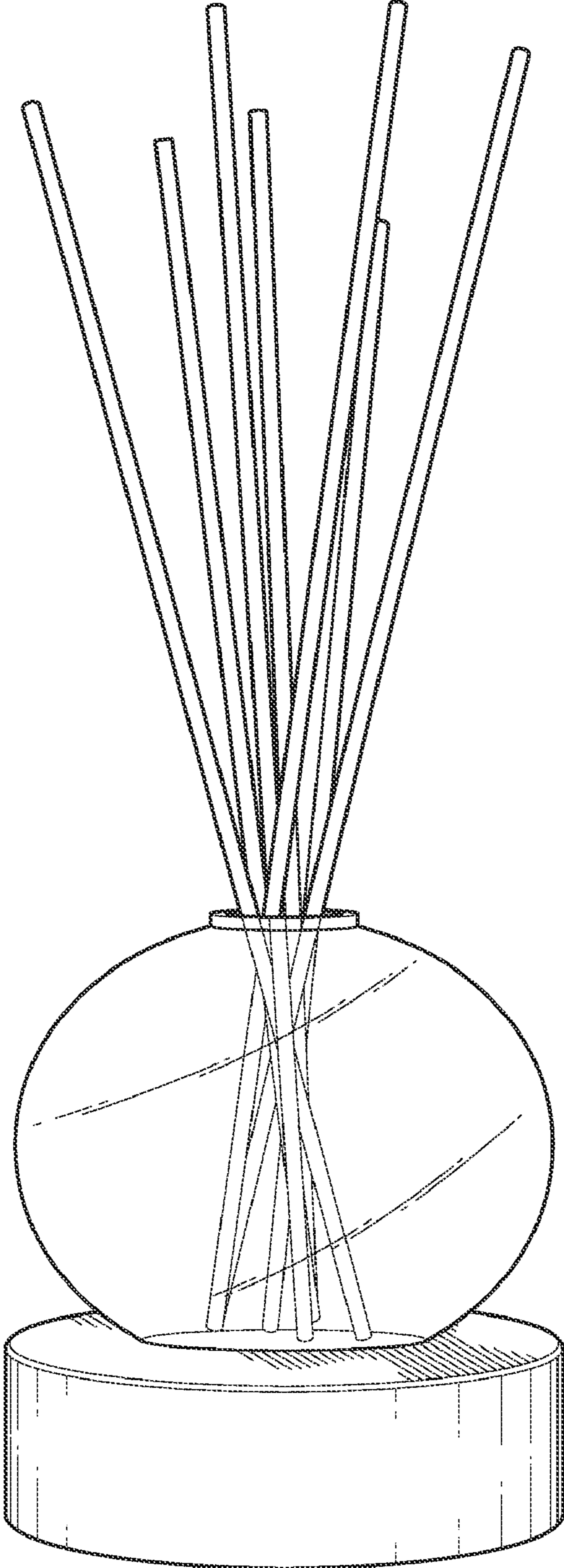

FIG. 3

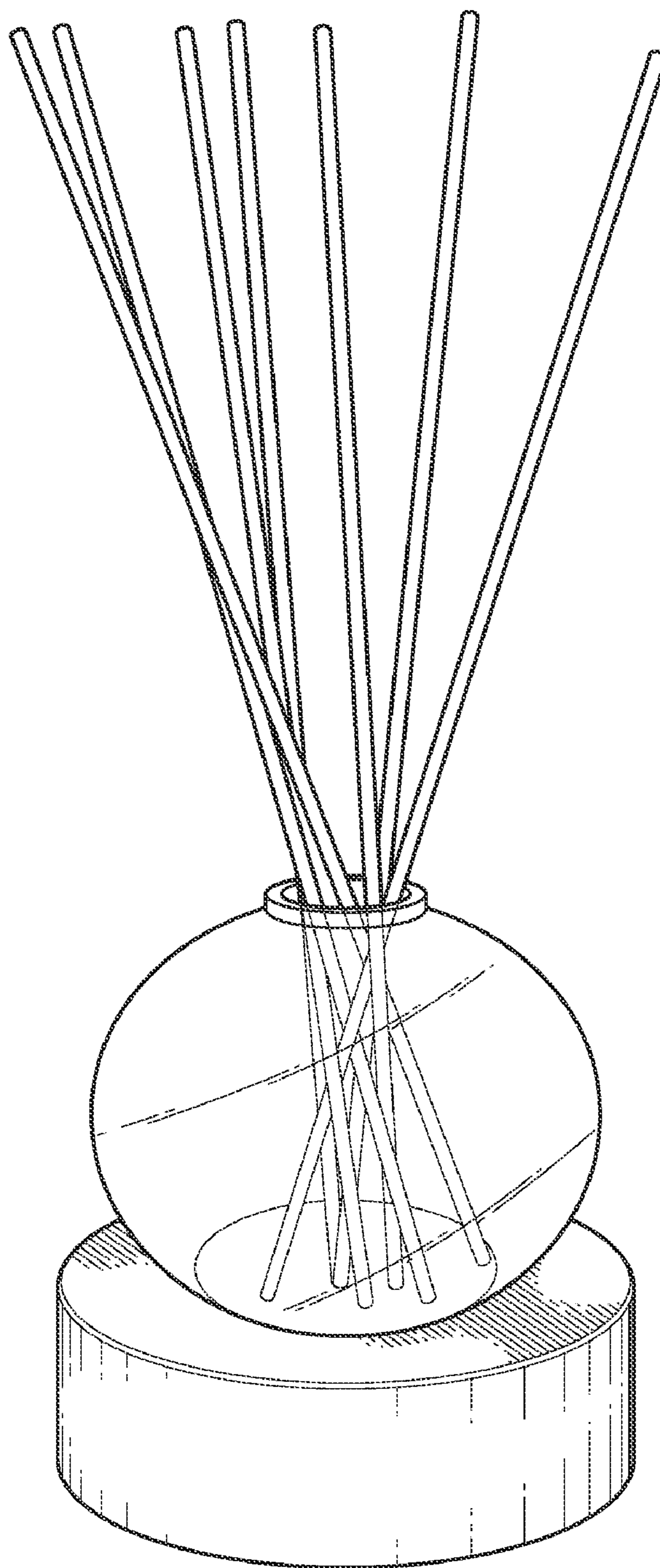

FIG. 4

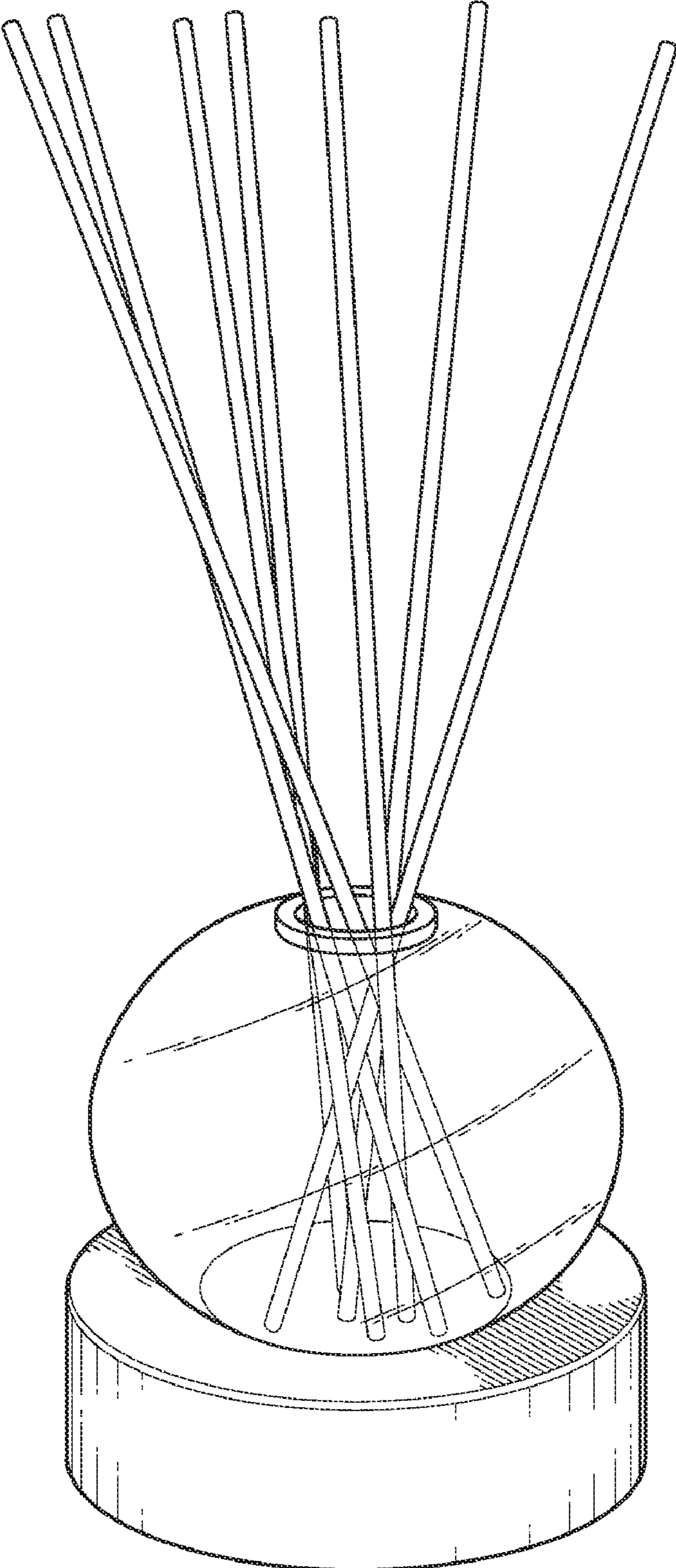

FIG. 5

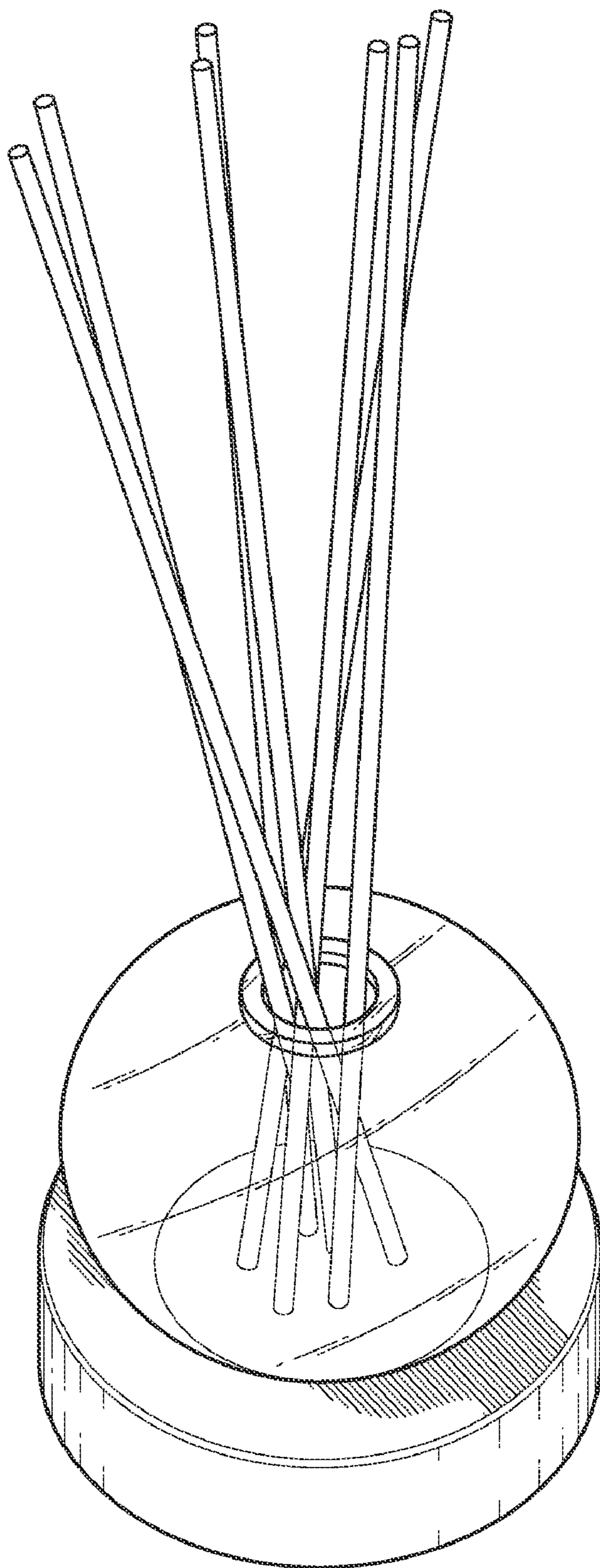

FIG. 6

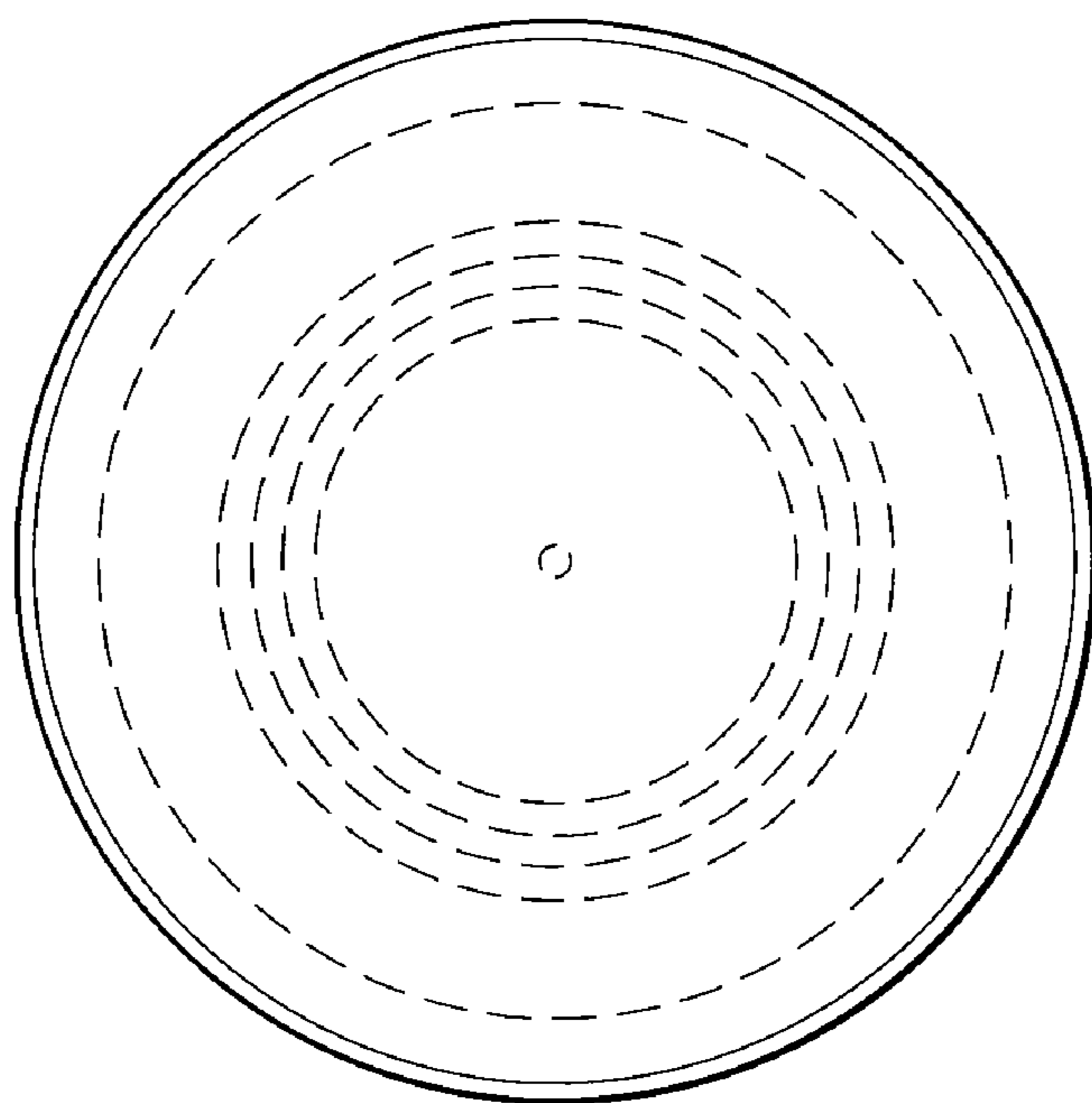

FIG. 7