



US00D652115S

(12) **United States Design Patent**
Wang et al.

(10) **Patent No.:** **US D652,115 S**
(45) **Date of Patent:** **** Jan. 10, 2012**

(54) **SHOWER HEAD**

(75) Inventors: **Tien-I Wang**, Taichung (TW); **Yang Dong**, Taichung (TW)

(73) Assignee: **Globe Union Industrial Corp.**,
Taichung (TW)

(**) Term: **14 Years**

(21) Appl. No.: **29/392,855**

(22) Filed: **May 27, 2011**

(51) **LOC (9) Cl.** **23-01**

(52) **U.S. Cl.** **D23/229**

(58) **Field of Classification Search** D23/213,
D23/229, 230; 239/282, 283, 462
See application file for complete search history.

(56) **References Cited**

U.S. PATENT DOCUMENTS

D188,644 S *	8/1960	Kohler	D23/229
D188,645 S *	8/1960	Kohler	D23/213
D189,117 S *	10/1960	Kohler	D23/229
D215,936 S *	11/1969	Contreras	D23/229

D231,829 S *	6/1974	Frasier	D23/230
D245,618 S *	8/1977	Pitman	D23/229
D548,817 S *	8/2007	Dingler et al.	D23/229
D560,756 S *	1/2008	Tse	D23/229
D617,414 S *	6/2010	Sofield	D23/213

* cited by examiner

Primary Examiner — Robin V Webster

(74) *Attorney, Agent, or Firm* — Leong C. Lei

(57) **CLAIM**

The ornamental design for a shower head, as shown and described.

DESCRIPTION

FIG. 1 is a top plan view of a shower head showing our new design;
FIG. 2 is a bottom plan view thereof;
FIG. 3 is a left side elevational view thereof;
FIG. 4 is a right side elevational view thereof;
FIG. 5 is a rear elevational view thereof;
FIG. 6 is a front elevational view thereof;
FIG. 7 is a front perspective view thereof; and,
FIG. 8 is a rear perspective view thereof.

1 Claim, 8 Drawing Sheets

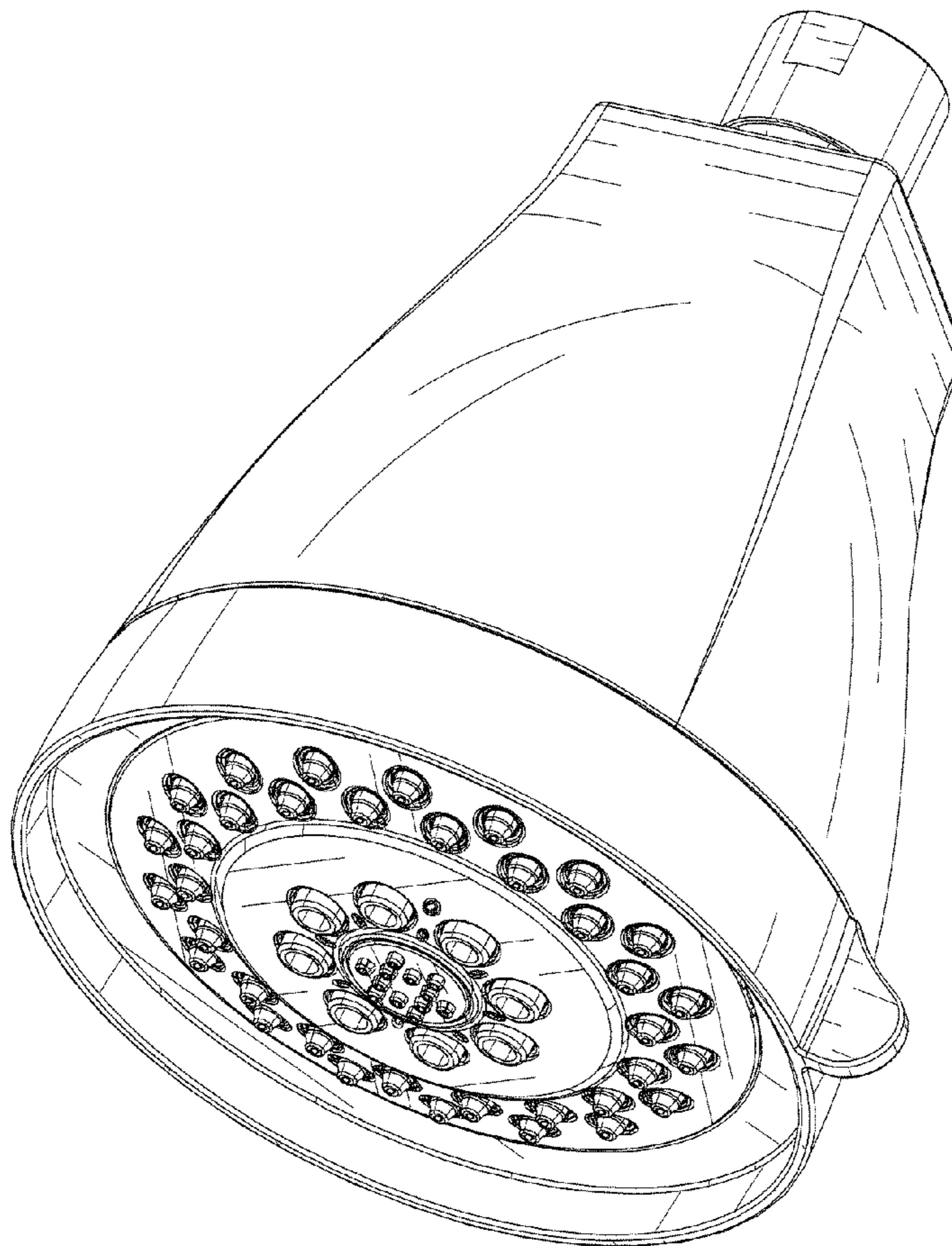

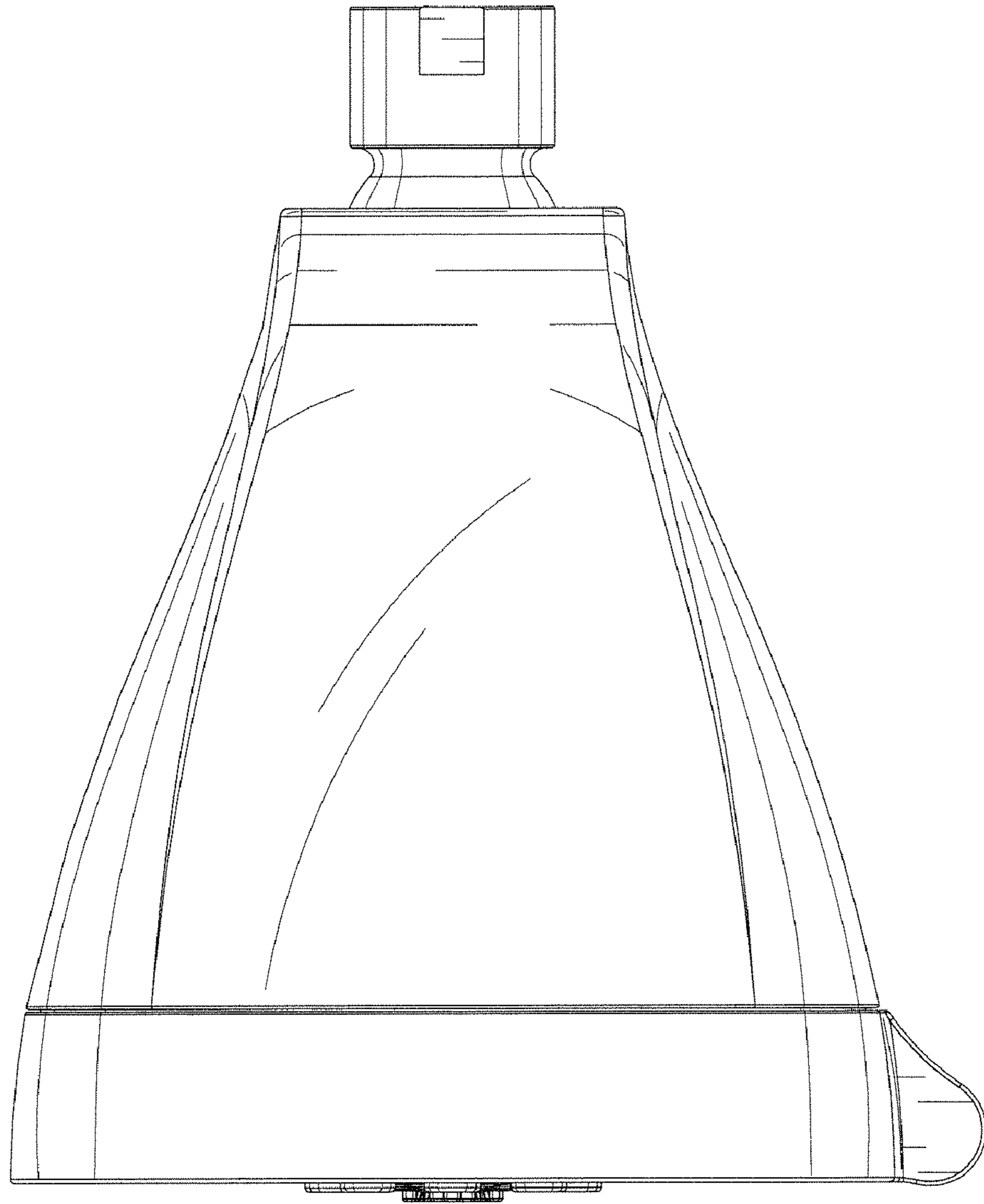

FIG. 1

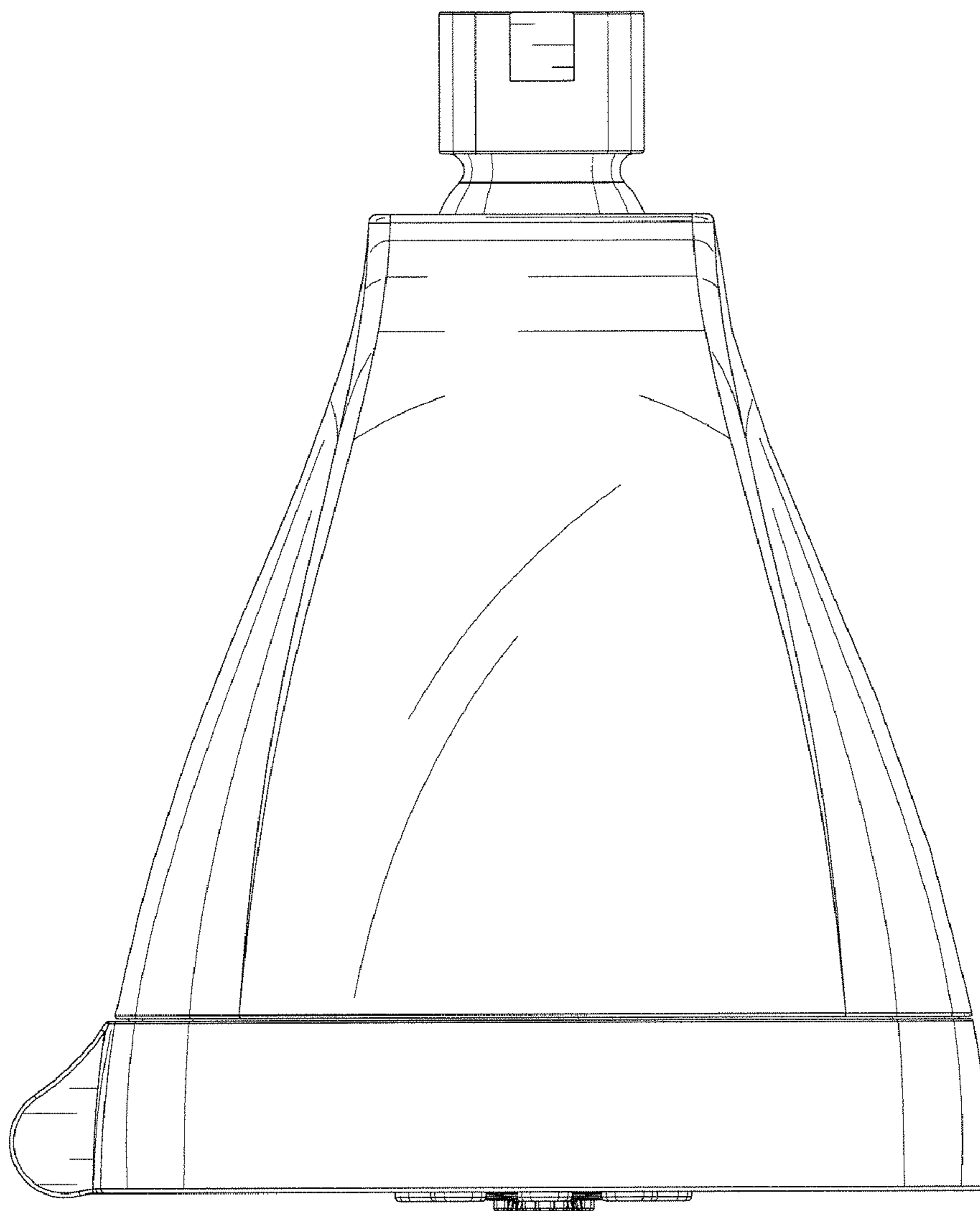

FIG. 2

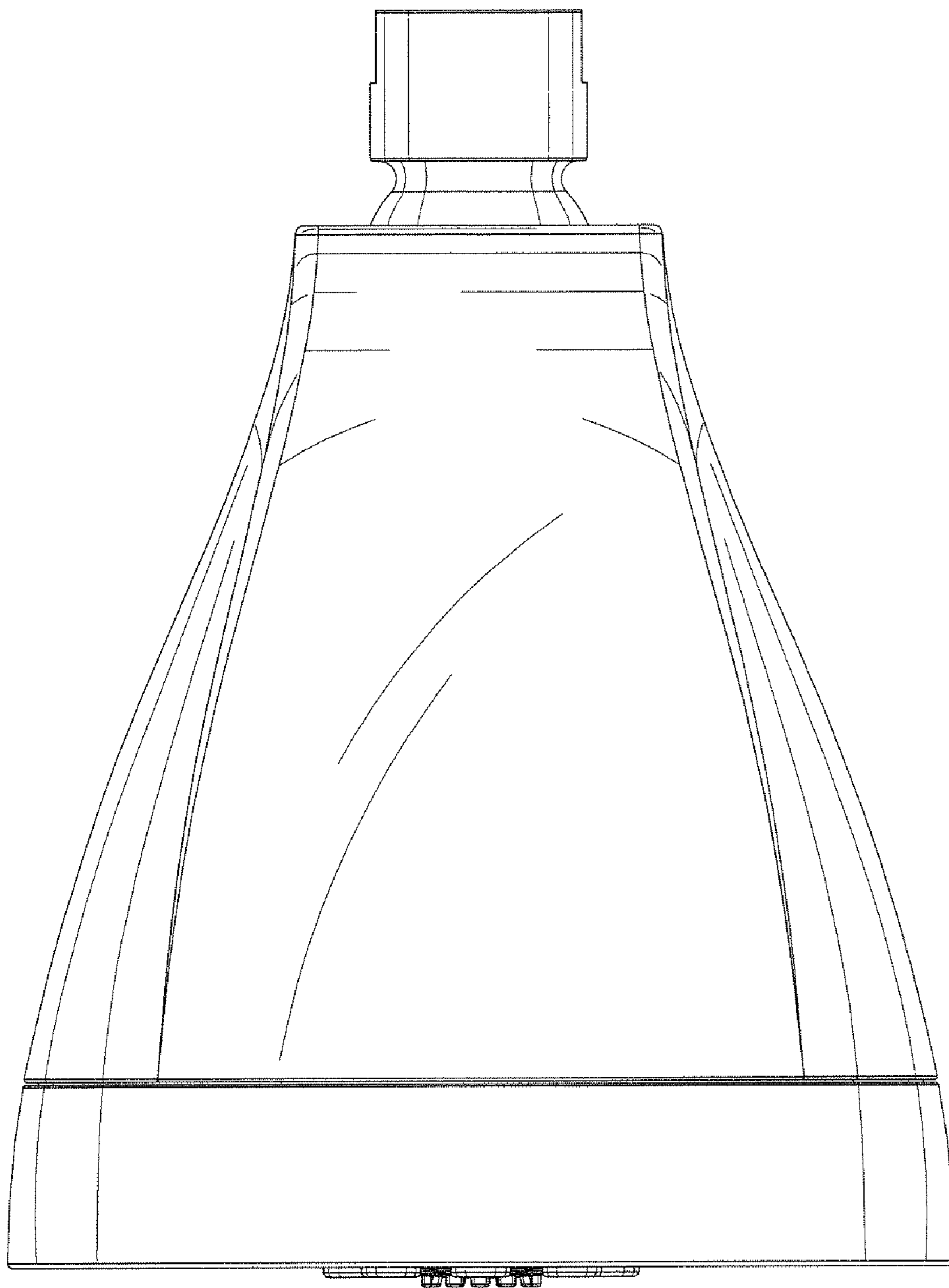

FIG. 3

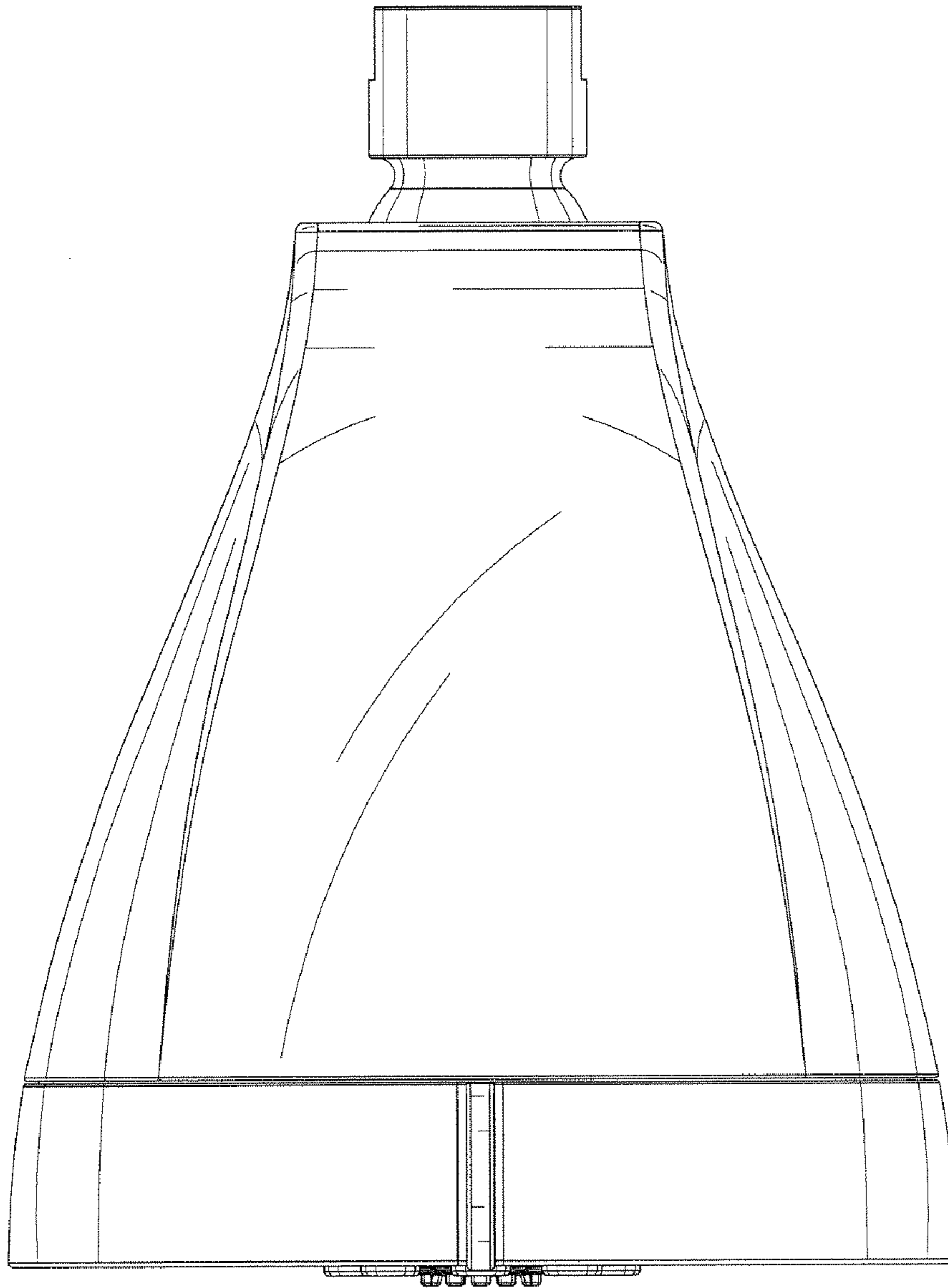

FIG. 4

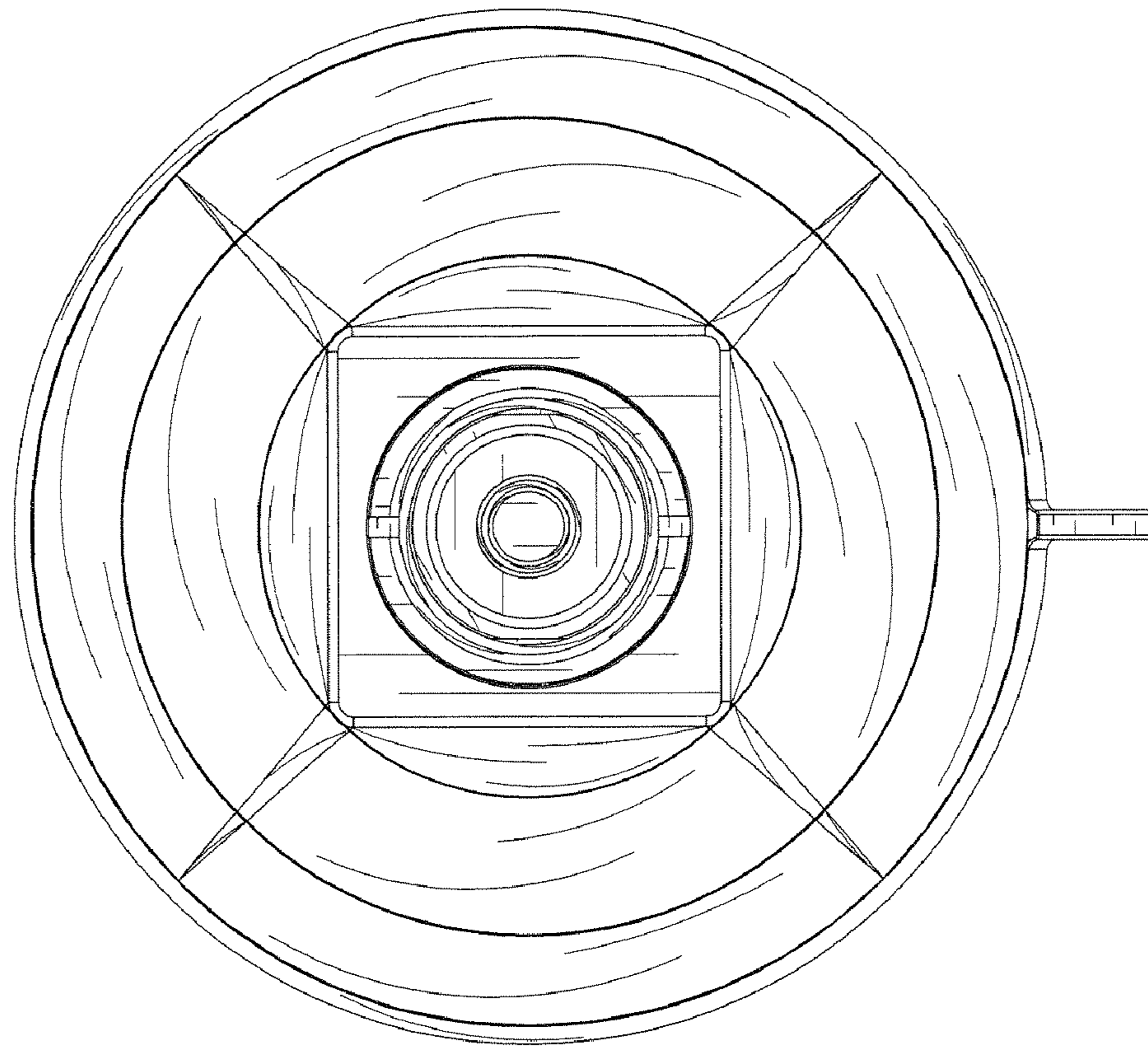

FIG. 5

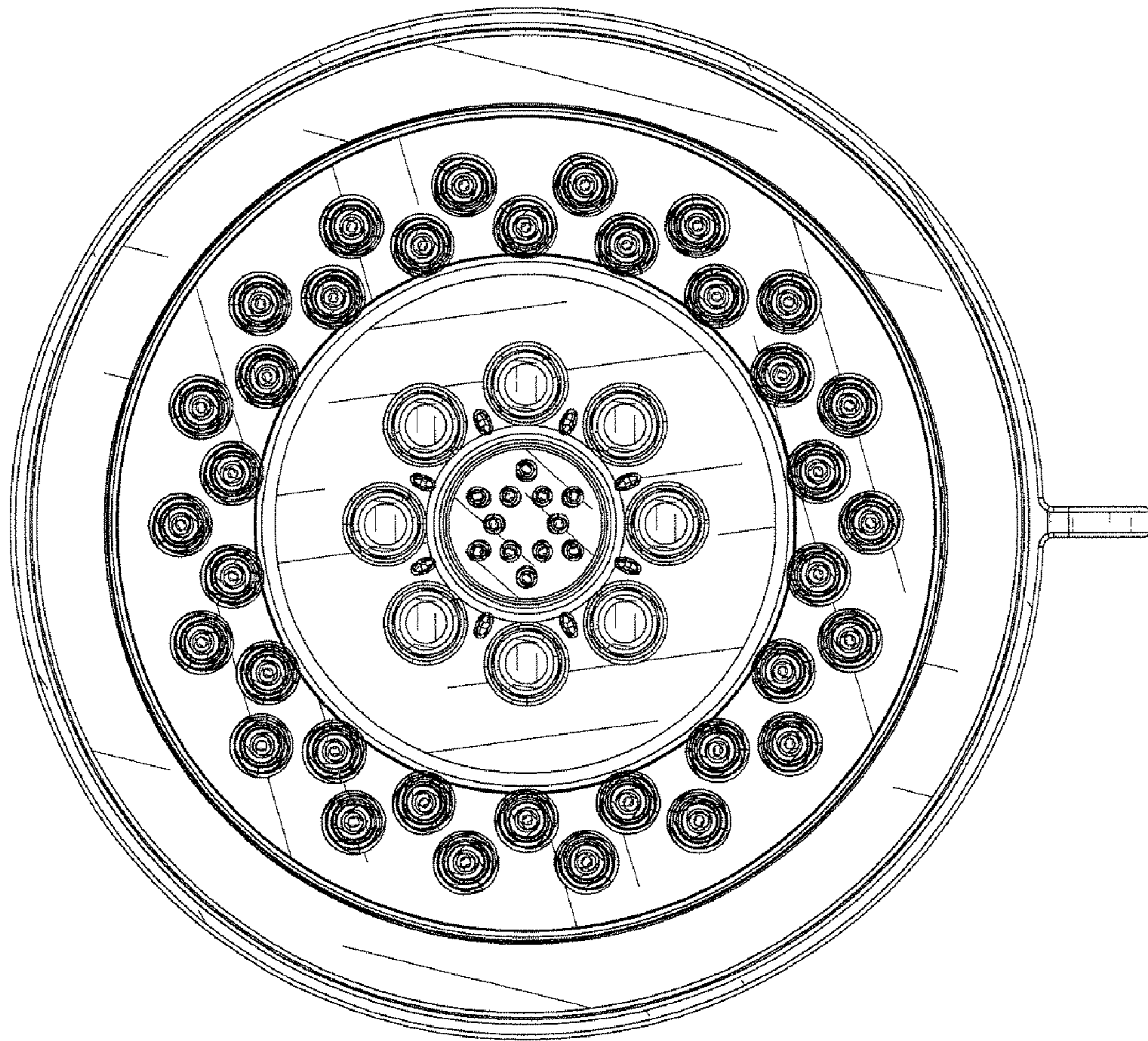

FIG. 6

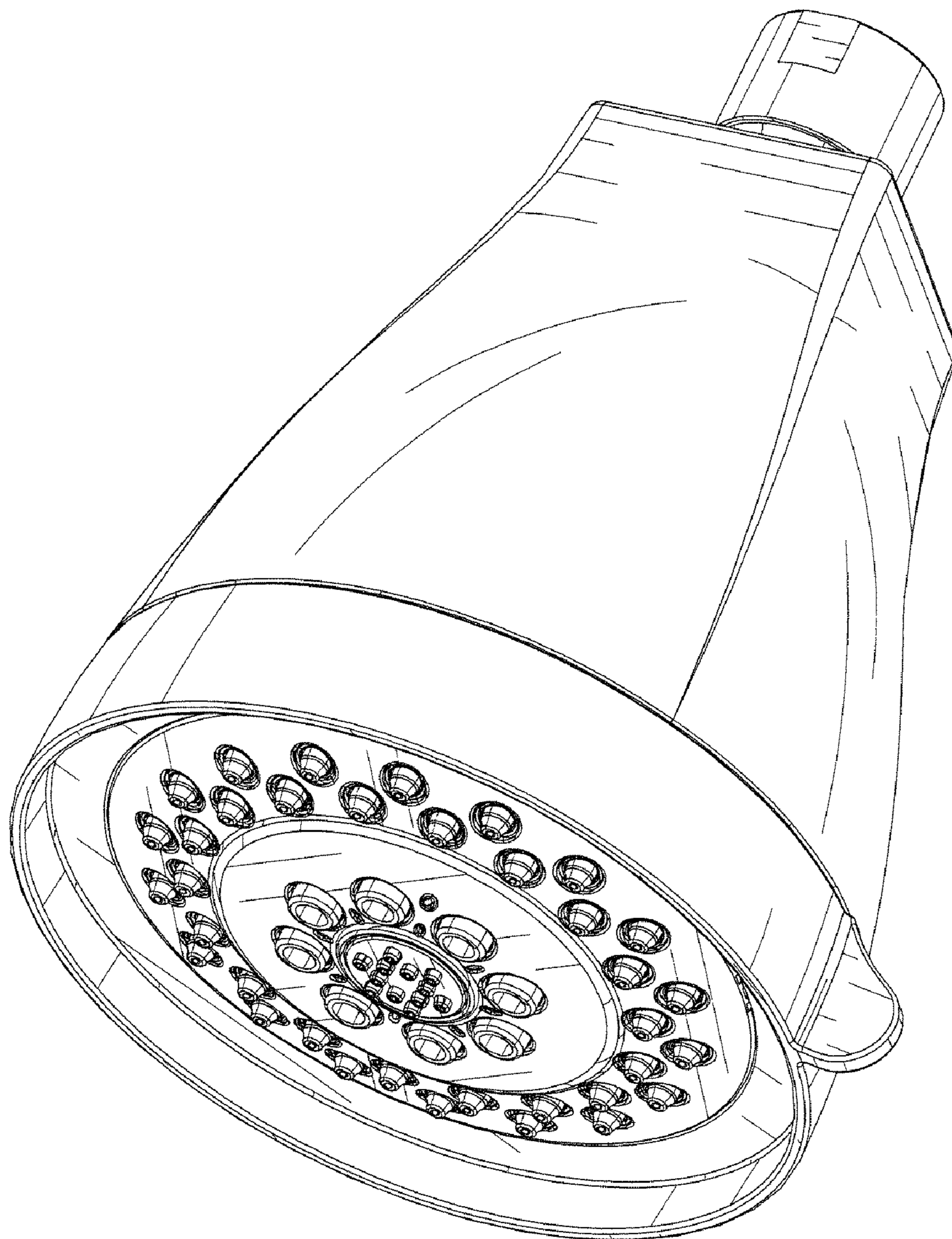

FIG. 7

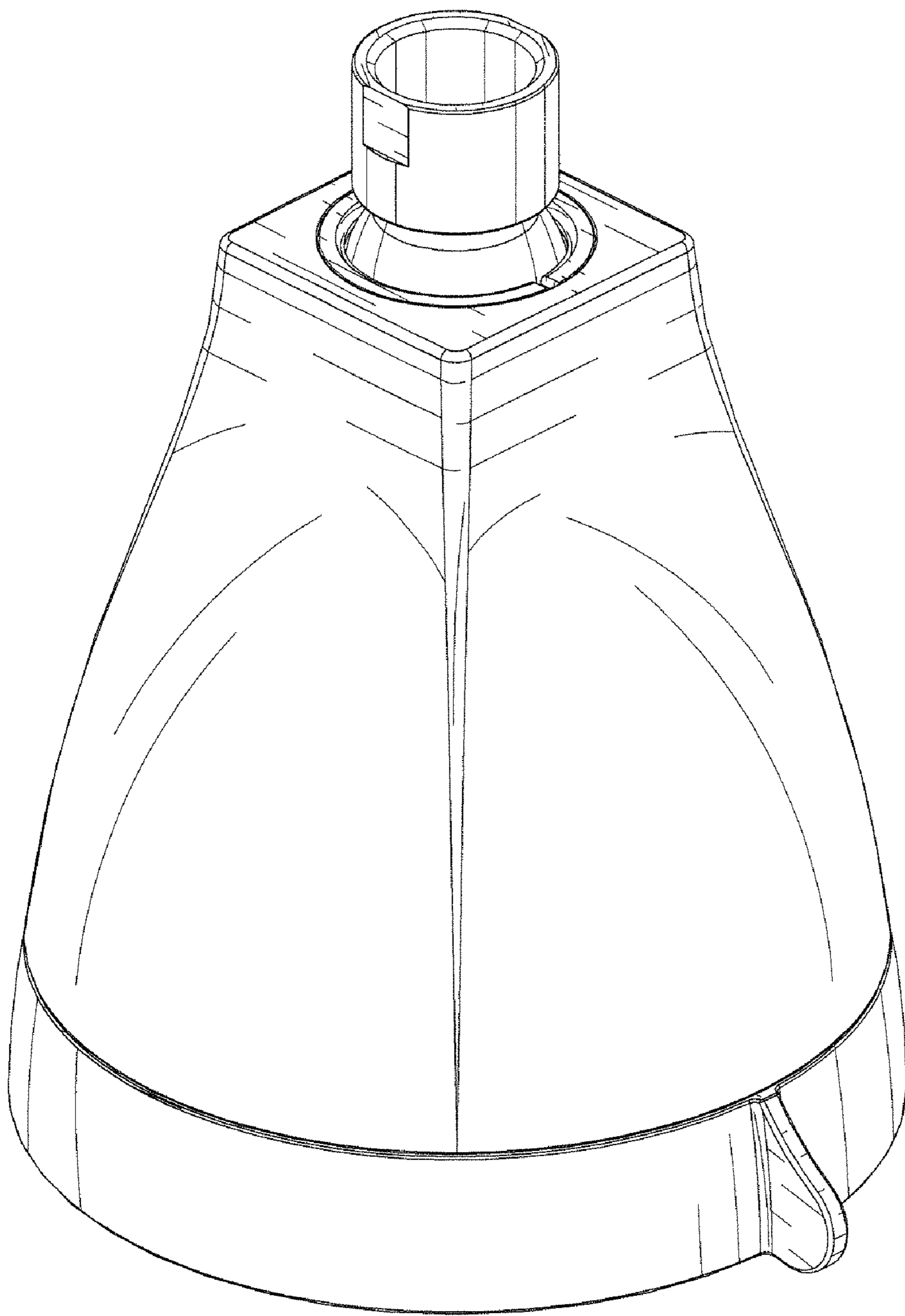

FIG. 8