



US00D652106S

(12) **United States Design Patent**
Yoo

(10) **Patent No.:** **US D652,106 S**

(45) **Date of Patent:** **** Jan. 10, 2012**

(54) **FACEPLATE FOR SHOWERHEAD**

(75) **Inventor:** **Man Ki Yoo**, Skokie, IL (US)

(73) **Assignee:** **Alsons Corporation**, Hillsdale, MI (US)

(**) **Term:** **14 Years**

(21) **Appl. No.:** **29/389,850**

(22) **Filed:** **Apr. 18, 2011**

(51) **LOC (9) Cl.** **23-01**

(52) **U.S. Cl.** **D23/213**

(58) **Field of Classification Search** D23/213,
D23/223, 226, 229, 230; 239/282, 283, 527
See application file for complete search history.

(56) **References Cited**

U.S. PATENT DOCUMENTS

D557,764 S * 12/2007 Schonherr et al. D23/213
D576,251 S * 9/2008 Schonherr et al. D23/213

D599,881 S * 9/2009 Wang et al. D23/213
D618,303 S * 6/2010 Zhang D23/213
D619,202 S * 7/2010 Zhang D23/213

* cited by examiner

Primary Examiner — Robin V Webster

(74) *Attorney, Agent, or Firm* — Edgar A. Zarins; Nirav D. Parikh; Lora J. Graentzdoerffer

(57) **CLAIM**

The ornamental design for a faceplate for showerhead, as shown and described.

DESCRIPTION

FIG. 1 is a perspective view of a faceplate for showerhead showing my new design;
FIG. 2 is a front elevational view thereof;
FIG. 3 is a first side view thereof;
FIG. 4 is a second side view thereof;
FIG. 5 is a third side view thereof; and,
FIG. 6 is a fourth side view thereof.

1 Claim, 2 Drawing Sheets

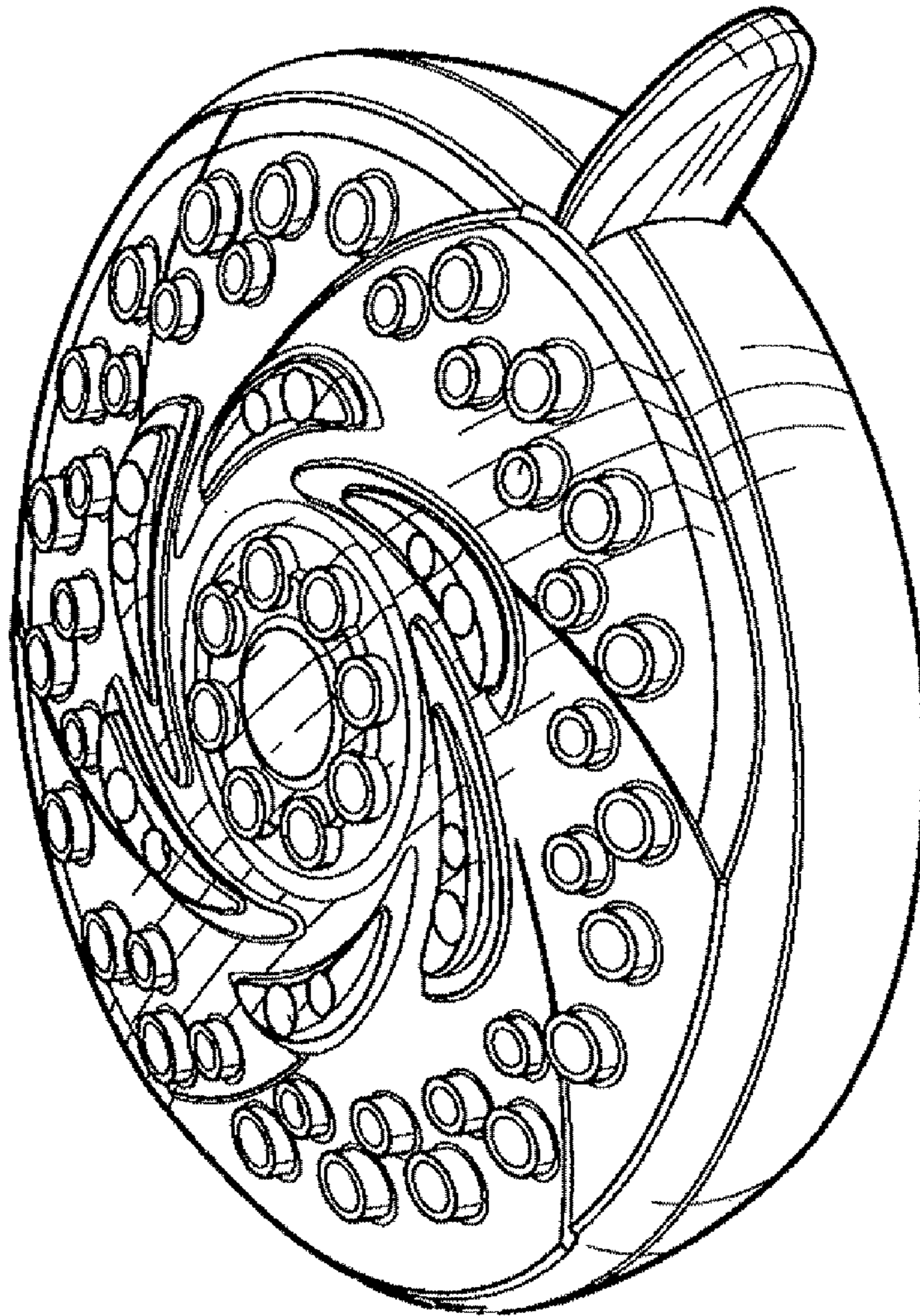

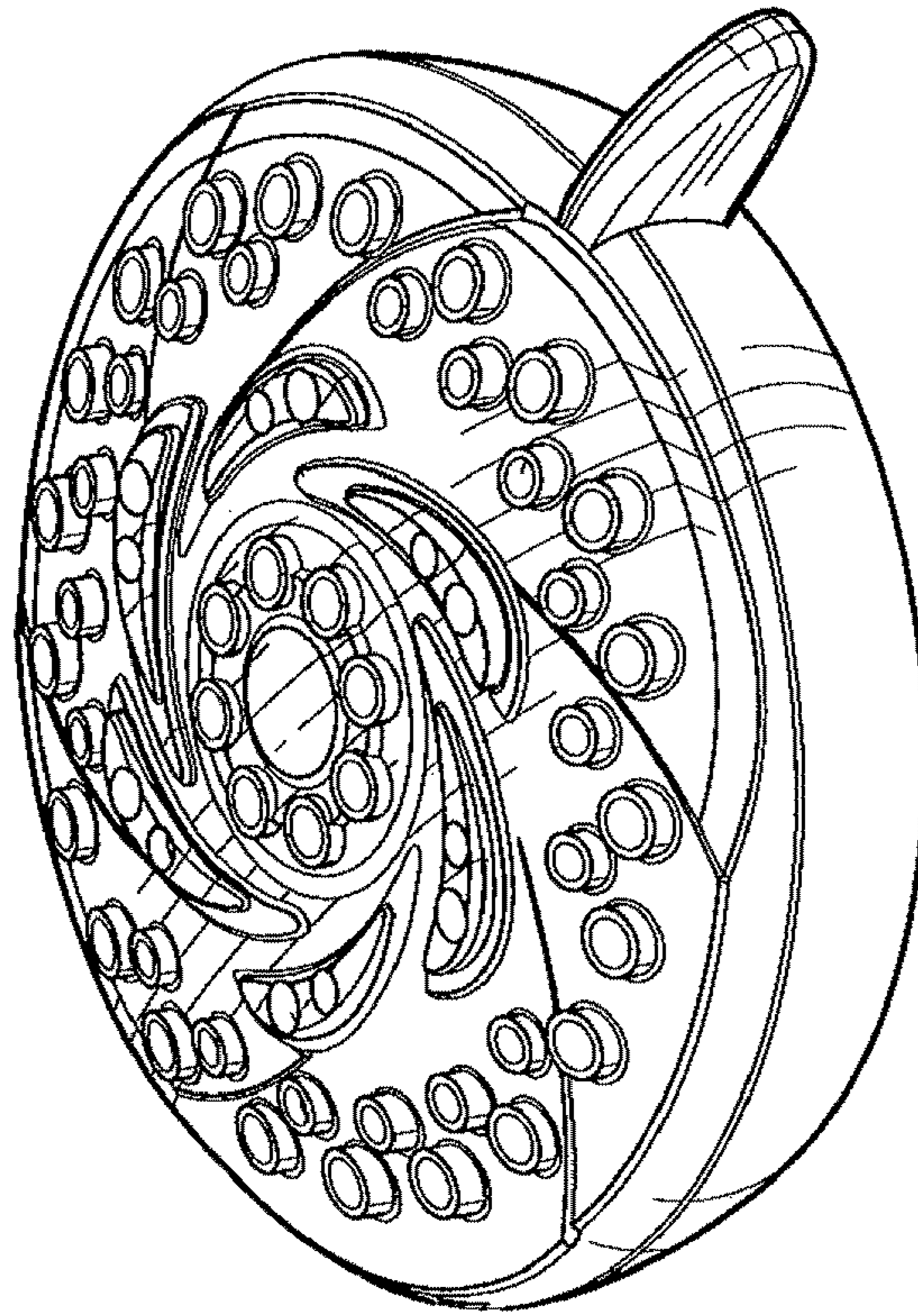

Fig-1

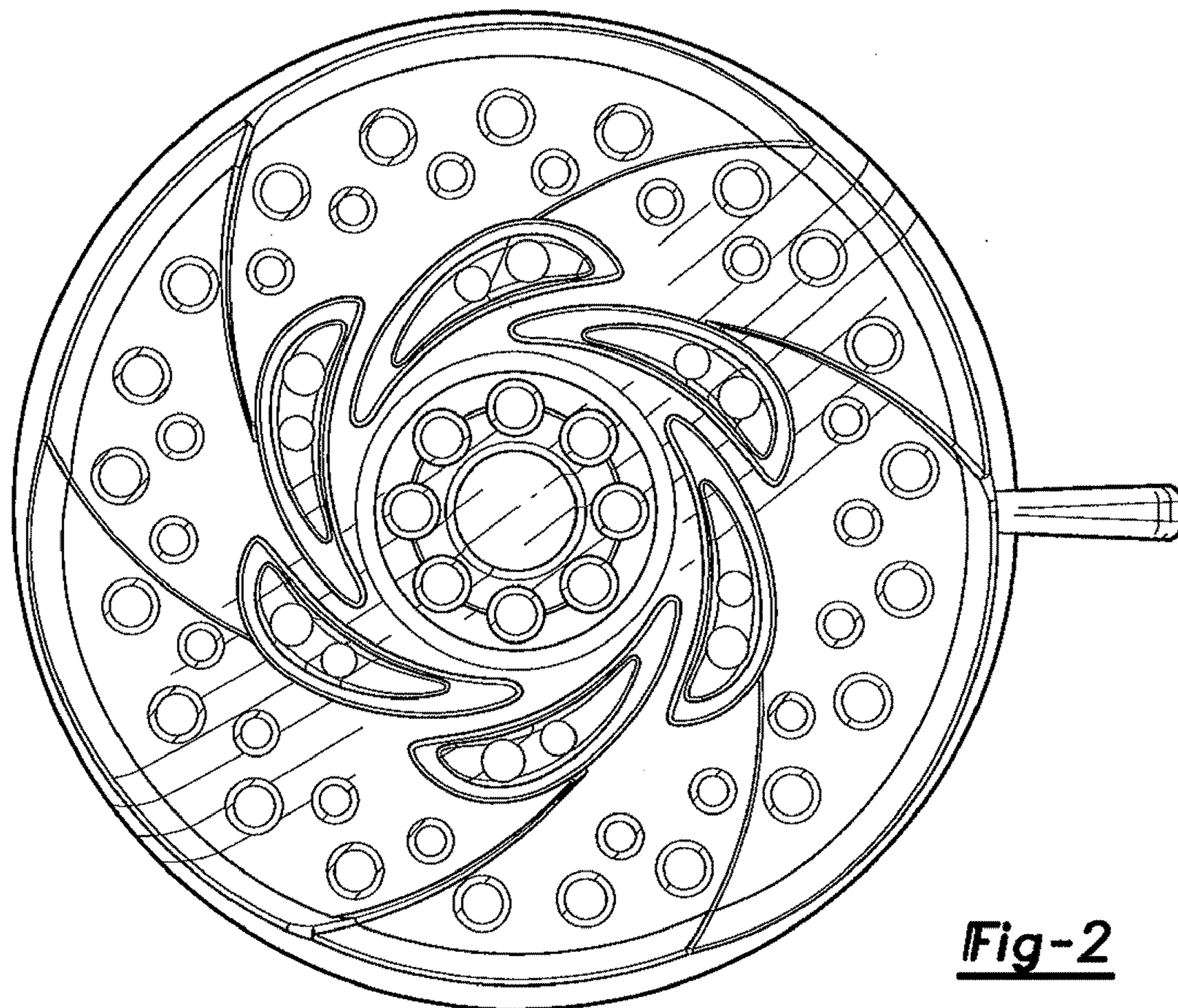

Fig-2

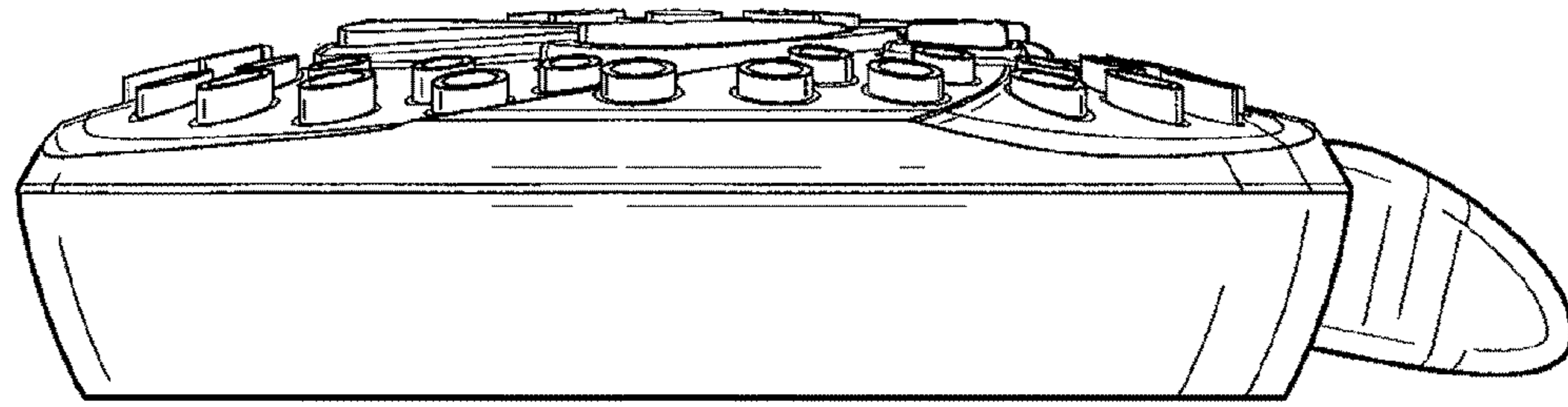

Fig-3

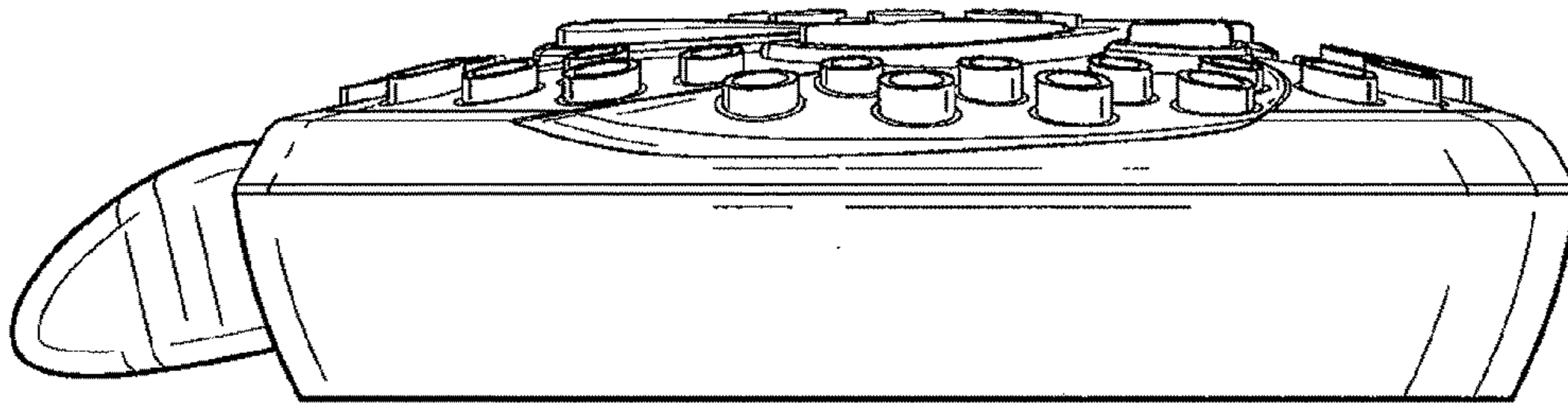

Fig-4

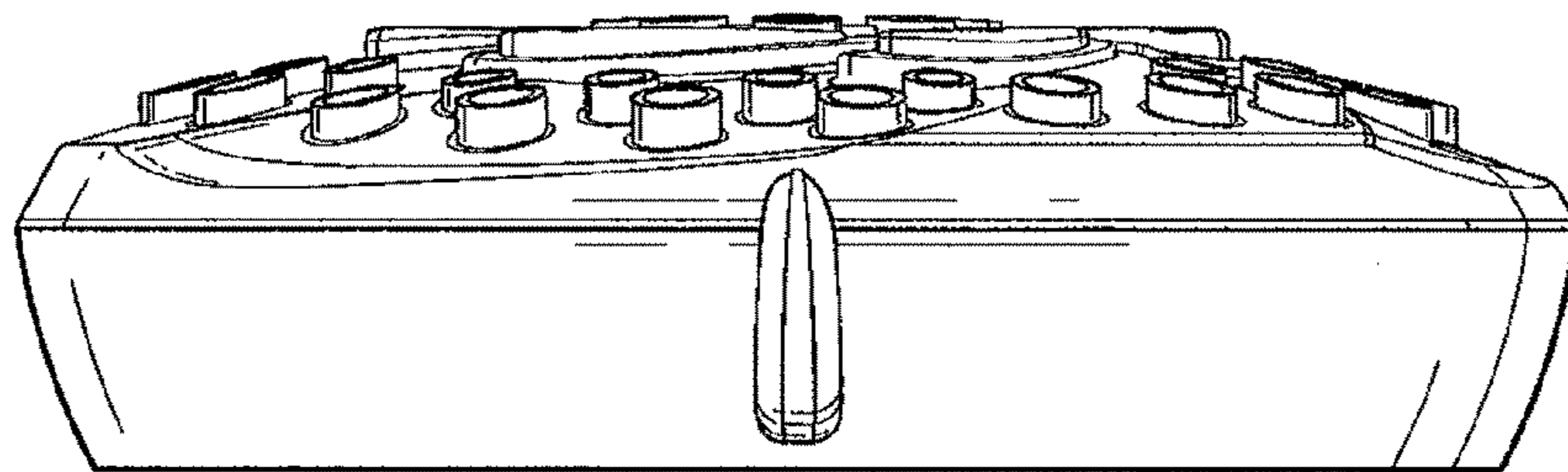

Fig-5

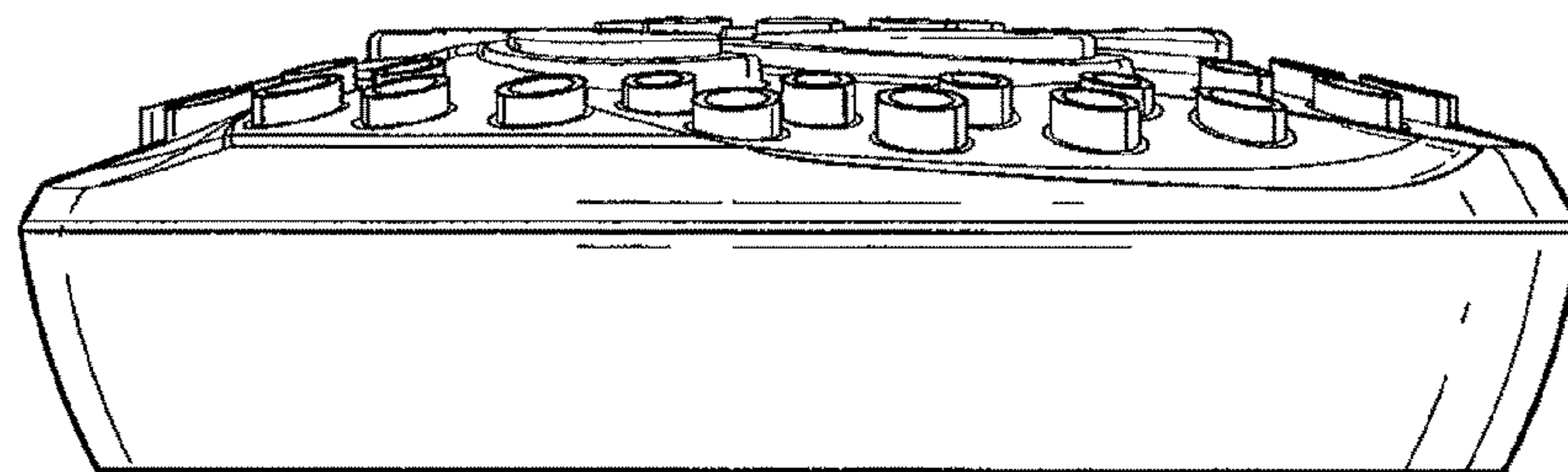

Fig-6