



US00D652058S

(12) **United States Design Patent**
Gherlenda

(10) **Patent No.:** **US D652,058 S**
(45) **Date of Patent:** **** Jan. 10, 2012**

(54) **MOTOR**

(75) Inventor: **Roberto Gherlenda**, Oderzo (IT)

(73) Assignee: **NICE S.p.A.**, Oderzo (IT)

(**) Term: **14 Years**

(21) Appl. No.: **29/397,889**

(22) Filed: **Jul. 22, 2011**

Related U.S. Application Data

(62) Division of application No. 29/384,793, filed on Feb. 3, 2011.

(51) **LOC (9) Cl.** **15-01**

(52) **U.S. Cl.** **D15/1**

(58) **Field of Classification Search** D15/1,
D15/2, 3, 5, 6, 14, 17, 149; 123/22, 41.34,
123/51 A, 606 R, 52.1, 50 A, 50 B, 54.1,
123/54.2, 54.4, 54.5, 65 R, 195 R, 195 HC,
123/657, 311

See application file for complete search history.

(56) **References Cited**

U.S. PATENT DOCUMENTS

D602,562 S	10/2009	Harada	
D602,563 S	10/2009	Ito et al.	
D610,232 S	2/2010	Harada	
D630,650 S *	1/2011	Hsu	D15/1
D633,924 S	3/2011	Brancato	
D634,335 S	3/2011	Harada et al.	

* cited by examiner

Primary Examiner — T. Chase Nelson

Assistant Examiner — Ania Aman

(74) *Attorney, Agent, or Firm* — Birch, Stewart, Kolasch & Birch, LLP

(57) **CLAIM**

The ornamental design for a motor, as shown and described.

DESCRIPTION

FIG. 1 is a front view of a motor showing my new design;
FIG. 2 is a rear view thereof;
FIG. 3 is a left-side view thereof;
FIG. 4 is a right-side view thereof;
FIG. 5 is a top view thereof; and
FIG. 6 is a front, right perspective view thereof.
The bottom view is unornamented.

1 Claim, 6 Drawing Sheets

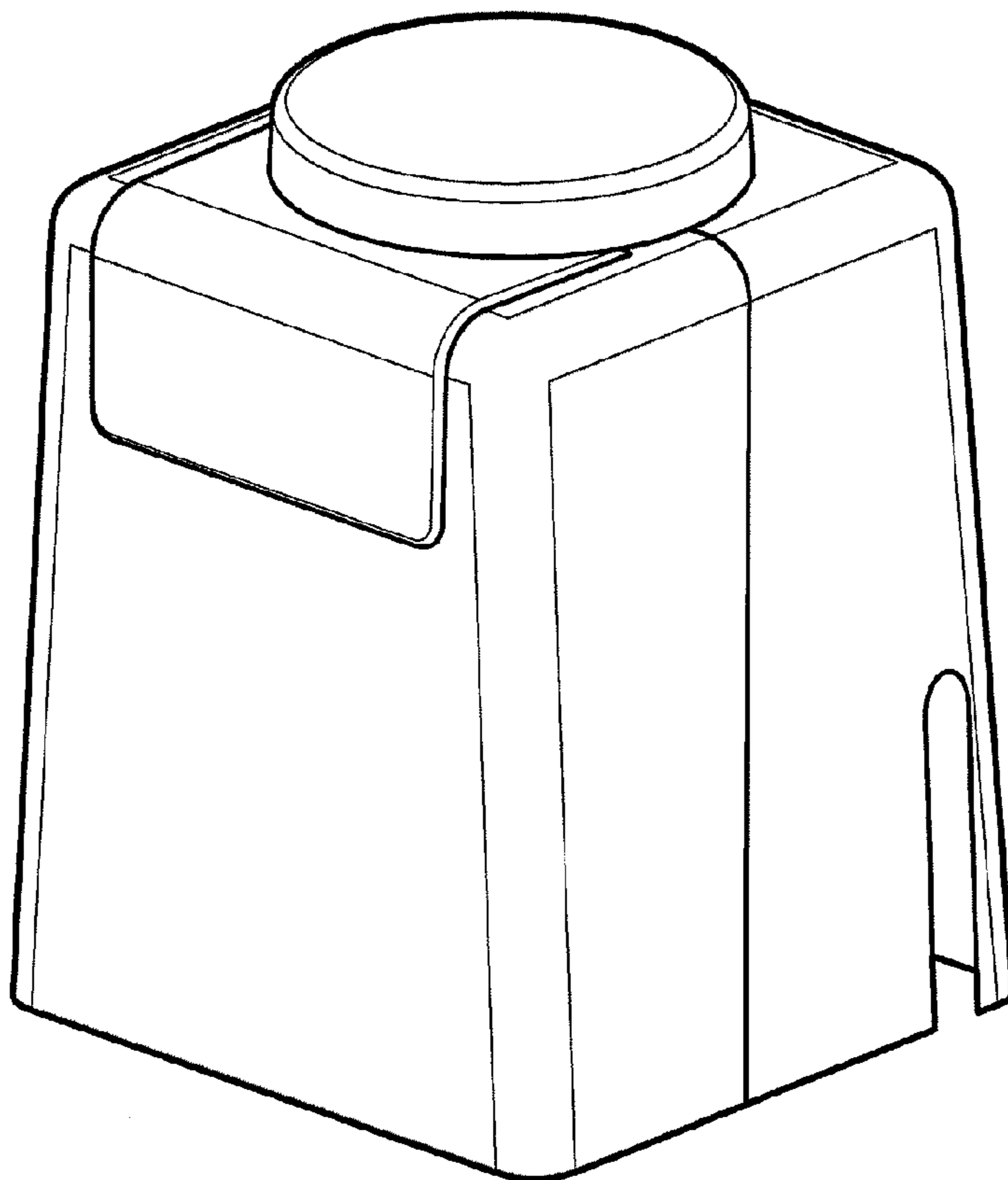

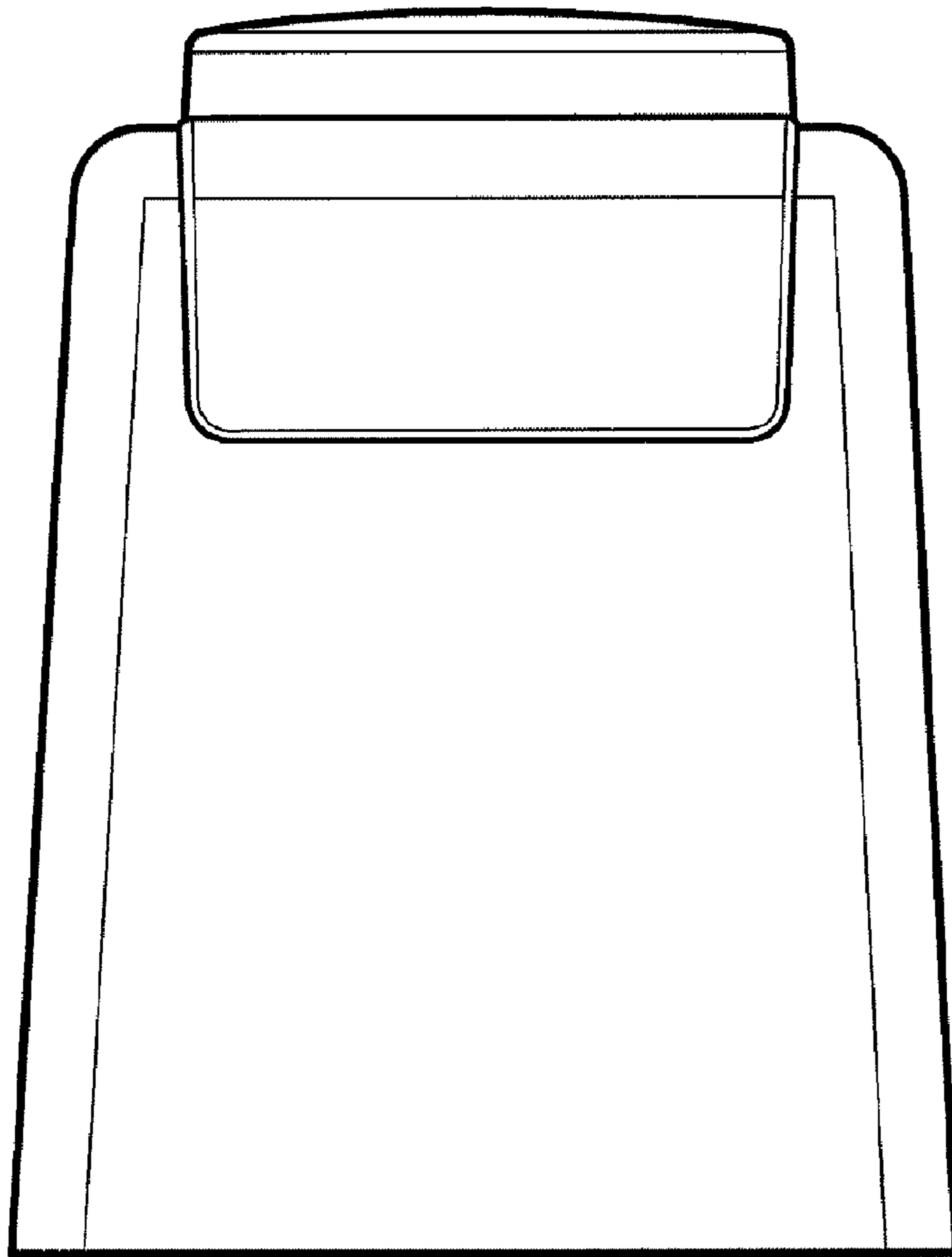

FIG. 1

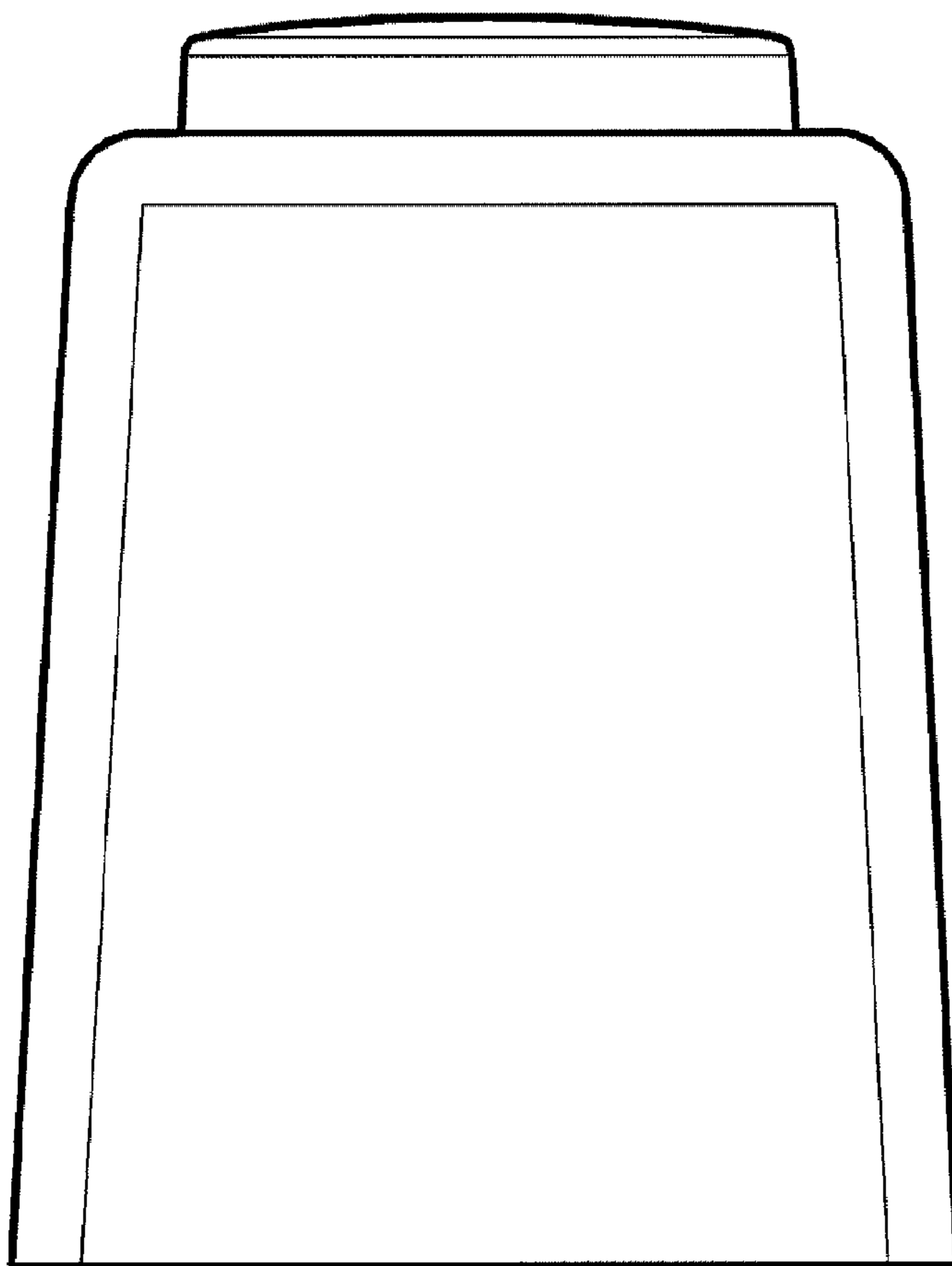

FIG. 2

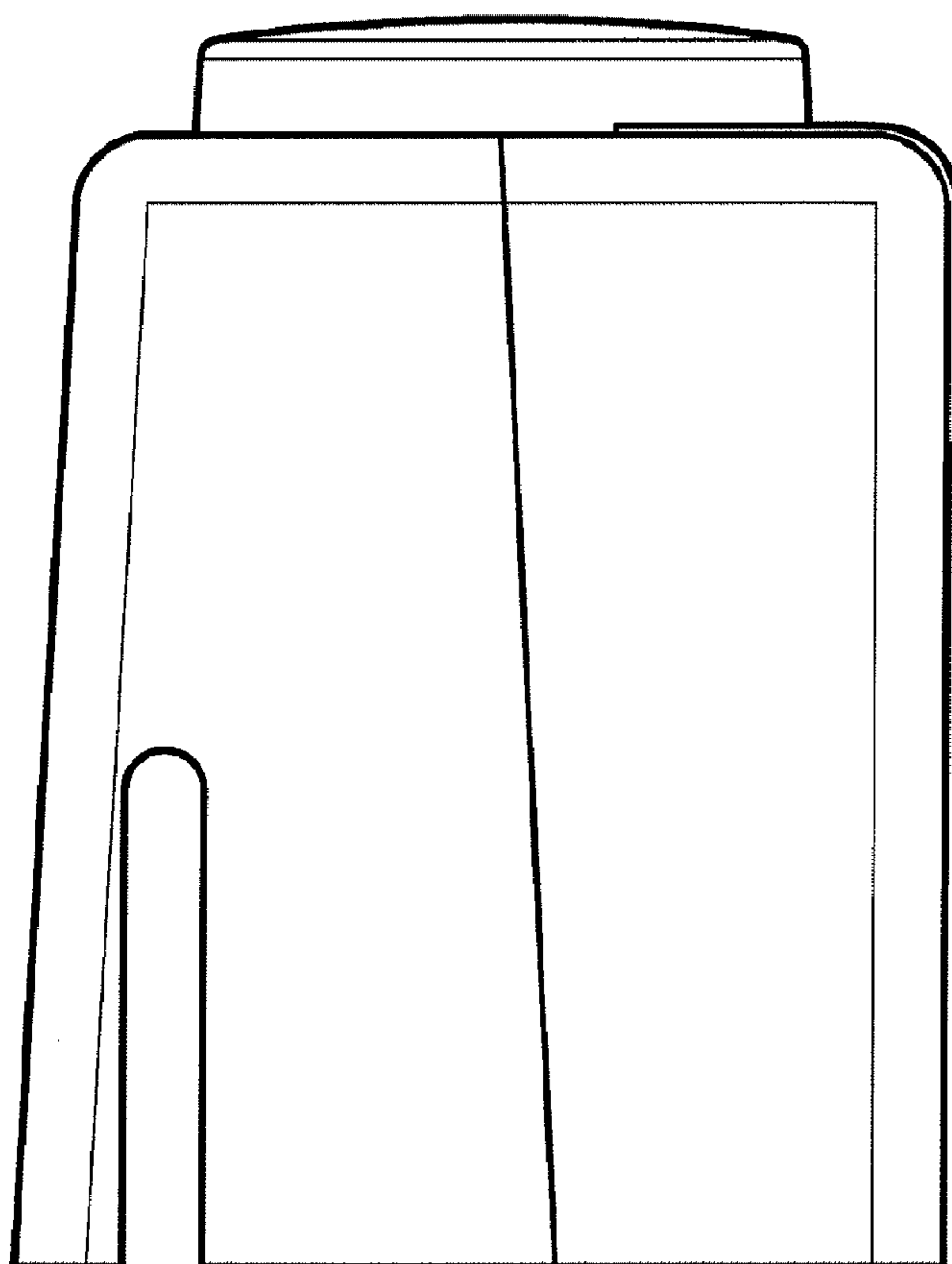

FIG. 3

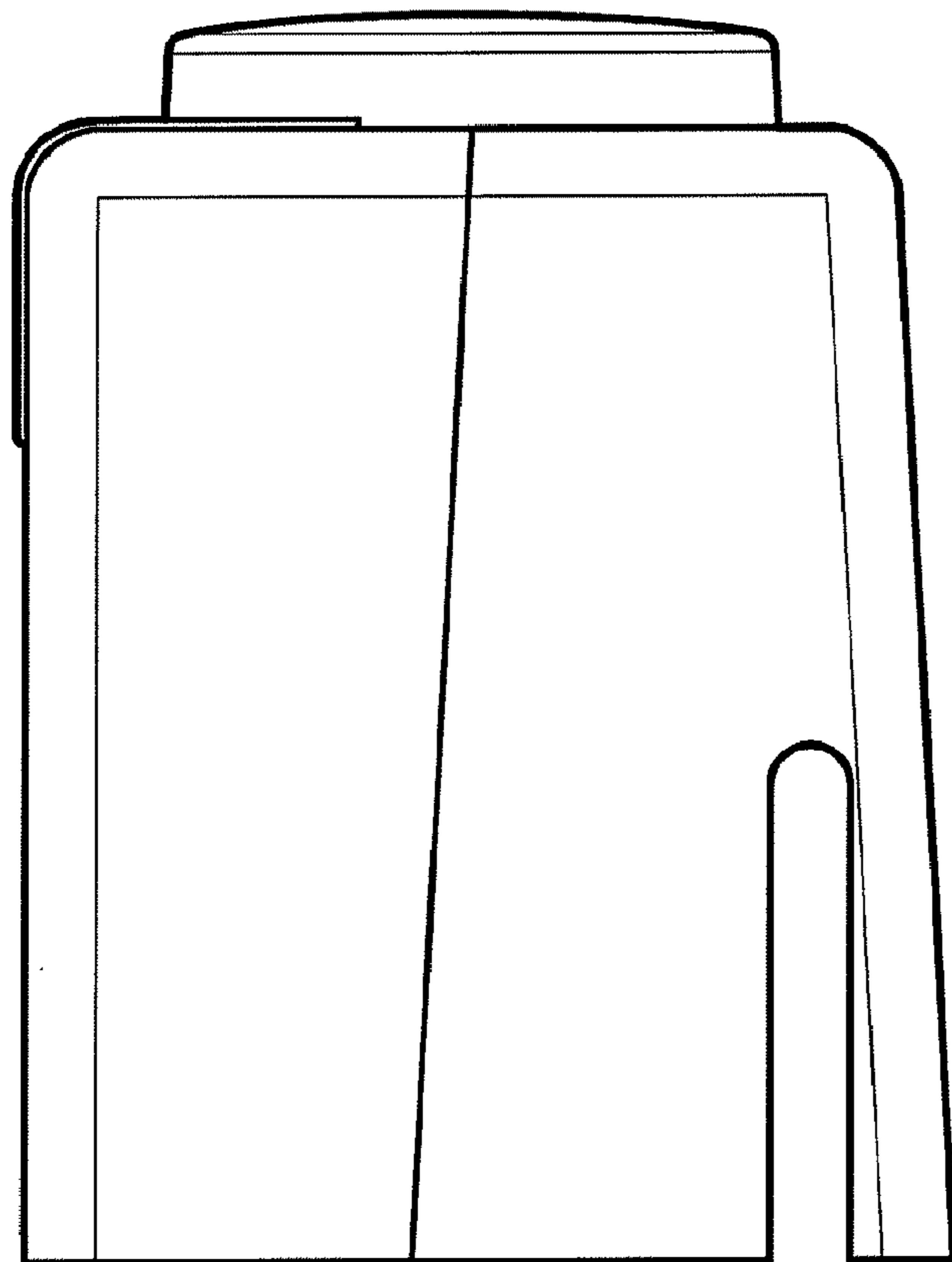

FIG. 4

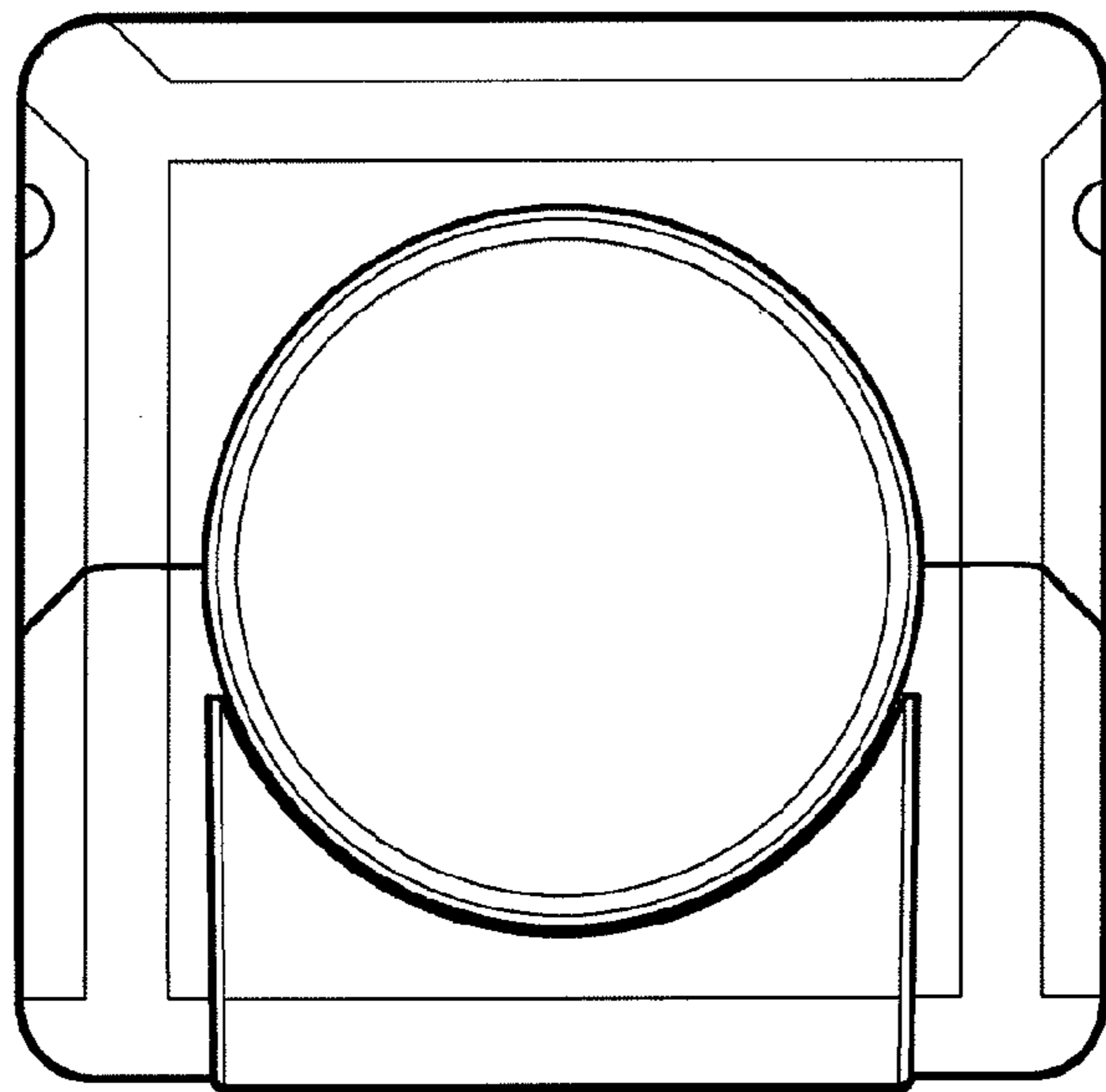

FIG. 5

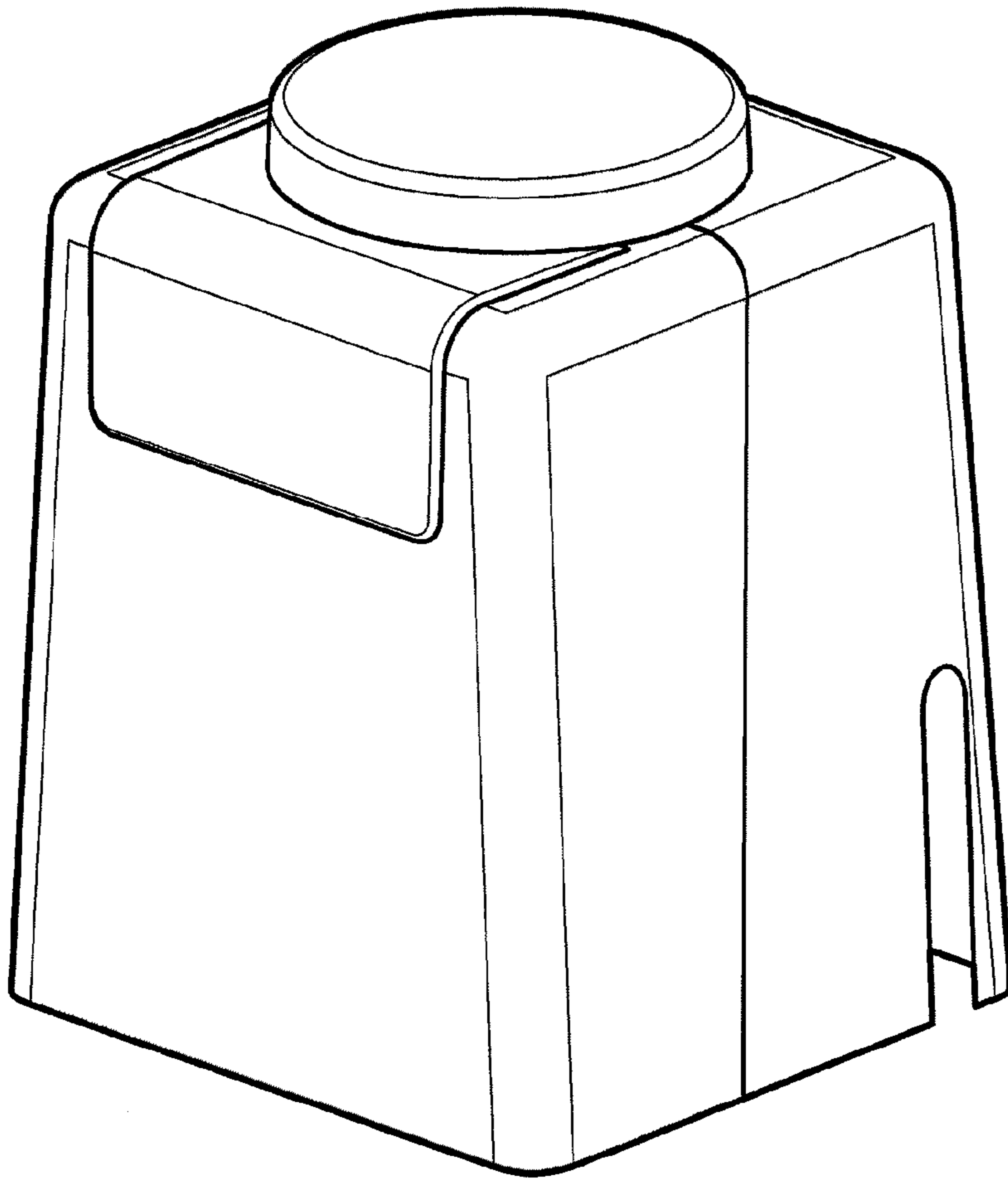

FIG. 6