



US00D652016S

(12) **United States Design Patent**
Han

(10) **Patent No.:** **US D652,016 S**
(45) **Date of Patent:** **** Jan. 10, 2012**

(54) **MOBILE PHONE**

(75) Inventor: **Woo-Seung Han**, Seoul (KR)

(73) Assignee: **Samsung Electronics Co., Ltd.** (KR)

(**) Term: **14 Years**

(21) Appl. No.: **29/390,827**

(22) Filed: **Apr. 29, 2011**

(30) **Foreign Application Priority Data**

Mar. 9, 2011 (KR) 30-2011-0009583

(51) **LOC (9) Cl.** **14-03**

(52) **U.S. Cl.** **D14/138 AA**

(58) **Field of Classification Search** D14/138 AA,
D14/496, 341, 345, 346, 203.3, 203.4, 203.7,
D14/138 AB, 138 AD, 138 R, 147, 218, 137;
455/575.1, 556.2, 575.3, 575.4; D21/517;
379/433.01, 433.04, 433.11, 433.12, 433.13

See application file for complete search history.

(56) **References Cited**

U.S. PATENT DOCUMENTS

5,982,520	A *	11/1999	Weiser et al.	398/126
D489,368	S *	5/2004	Yoneda et al.	D14/345
D546,810	S *	7/2007	Kwak, II	D14/138 AA
D555,127	S *	11/2007	Park et al.	D14/138 AA
D561,153	S *	2/2008	Hong et al.	D14/138 AA
D572,697	S *	7/2008	Lee et al.	D14/138 AA
D584,269	S *	1/2009	Baik et al.	D14/138 AA
D598,887	S *	8/2009	Xiao et al.	D14/138 AA
D601,116	S *	9/2009	Baik et al.	D14/138 AA
D601,528	S *	10/2009	Lim et al.	D14/138 AA
D601,533	S *	10/2009	Youn et al.	D14/138 AA
D601,534	S *	10/2009	Youn et al.	D14/138 AA
D608,750	S *	1/2010	He et al.	D14/138 AA
D608,754	S *	1/2010	Zhou et al.	D14/138 AA
D612,349	S *	3/2010	Lee	D14/138 AA

D613,707	S *	4/2010	Park et al.	D14/138 AA
D615,088	S *	5/2010	Matsuoka	D14/439
D631,454	S *	1/2011	Cui	D14/138 AA
D633,458	S *	3/2011	Jinkinson et al.	D14/138 AA
7,911,773	B2 *	3/2011	Eromaki et al.	361/679.16
D637,988	S *	5/2011	Jinkinson	D14/138 AA
D637,991	S *	5/2011	Hu	D14/138 AA
D641,336	S *	7/2011	Chung	D14/138 AA
D643,394	S *	8/2011	Kao	D14/138 AA
2010/0267426	A1 *	10/2010	Kang et al.	455/575.1

OTHER PUBLICATIONS

Motorola Droid Pro XT610 telephone, announced Oct. 2010, [online], [site visited Aug. 23, 2011]. Available from Internet, <URL: <http://www.gsmarena.com>>.*

Sony Ericsson M608 telephone, announced May 2006, [online], [site visited Aug. 23, 2011]. Available from Internet, <URL: <http://www.gsmarena.com>>.*

Philips 399 telephone, announced Jul. 2007, [online], [site visited Aug. 23, 2011]. Available from Internet, <URL: <http://www.gsmarena.com>>.*

(Continued)

Primary Examiner — Jeffrey D Asch

(74) *Attorney, Agent, or Firm* — NSIP Law

(57) **CLAIM**

The ornamental design for a mobile phone, as shown and described.

DESCRIPTION

FIG. 1 is a perspective view of a mobile phone;
FIG. 2 is a front view of the mobile phone of FIG. 1;
FIG. 3 is a rear view of the mobile phone of FIG. 1;
FIG. 4 is a left-side view of the mobile phone of FIG. 1;
FIG. 5 is a right-side view of the mobile phone of FIG. 1;
FIG. 6 is a top plan view of the mobile phone of FIG. 1; and,
FIG. 7 is a bottom plan view of the mobile phone of FIG. 1.

1 Claim, 5 Drawing Sheets

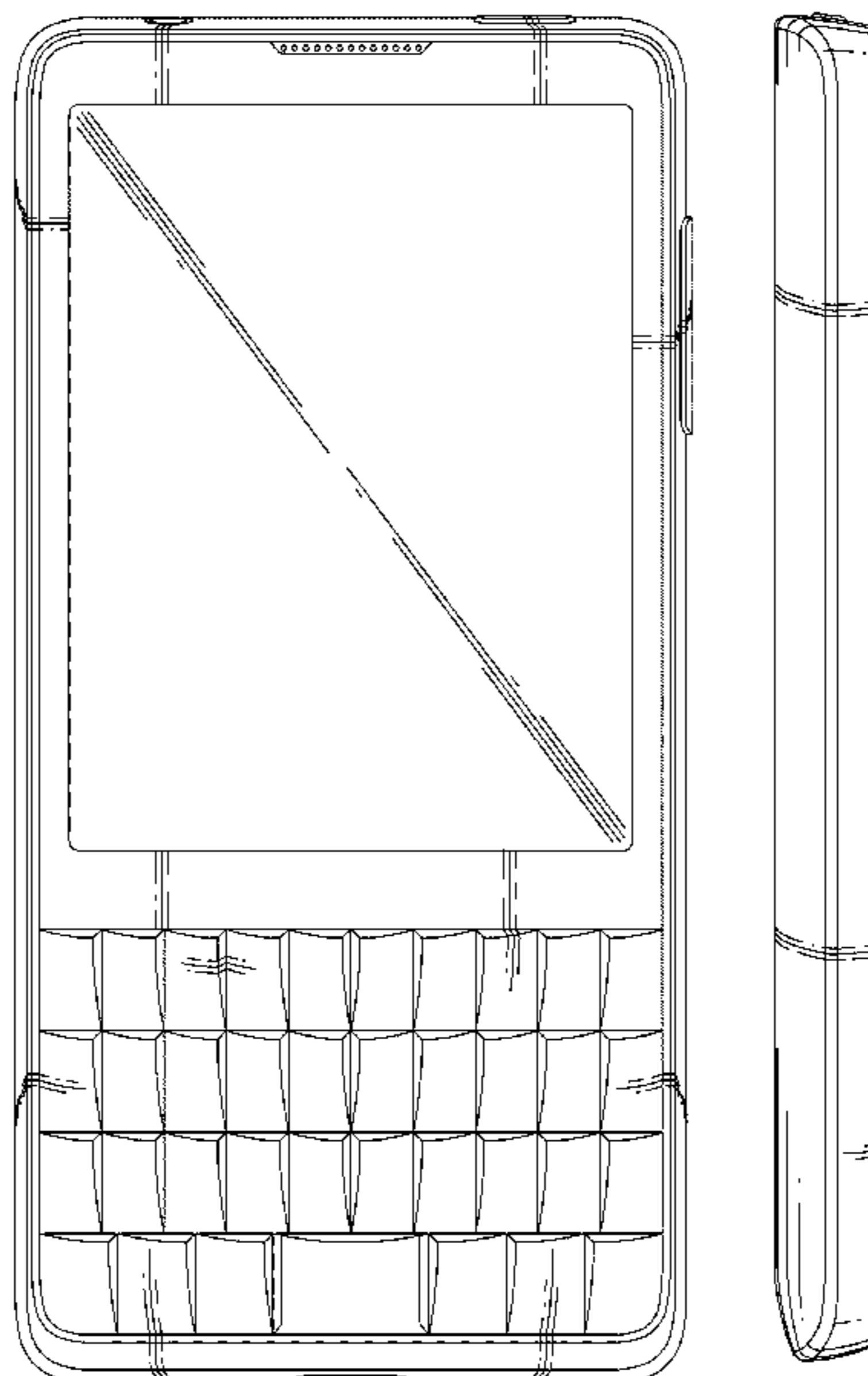

OTHER PUBLICATIONS

Philips 892 telephone, announced Aug. 2007, [online], [site visited Aug. 23, 2011]. Available from Internet, <URL: <http://www.gsmarena.com>>.*

Sony Ericsson P1 telephone, announced Jul. 2007, [online], [site visited Aug. 23, 2011]. Available from Internet, <URL: <http://www.gsmarena.com>>.*

Motorola Motokey XT EX118 telephone, announced Jul. 2011, [online], [site visited Aug. 23, 2011]. Available from Internet, <URL: <http://www.gsmarena.com>>.*

Sony Ericsson W950 telephone, announced Feb. 2006, [online], [site visited Aug. 23, 2011]. Available from Internet, <URL: <http://www.gsmarena.com>>.*

Sagem P9522 Porsche telephone, announced Oct. 2008, [online], [site visited Aug. 23, 2011]. Available from Internet, <URL: <http://www.gsmarena.com>>.*

Sony Ericsson W960 telephone, announced Dec. 2007, [online], [site visited Aug. 23, 2011]. Available from Internet, <URL: <http://www.gsmarena.com>>.*

* cited by examiner

FIG. 1

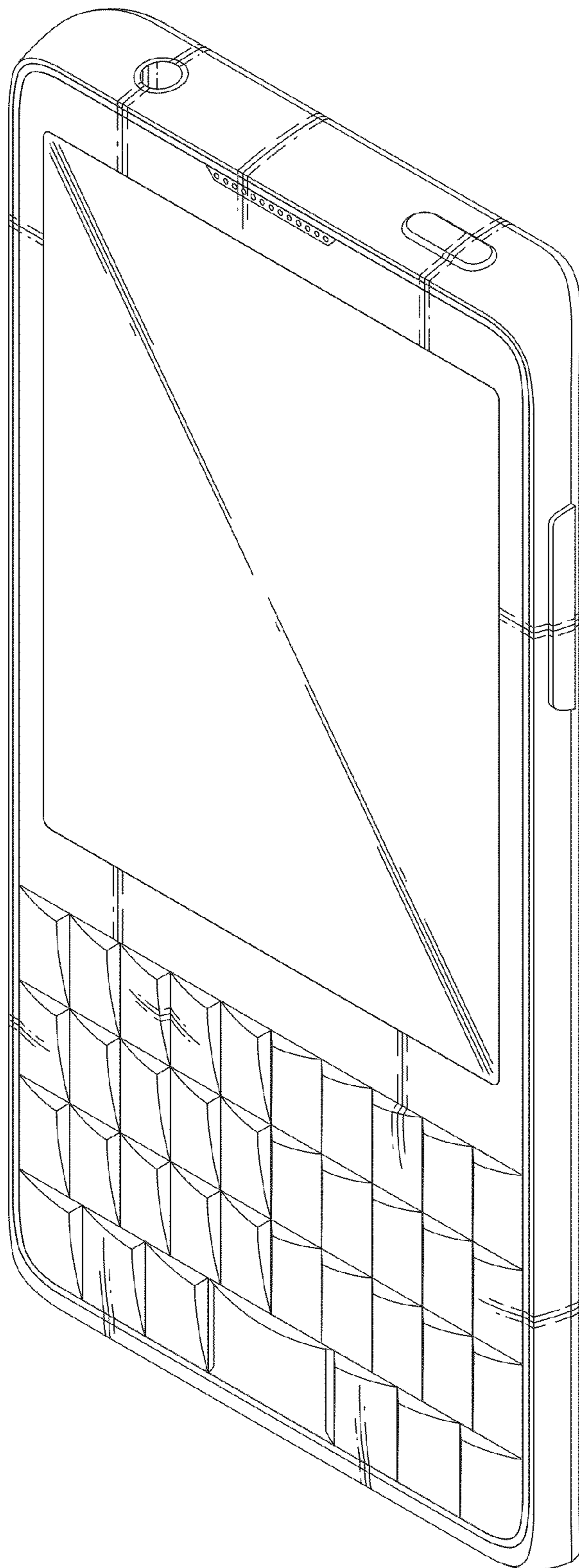

FIG. 2

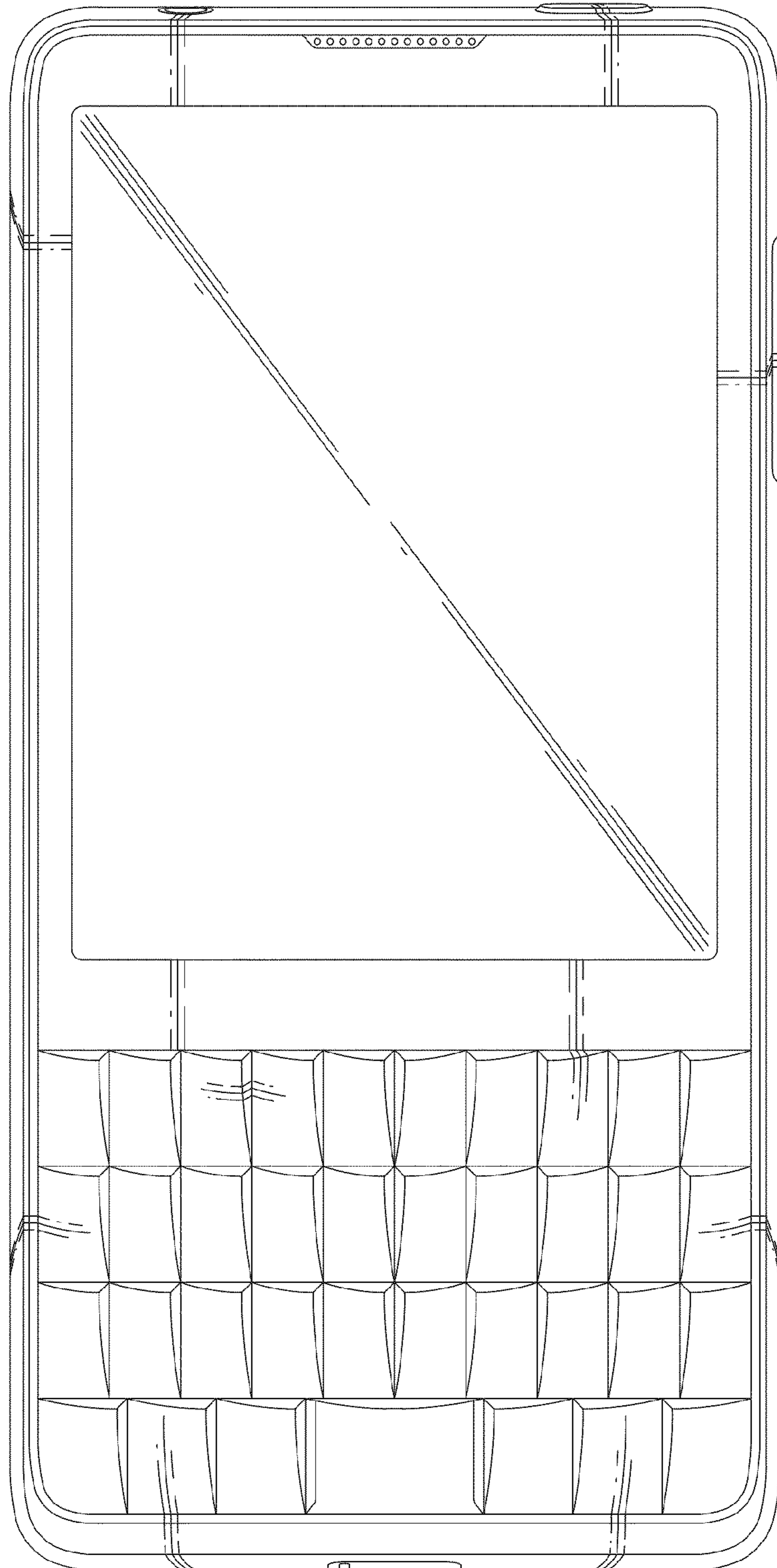

FIG. 3

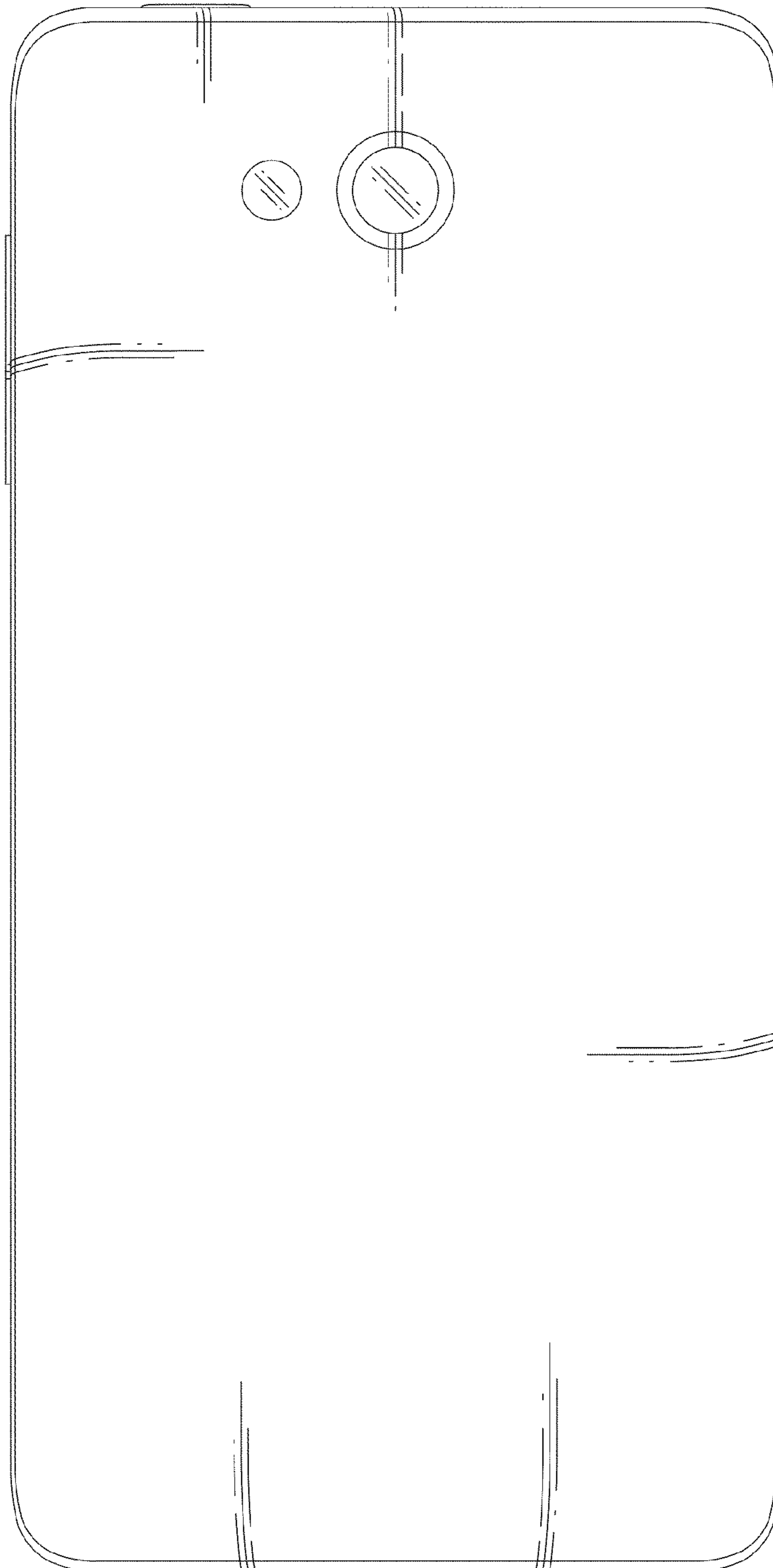

FIG. 4

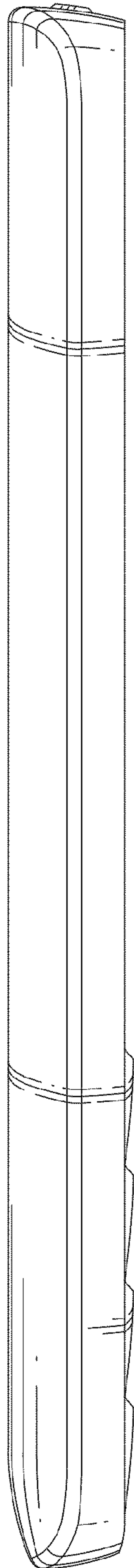

FIG. 5

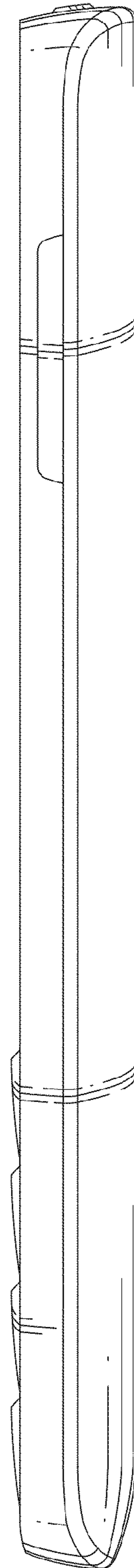

FIG. 6

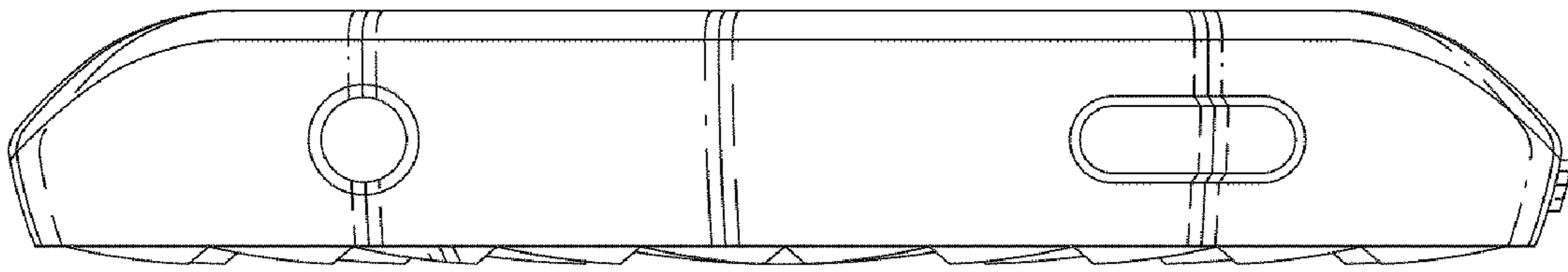

FIG. 7

