



US00D651984S

(12) **United States Design Patent**
Feldstein et al.

(10) **Patent No.:** **US D651,984 S**
(45) **Date of Patent:** **** *Jan. 10, 2012**

- (54) **WALL MOUNTED BUTTON PANEL**
- (75) Inventors: **George Feldstein**, Cresskill, NJ (US);
Stan Wisniewski, Pompton Plains, NJ (US)
- (73) Assignee: **Crestron Electronics Inc.**, Rockleigh, NJ (US)

- D313,738 S 1/1991 Mayo et al.
- D319,429 S 8/1991 D'Aleo et al.
- D327,255 S 6/1992 D'Aleo et al.
- D331,741 S * 12/1992 Fujiyoshi D13/169
- D331,742 S * 12/1992 Fujiyoshi D13/169
- D331,743 S * 12/1992 Fujiyoshi D13/169
- D336,744 S 6/1993 Kahn et al.
- 5,260,669 A 11/1993 Higgins et al.
- D344,264 S 2/1994 D'Aleo et al.
- 5,289,043 A 2/1994 Marshall et al.

(*) Notice: This patent is subject to a terminal disclaimer.

(**) Term: **14 Years**

(21) Appl. No.: **29/385,141**

(22) Filed: **Feb. 9, 2011**

Related U.S. Application Data

(63) Continuation-in-part of application No. 29/354,992, filed on Feb. 1, 2010.

(51) **LOC (9) Cl.** **13-03**

(52) **U.S. Cl.** **D13/164; D13/171**

(58) **Field of Classification Search** D13/162, D13/164, 171, 174; 200/5 R, 5 A, 520, 530, 200/293, 296, 302.2, 308, 310, 314, 329, 200/341; 307/139, 157; 315/209 R, 224, 315/246, 291, 294, 295

See application file for complete search history.

(56) **References Cited**

U.S. PATENT DOCUMENTS

- 4,529,951 A 7/1985 Youichi
- D285,066 S 8/1986 Liss et al.
- D287,242 S 12/1986 Liss et al.
- 4,716,357 A 12/1987 Cooper
- 4,728,866 A 3/1988 Capewell
- 4,876,498 A 10/1989 Luchaco
- 4,888,494 A 12/1989 McNair et al.
- 4,954,768 A 9/1990 Luchaco et al.
- D311,382 S 10/1990 Mayo et al.
- D311,485 S 10/1990 Jacoby et al.
- D311,678 S 10/1990 Graef et al.

(Continued)

OTHER PUBLICATIONS

Crestron Electronics, Inc., Cameo Keypads Operations and Installation Guide, Feb. 2006, pp. front, cover, i, 1-8, rear cover.

Primary Examiner — Selina Sikder

(57) **CLAIM**

The ornamental design for a wall mounted button panel, as shown and described.

DESCRIPTION

FIG. 1 shows a front elevational view of a wall mounted button panel, with elements in dashed lines forming no part of the claimed design.

FIG. 2 shows an isometric projection of the wall mounted button panel, with elements in dashed lines forming no part of the claimed design.

FIG. 3 shows a left side elevational view of the wall mounted button panel, with elements in dashed lines forming no part of the claimed design.

FIG. 4 shows a right side elevational view of the wall mounted button panel, with elements in dashed lines forming no part of the claimed design.

FIG. 5 shows a top plan view of the wall mounted button panel, with elements in dashed lines forming no part of the claimed design; and,

FIG. 6 shows a bottom plan view of the wall mounted button panel, with elements in dashed lines forming no part of the claimed design.

1 Claim, 4 Drawing Sheets

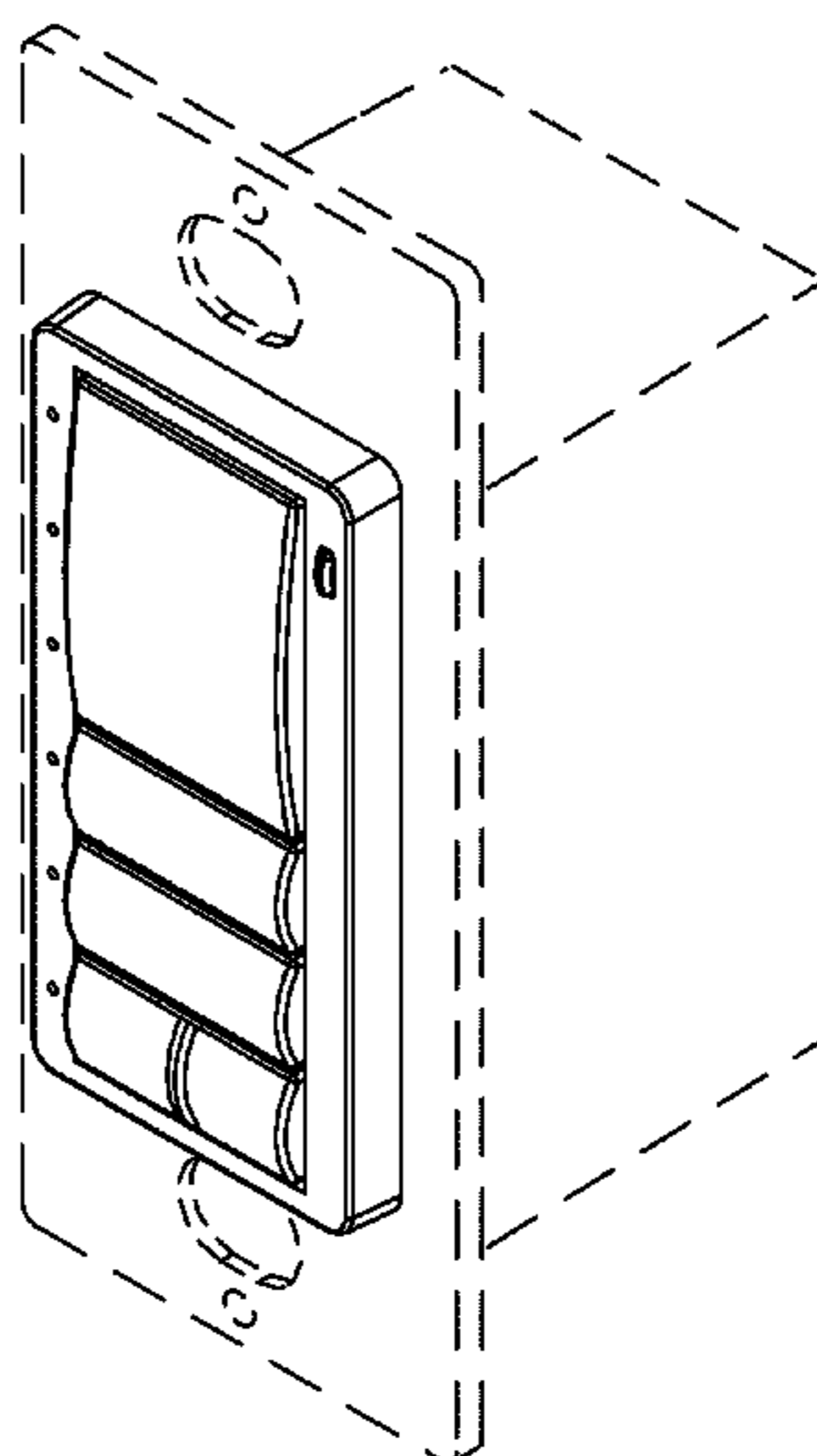

US D651,984 S

U.S. PATENT DOCUMENTS					
5,293,308	A	3/1994	Boys et al.	D551,177	S 9/2007 Larson et al.
D353,798	S	12/1994	Bryde	D551,178	S 9/2007 Mayo et al.
5,399,926	A	3/1995	Adams et al.	D551,179	S 9/2007 Mayo et al.
5,430,356	A	7/1995	Ference	D551,630	S 9/2007 Larson et al.
5,463,286	A	10/1995	D'Aleo et al.	D551,631	S 9/2007 Mayo et al.
5,485,058	A *	1/1996	Watson et al. 315/194	D552,042	S 10/2007 Mayo et al.
5,608,196	A	3/1997	Hall	D557,662	S 12/2007 Spira
5,670,858	A	9/1997	Heath	D557,664	S 12/2007 Hewson et al.
D389,461	S	1/1998	Mayo et al.	D557,665	S 12/2007 Hewson et al.
D389,805	S	1/1998	Mayo et al.	D572,664	S 7/2008 Hollner et al.
D395,037	S	6/1998	Mayo et al.	D572,665	S 7/2008 Hollner et al.
D404,013	S	1/1999	Mayo et al.	D572,666	S 7/2008 Biery et al.
5,903,139	A	5/1999	Kompelien	D573,546	S 7/2008 Hollner
D412,315	S	7/1999	Mayo et al.	D573,956	S 7/2008 Hollner et al.
D421,246	S	2/2000	Mayo et al.	D574,787	S 8/2008 Hollner
D422,567	S	4/2000	Mayo	D576,958	S 9/2008 Hollner
6,091,205	A	7/2000	Newman, Jr. et al.	D580,881	S 11/2008 Hollner
D428,855	S	8/2000	Mayo et al.	D580,882	S 11/2008 Hollner
6,120,262	A	9/2000	McDonough et al.	D580,883	S 11/2008 Hollner
D436,930	S	1/2001	Butler	D580,884	S 11/2008 Hollner
D437,585	S	2/2001	Mayo	D585,840	S 2/2009 Hollner
D437,834	S	2/2001	Mayo et al.	D585,841	S 2/2009 Hollner
6,218,787	B1	4/2001	Murcko et al.	D586,760	S 2/2009 Hollner et al.
D441,723	S	5/2001	Mayo et al.	D588,070	S 3/2009 Hollner et al.
D442,558	S	5/2001	Mayo et al.	D588,071	S 3/2009 Hollner et al.
D450,043	S	11/2001	Mosebrook	D588,072	S 3/2009 Hollner et al.
D453,742	S	2/2002	Butler	D588,073	S 3/2009 Hollner et al.
6,356,038	B2	3/2002	Bishel	D588,074	S 3/2009 Hollner
6,380,696	B1 *	4/2002	Sembhi et al. 315/294	D588,075	S 3/2009 Hollner
D456,783	S	5/2002	Mayo et al.	D588,553	S 3/2009 Hollner et al.
D461,782	S	8/2002	Butler et al.	D595,663	S 7/2009 Hollner
D465,460	S	11/2002	Mayo	D595,665	S 7/2009 Hollner
D466,090	S	11/2002	Bennett	D595,666	S 7/2009 Hollner
D466,091	S	11/2002	Bennett	D596,140	S 7/2009 Hollner
D466,484	S	12/2002	Bennett	7,609,007	B1 10/2009 Kumar
6,545,434	B2	4/2003	Sembhi et al.	D604,743	S 11/2009 Altonen et al.
D475,024	S	5/2003	Bennett	D612,400	S 3/2010 Altonen et al.
D475,025	S	5/2003	Bennett	D613,305	S 4/2010 Altonen et al.
D490,061	S	5/2004	Bennett	7,796,057	B2 * 9/2010 Swatsky et al. 341/23
D510,074	S	9/2005	Larson et al.	D624,881	S 10/2010 Altonen et al.
6,969,959	B2	11/2005	Black et al.	D624,882	S 10/2010 Altonen et al.
D516,041	S	2/2006	Hobart et al.	D625,273	S * 10/2010 Felegy et al. D13/168
D519,939	S *	5/2006	Hedderich et al. D13/164	D633,448	S 3/2011 Biery et al.
D535,950	S	1/2007	Alker et al.	D636,738	S * 4/2011 Feldstein et al. D13/164
D538,238	S	3/2007	Alker et al.	7,928,663	B1 4/2011 Kumar
D539,758	S	4/2007	Blair et al.	2002/0060530	A1 5/2002 Sembhi
D542,226	S	5/2007	Spira	2002/0067144	A1 * 6/2002 Hoffknecht et al. 315/291
D542,227	S	5/2007	Larson et al.	2005/0275354	A1 12/2005 Hausman et al.
D542,229	S	5/2007	Larson et al.	2005/0284738	A1 12/2005 Altonen
D543,158	S *	5/2007	Blair et al. D13/162	2006/0255745	A1 11/2006 DeJonge
D546,294	S	7/2007	Mayo et al.	2007/0001654	A1 1/2007 Newman
D546,776	S	7/2007	Mierta et al.	2007/0285027	A1 12/2007 Gehman
D547,733	S	7/2007	Mayo et al.	2008/0024074	A1 1/2008 Mosebrook
D547,734	S	7/2007	Mayo et al.	2008/0111501	A1 5/2008 Dobbins et al.
D550,163	S	9/2007	Mayo et al.	2008/0237010	A1 10/2008 Patel et al.
D550,164	S	9/2007	Mayo et al.	2009/0039854	A1 2/2009 Blakely
D550,165	S	9/2007	Mayo et al.	2009/0108765	A1 4/2009 Weightman et al.
D550,166	S	9/2007	Mayo et al.	2010/0214756	A1 8/2010 Feldstein

* cited by examiner

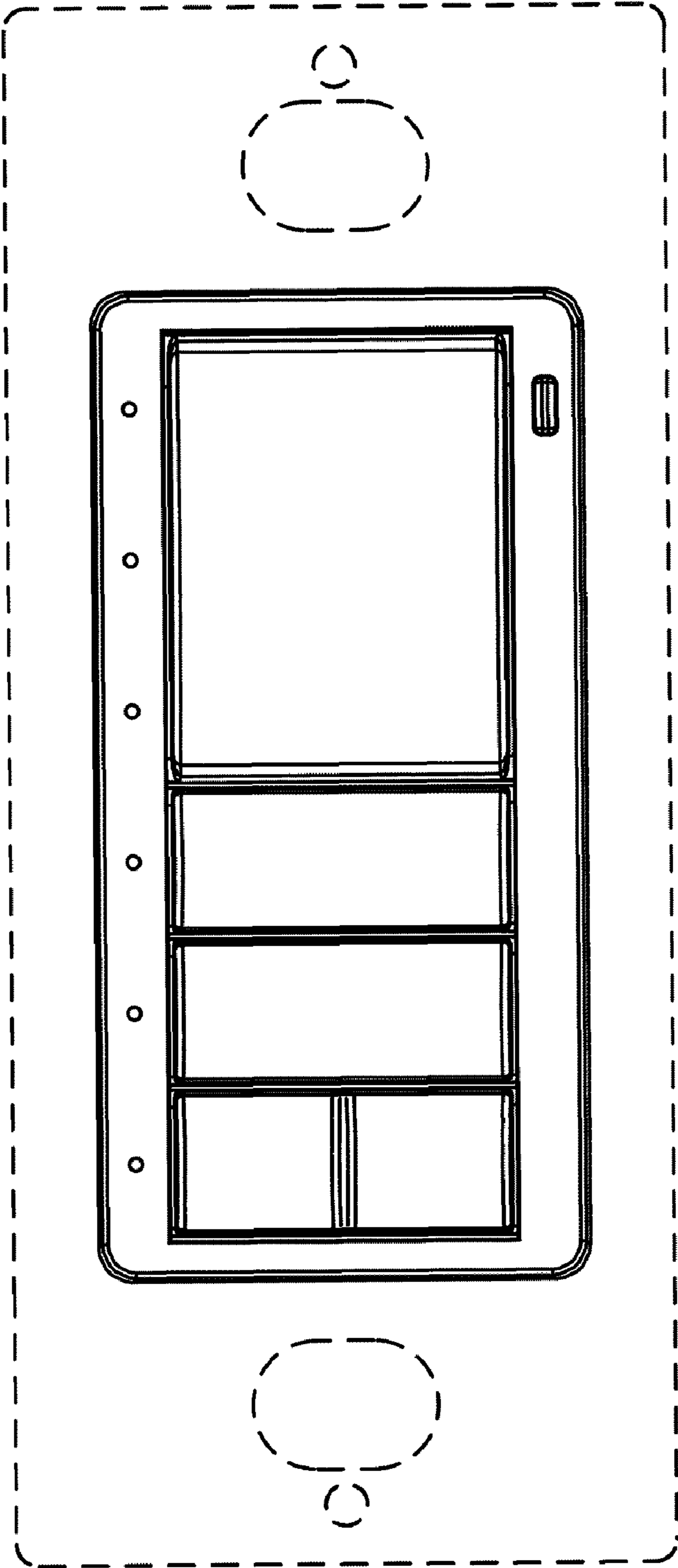

FIG. 1

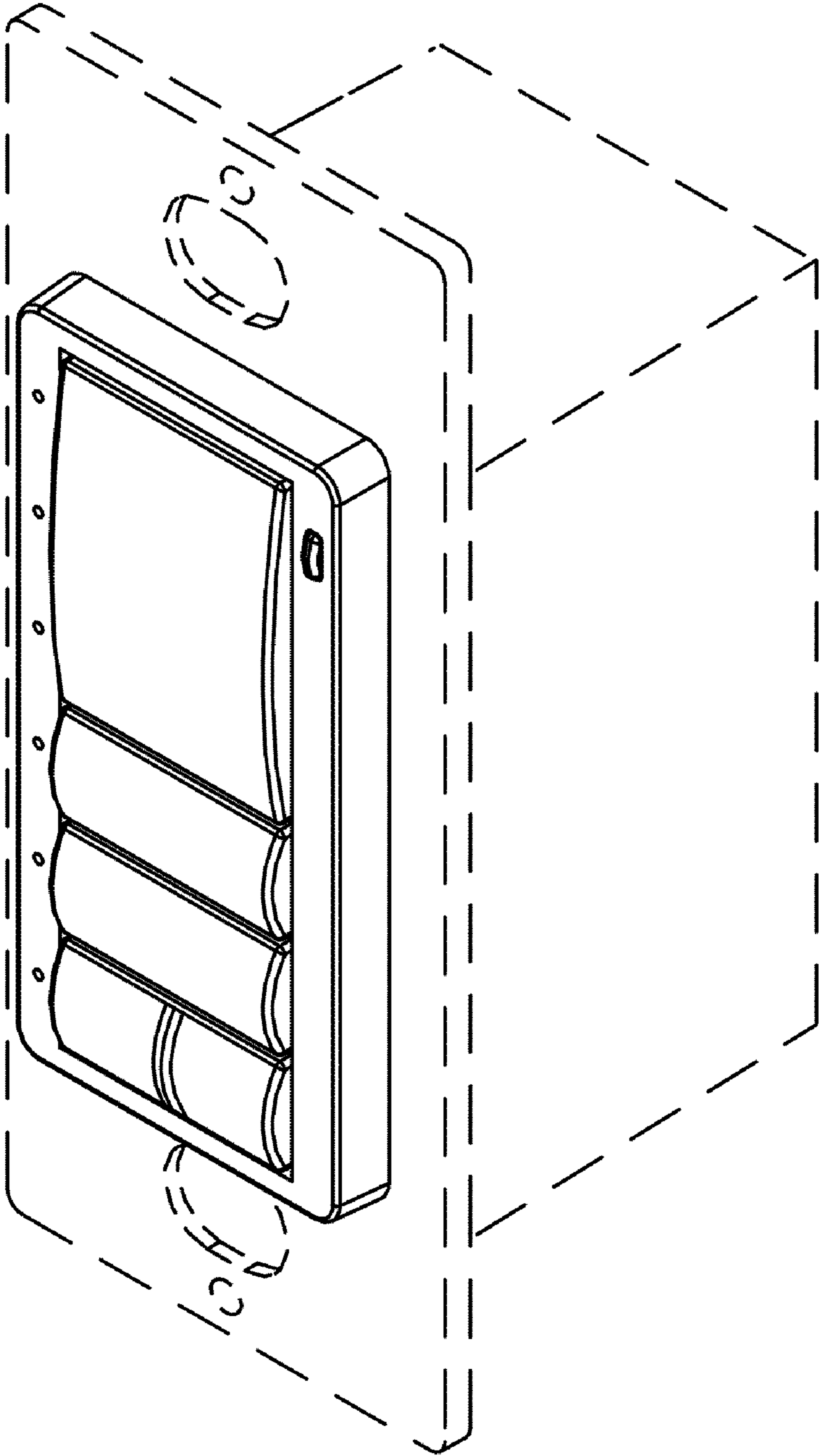

FIG. 2

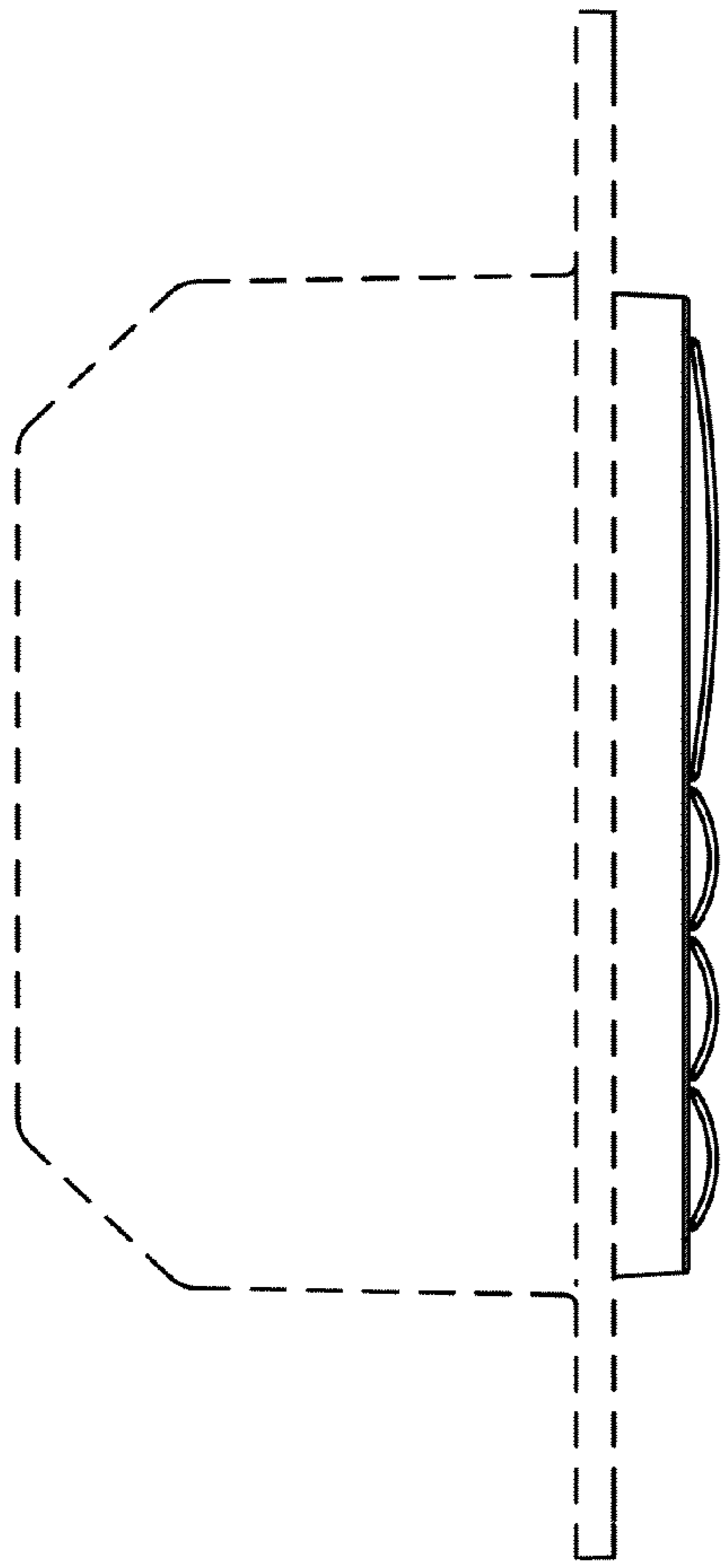

FIG. 3

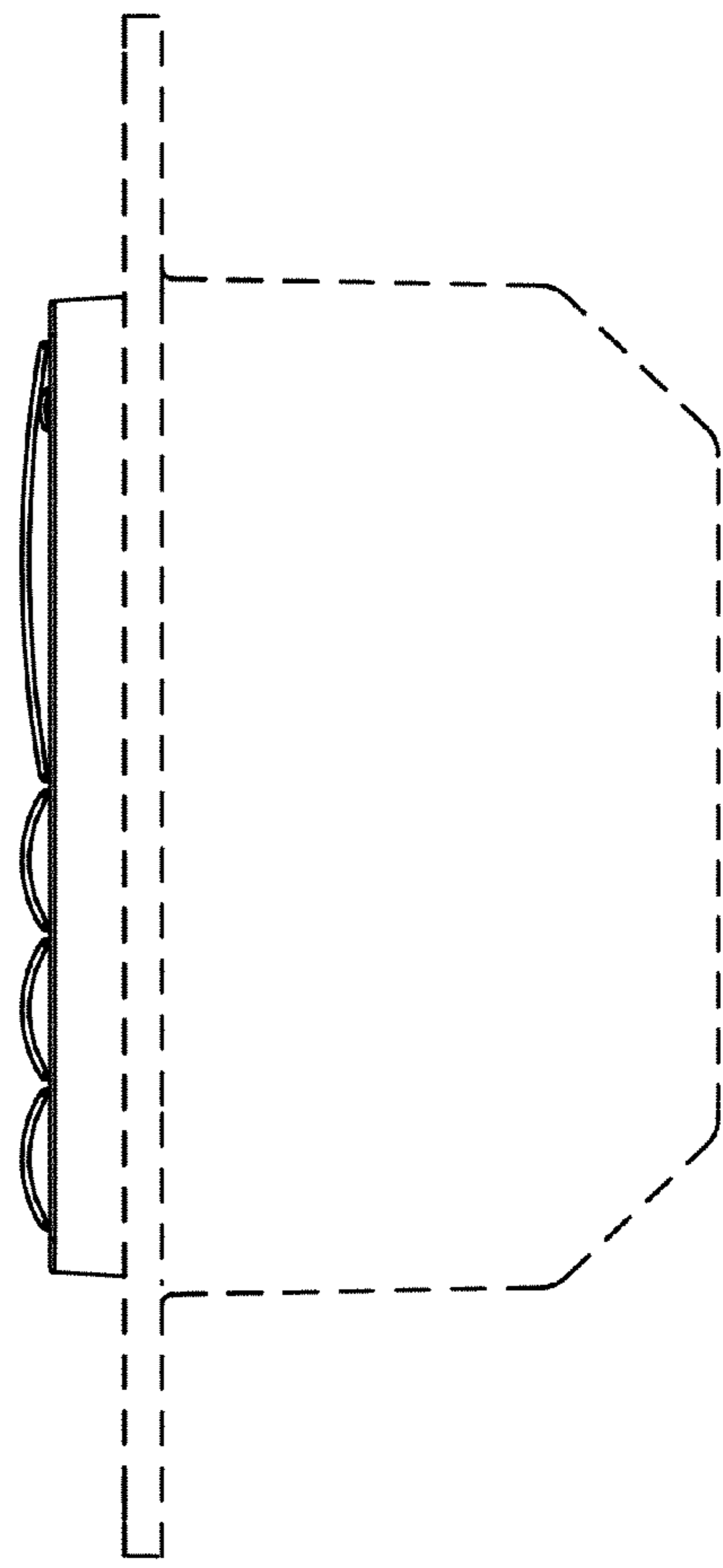

FIG. 4

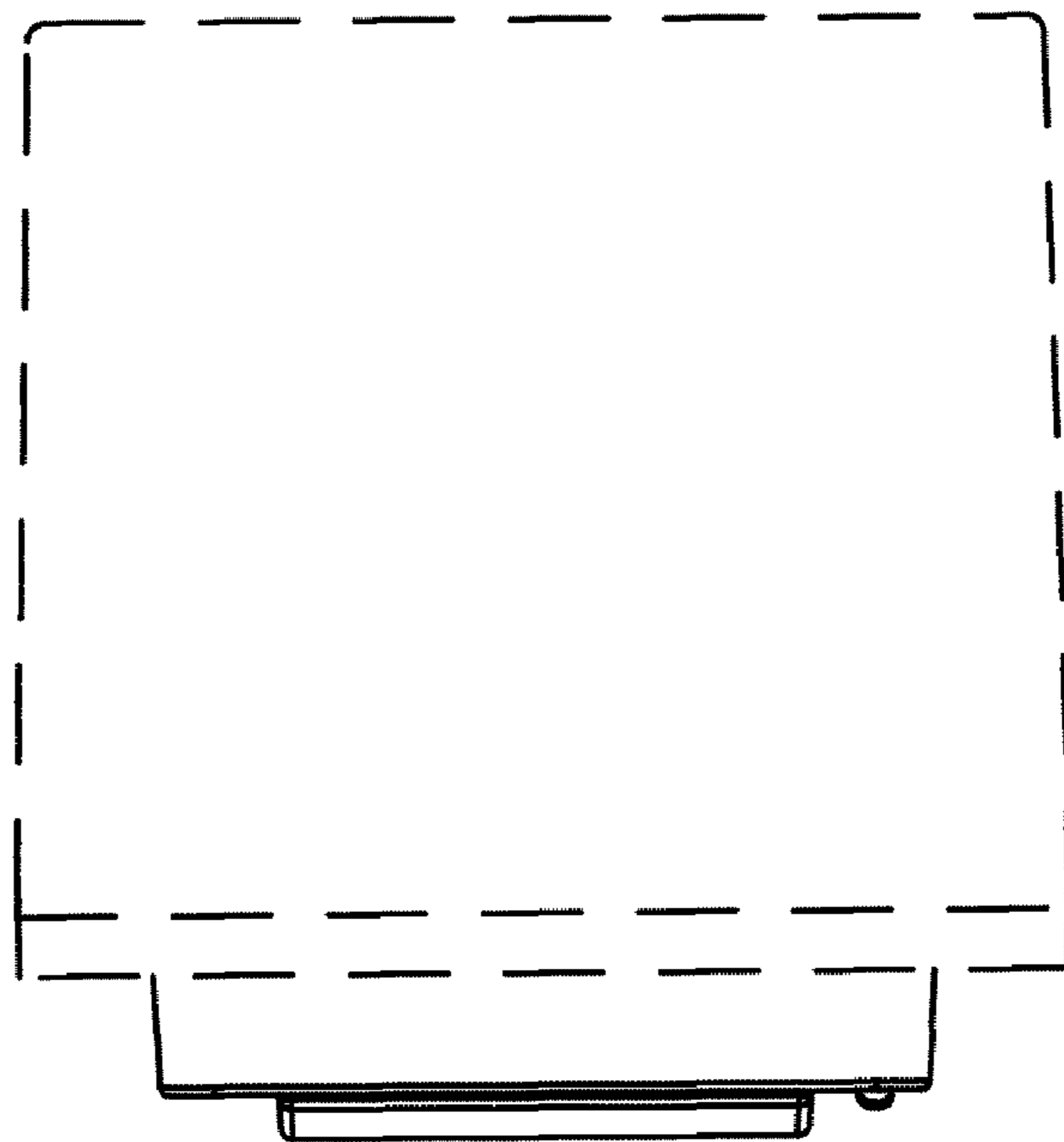

FIG. 5

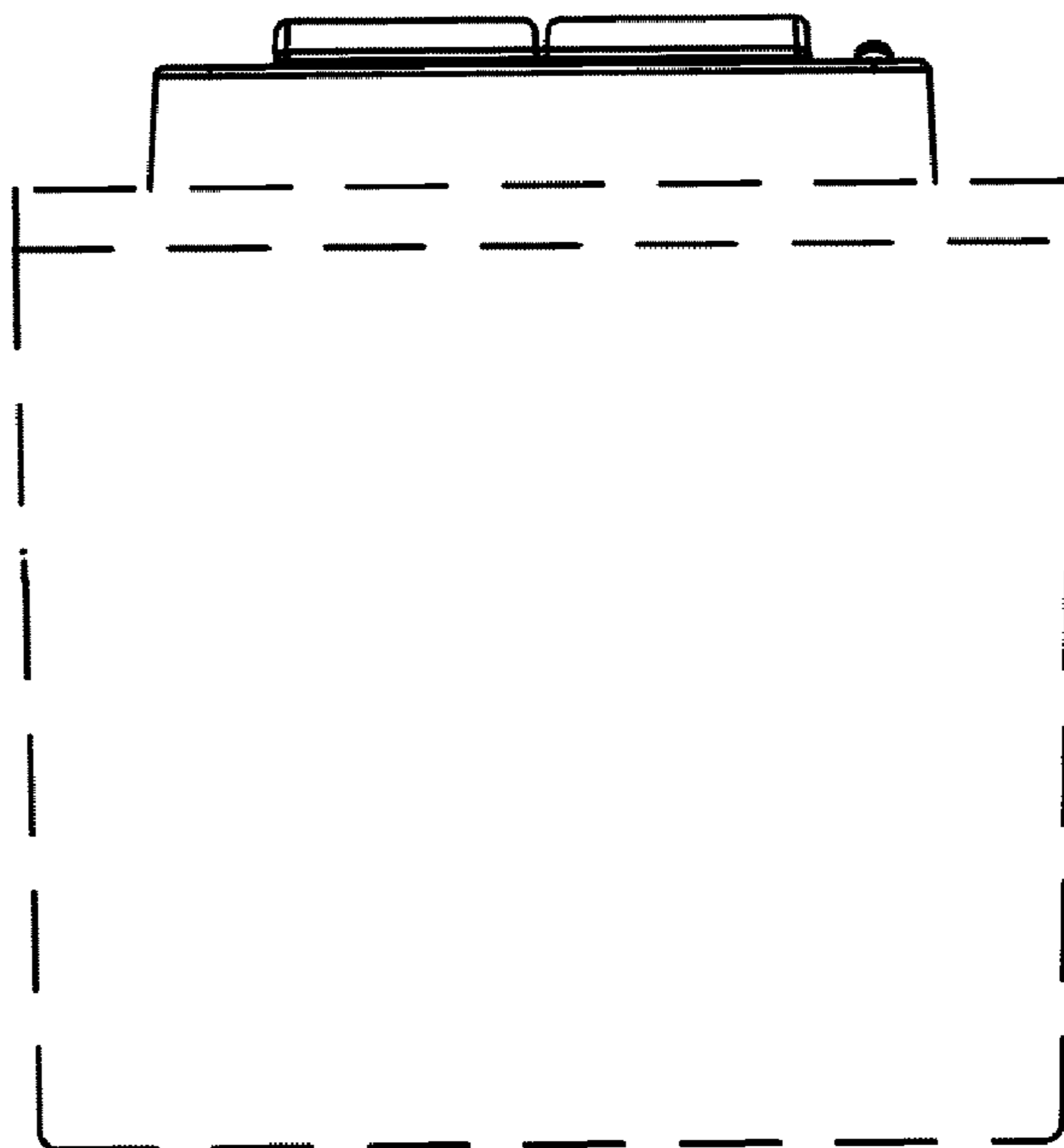

FIG. 6