



US00D651937S

(12) **United States Design Patent**
Hashimoto

(10) **Patent No.:** **US D651,937 S**
(45) **Date of Patent:** **** Jan. 10, 2012**

(54) **INDOOR AND OUTDOOR DECORATIVE ARTICLE**

(75) Inventor: **Masaki Hashimoto**, Ibaraki (JP)
(73) Assignee: **Suntory Holdings Limited**, Osaka (JP)
(**) Term: **14 Years**
(21) Appl. No.: **29/361,150**
(22) Filed: **May 6, 2010**
(30) **Foreign Application Priority Data**

Nov. 10, 2009 (JP) 2009-026261
(51) **LOC (9) Cl.** **11-02**
(52) **U.S. Cl.** **D11/143**
(58) **Field of Classification Search** D6/403-405,
D6/556-558; D8/1; D11/143-156, 164;
D19/77, 80, 81, 84; D25/100; D26/9-11,
D26/16, 19; D34/1, 2, 4-6; D99/5, 19; 47/17,
47/32.4, 32.5, 32.7, 33, 39, 41.01, 41.1, 41.11-41.15,
47/44-47, 65, 65.5, 65.9, 66.1, 66.2, 66.6,
47/66.7, 67-71, 82, 83, 86, 87
See application file for complete search history.

(56) **References Cited**

U.S. PATENT DOCUMENTS
152,758 A * 7/1874 Ullman 47/86
986,395 A * 3/1911 King 47/33
2,830,405 A * 4/1958 Nydegger D11/155
(Continued)

Primary Examiner — Garth Rademaker
(74) *Attorney, Agent, or Firm* — Greenblum & Bernstein P.L.C.

(57) **CLAIM**
The ornamental design for an indoor and outdoor decorative article, as shown and described.

DESCRIPTION

FIG. 1 is a front elevation view of an indoor and outdoor decorative article showing my new design;

FIG. 2 is a rear elevation view thereof;
FIG. 3 is a left side elevation view thereof;
FIG. 4 is a right side elevation view thereof;
FIG. 5 is a top plan view thereof;
FIG. 6 is a bottom plan view thereof;
FIG. 7 is a top plan view thereof, shown at an enlarged scale;
FIG. 8 is a front elevation view thereof, shown in an alternate position of use;
FIG. 9 is a top plan view thereof, shown positioned as in FIG. 8;
FIG. 10 is a top plan view thereof, shown in another alternate position of use;
FIG. 11 is a front elevation view thereof, showing section 11 of FIG. 1 at an enlarged scale;
FIG. 12 is a right side elevation view thereof, showing section 12 of FIG. 4 at an enlarged scale;
FIG. 13 is a front elevation view thereof, showing section 13 of FIG. 8 at an enlarged scale;
FIG. 14 is a perspective view of one of the elements forming the top row of the design, shown at an enlarged scale, each element forming the top row thereof being identical thereto;
FIG. 15 is a perspective view of one of the elements beneath the top row of the design, shown at an enlarged scale, each element beneath the top row of the design being identical thereto;
FIG. 16 is a perspective view of the indoor and outdoor decorative article, shown positioned as in FIG. 1 and in an environment of use; and,
FIG. 17 is a perspective view thereof, shown positioned as in FIG. 8 and in an environment of use.
The broken lines in the figures depict environmental subject matter only and form no part of the claimed design.
The indoor and outdoor decorative article is intended to hold ornamental articles, such as a plant or artificial flower. It pivots along each vertical axis, as shown in FIGS. 5, 9, and 10, and can be placed on a base, as shown in FIGS. 16 and 17.

1 Claim, 17 Drawing Sheets

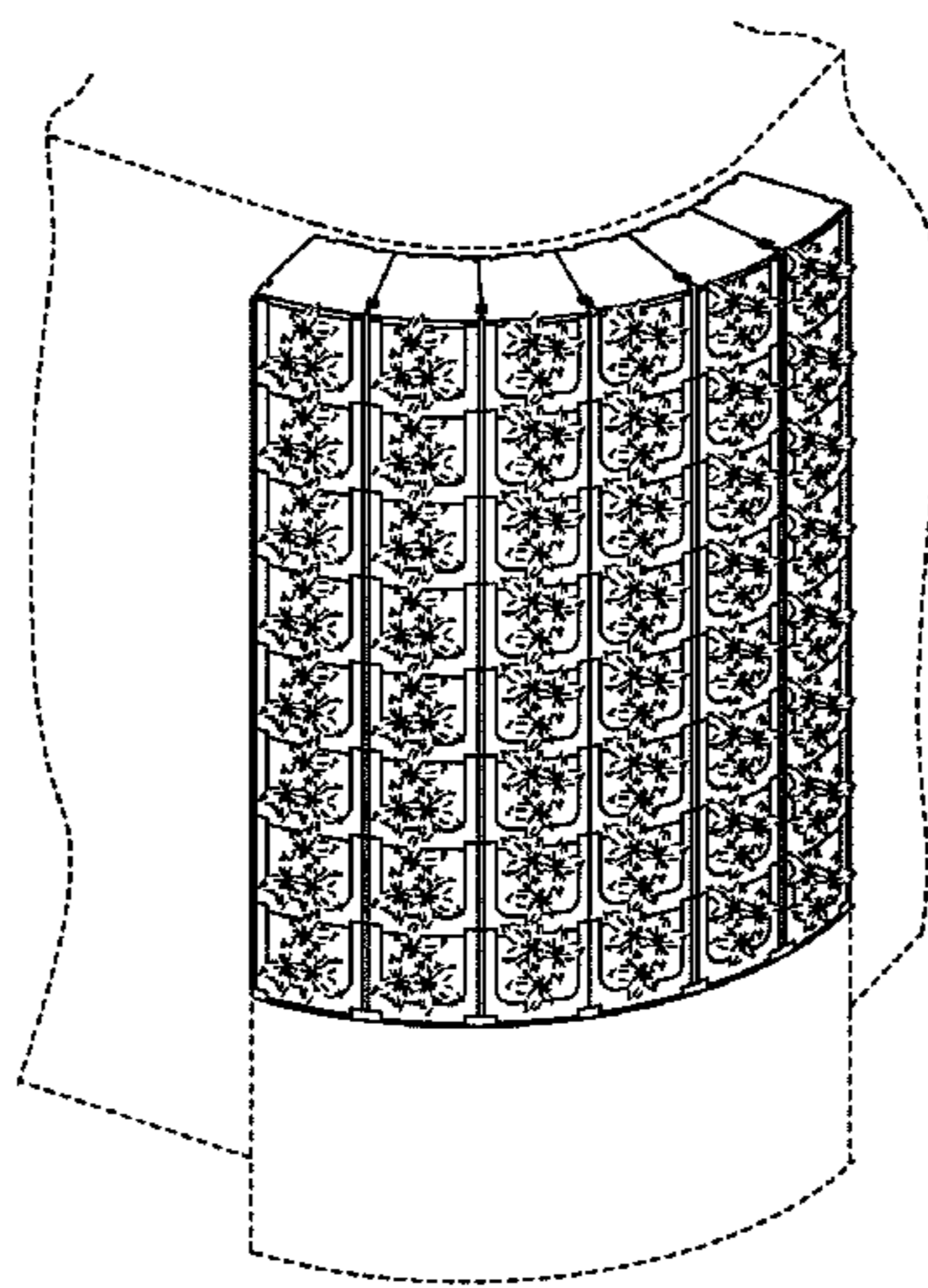

US D651,937 S

Page 2

U.S. PATENT DOCUMENTS

4,059,922	A *	11/1977	DiGiacinto	47/82	2007/0084107	A1 *	4/2007	Ganti	47/39
D250,158	S *	11/1978	Kelly	D6/468	2009/0223126	A1 *	9/2009	Garner et al.	47/66.7
5,363,594	A *	11/1994	Davis	47/82	2009/0293351	A1 *	12/2009	De Pagter et al.	47/41.12
6,615,542	B2 *	9/2003	Ware	47/83	2010/0095586	A1 *	4/2010	Sichello	47/65.9
D620,218	S *	7/2010	Larin	D34/1	2010/0095588	A1 *	4/2010	Hashimoto	47/82

* cited by examiner

Fig. 1

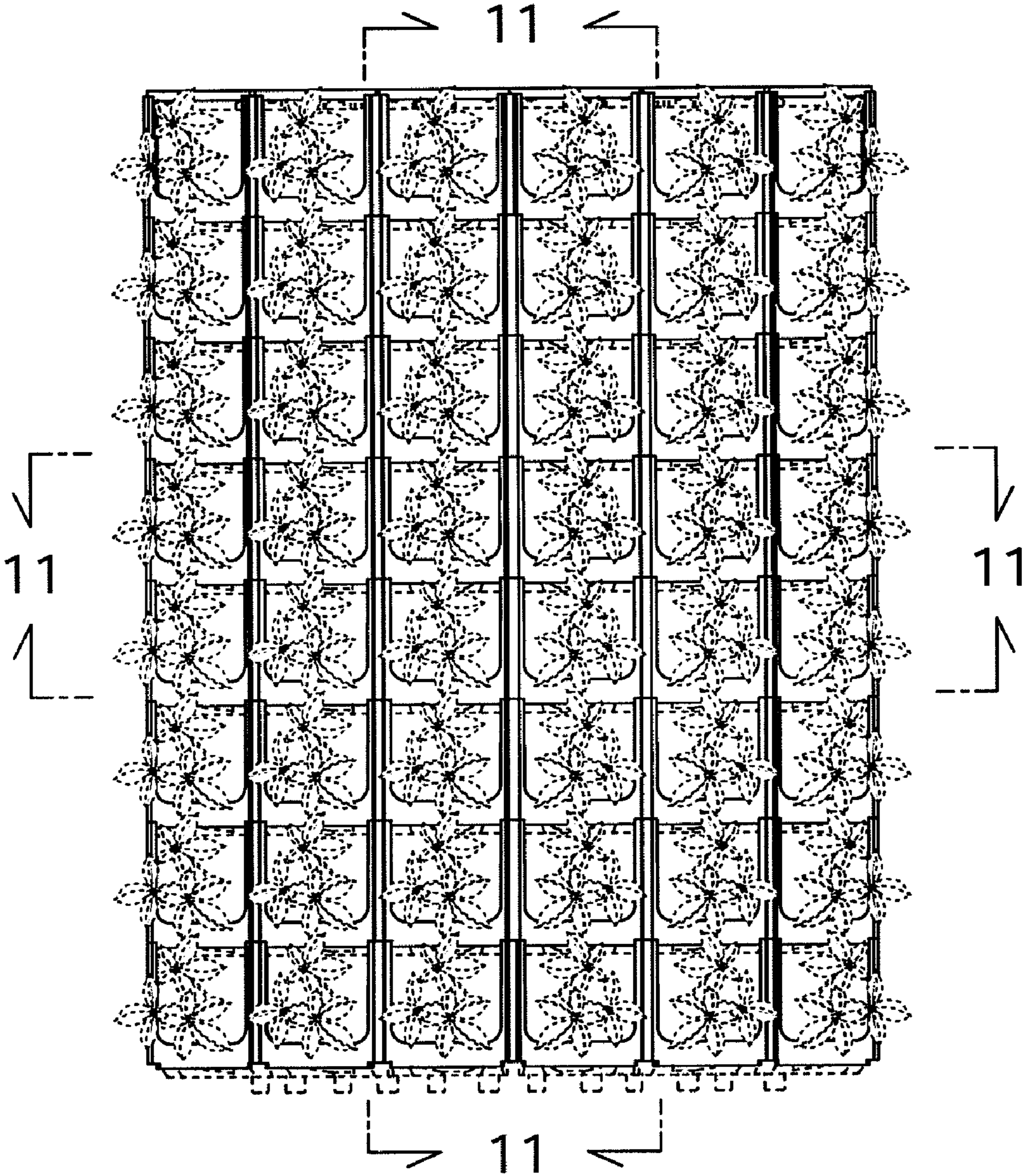

Fig. 2

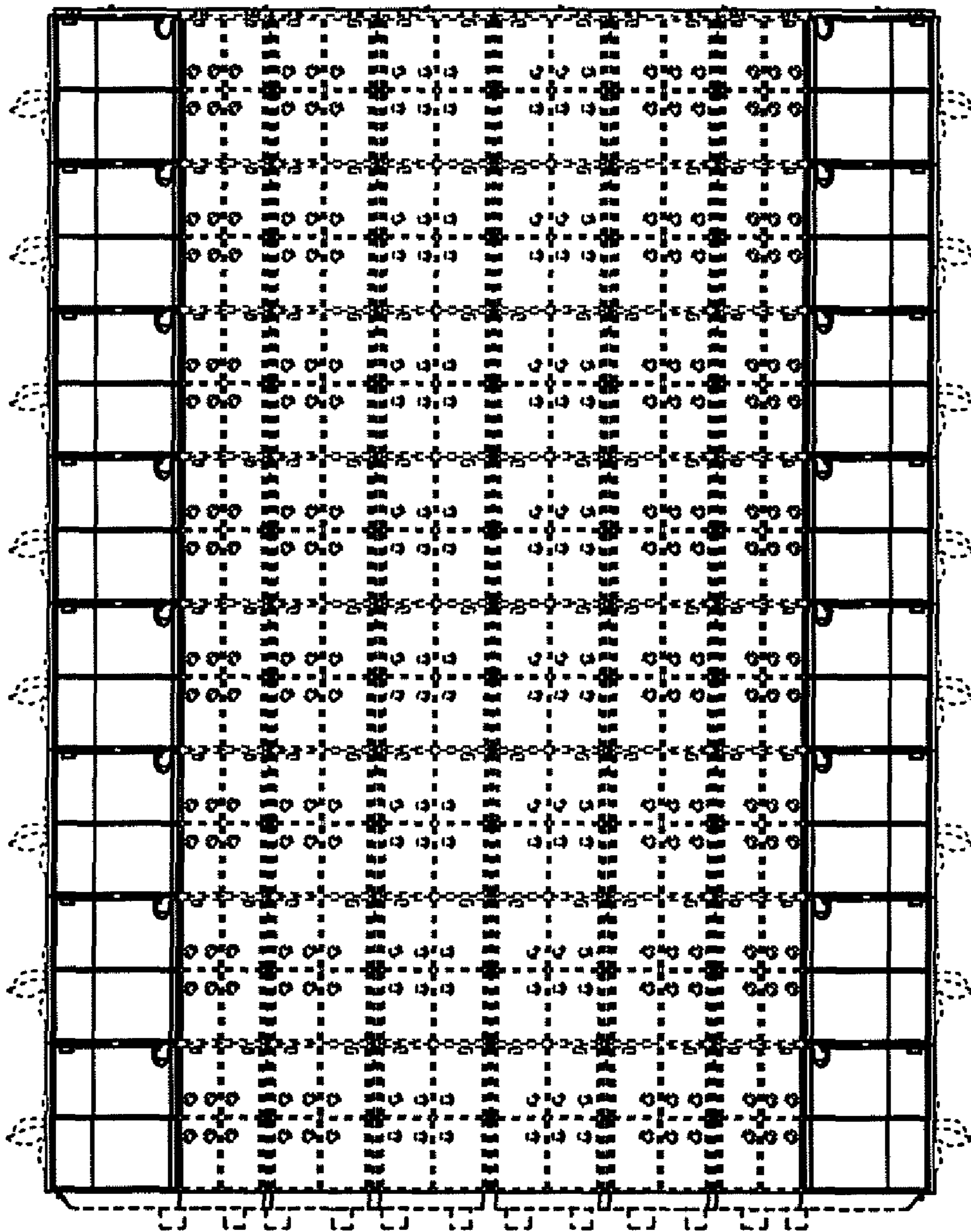

Fig. 3

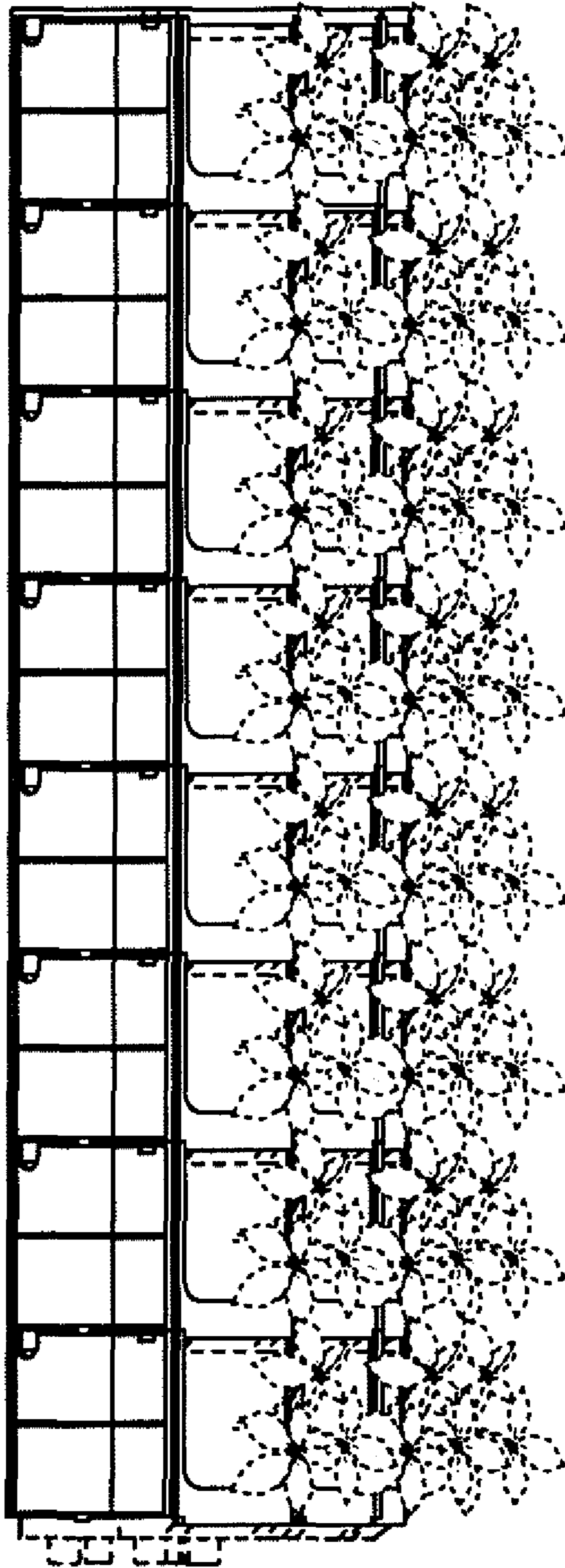

Fig. 4

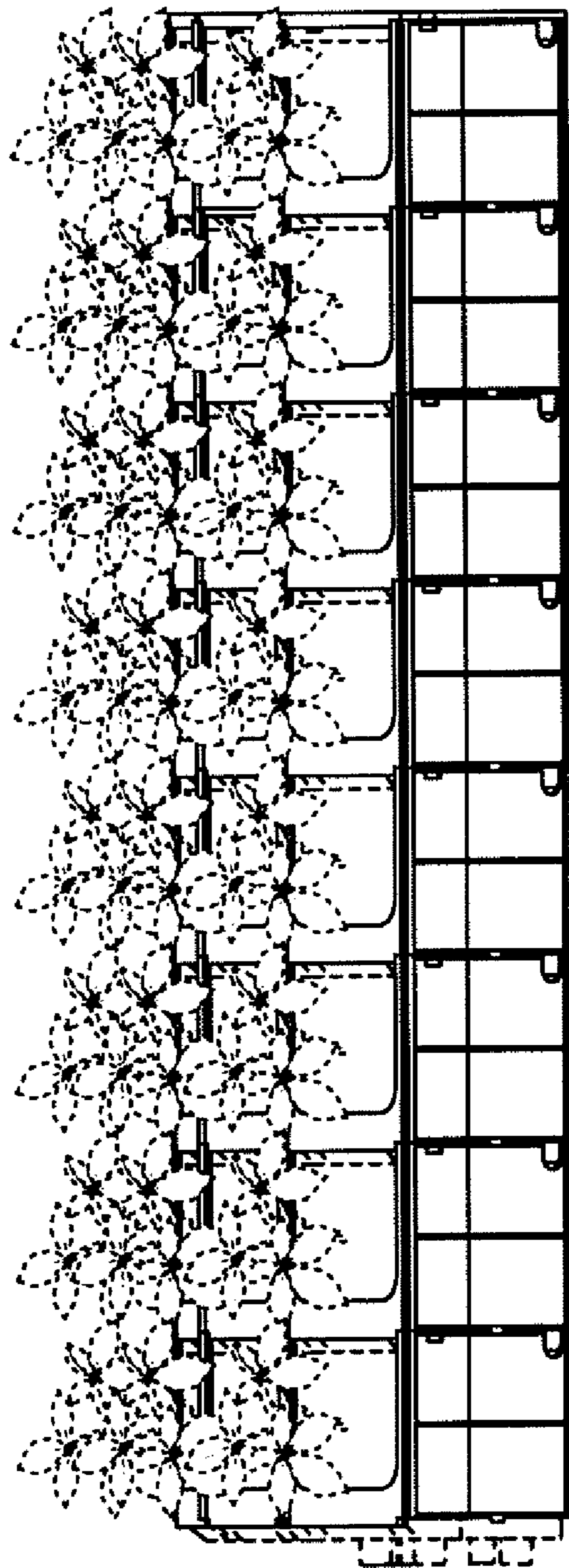

Fig. 5

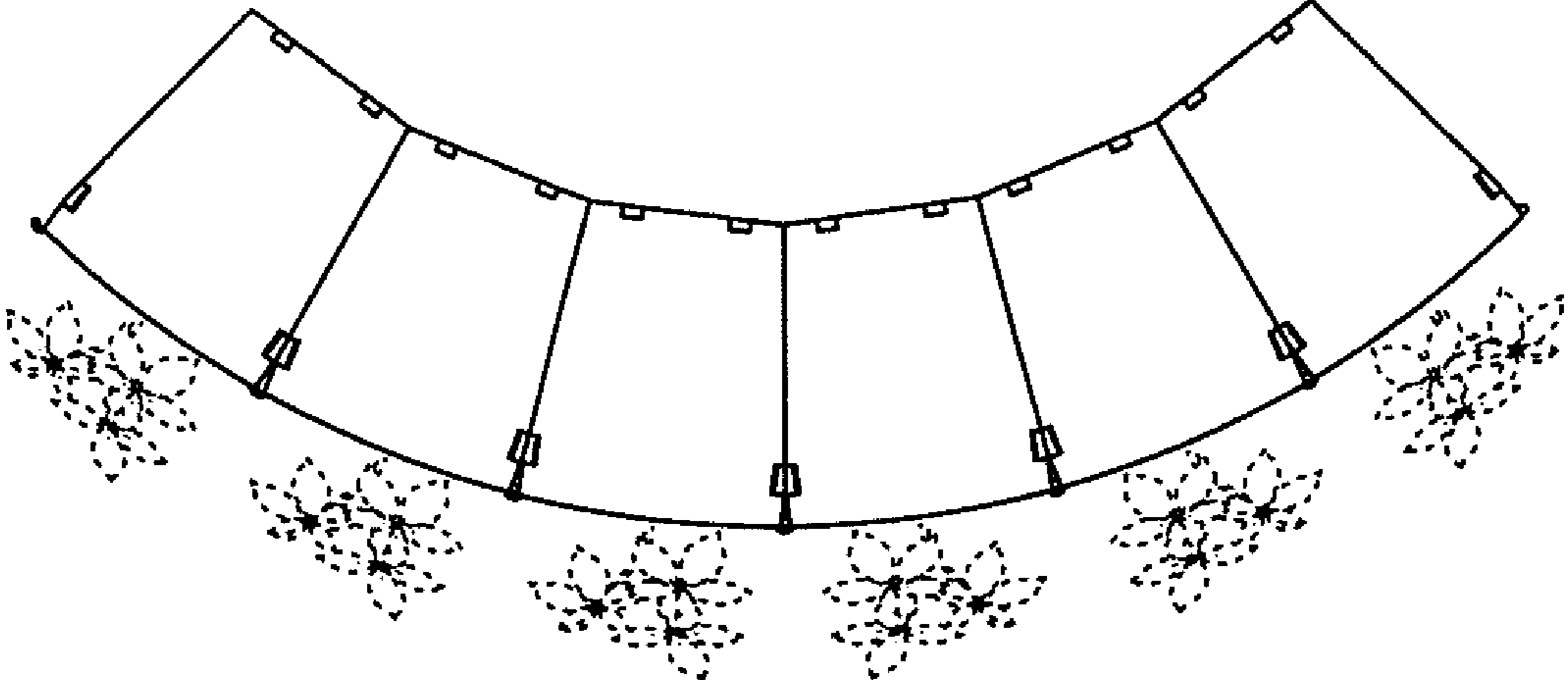
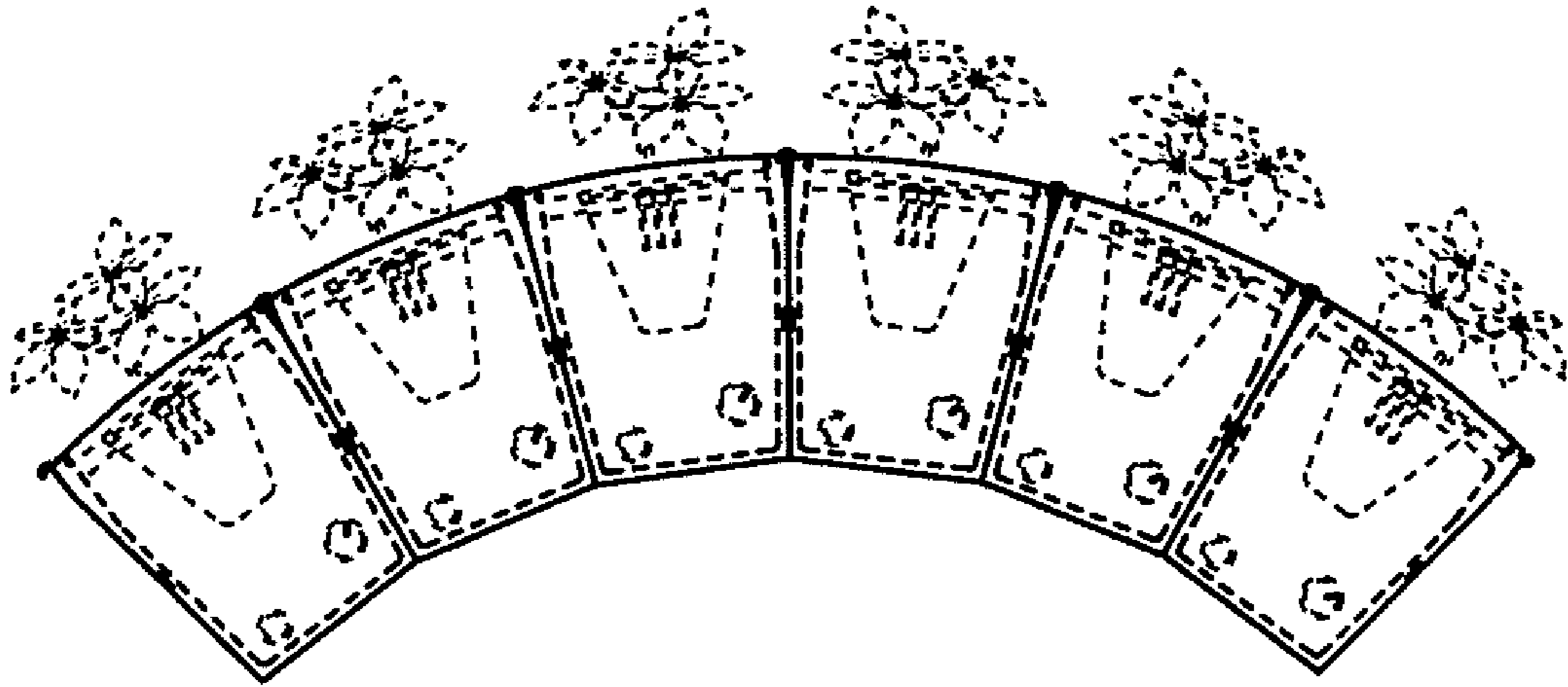

Fig. 6



F i g . 7

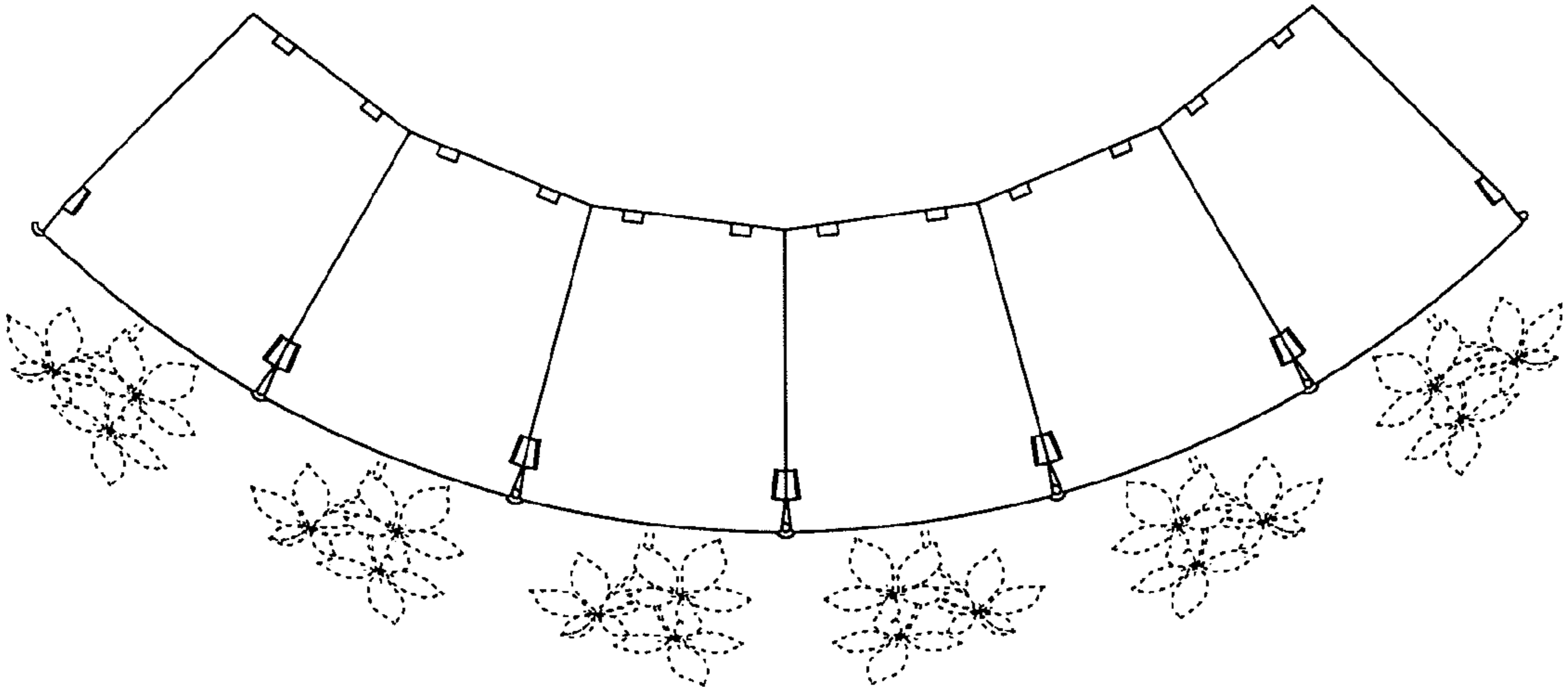

Fig. 8

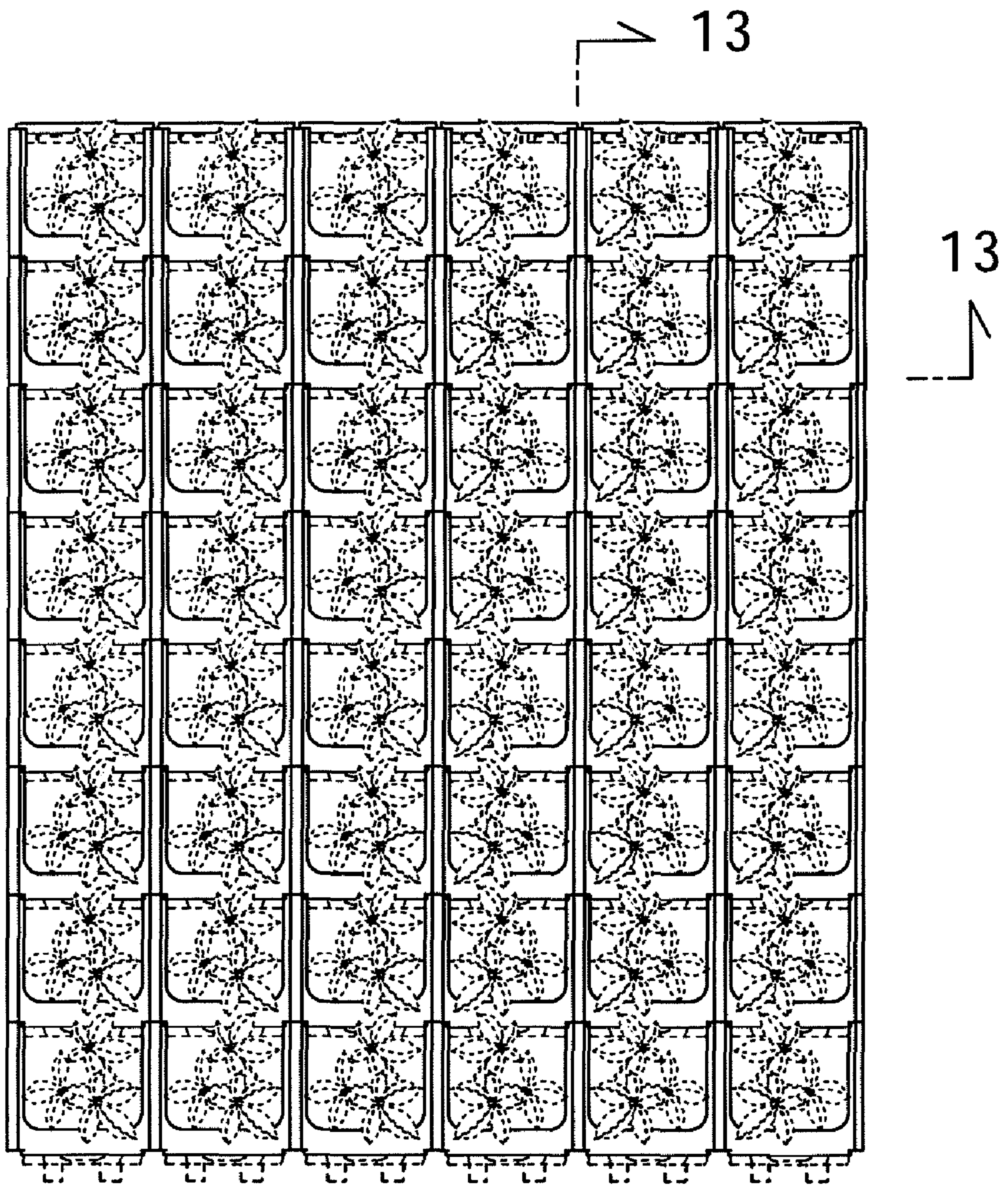
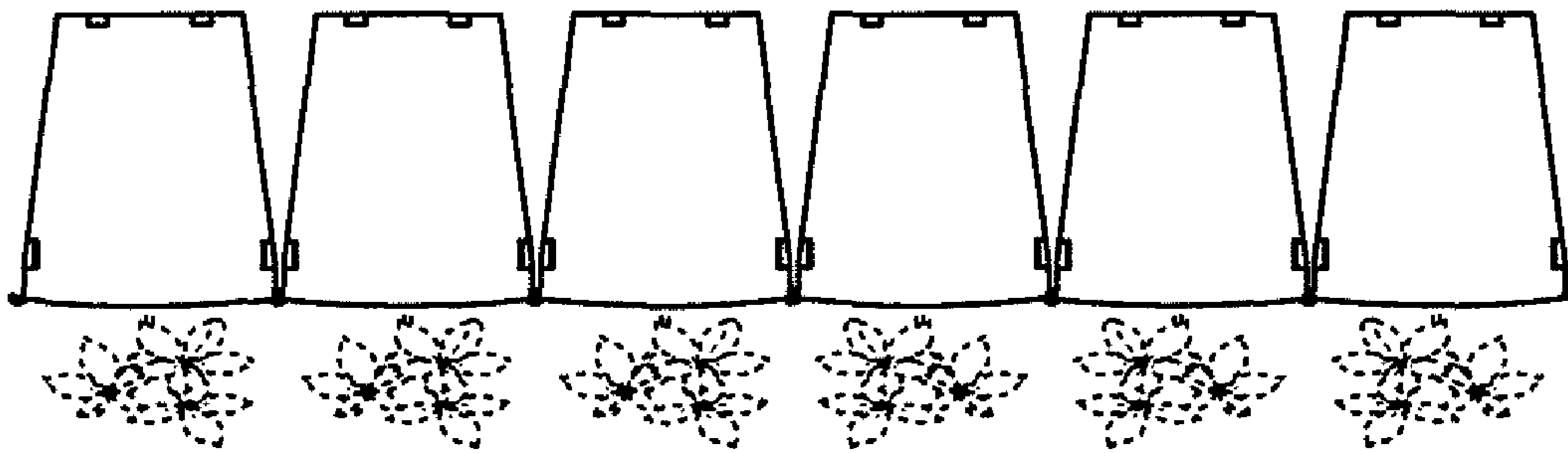

Fig. 9



F i g . 1 0

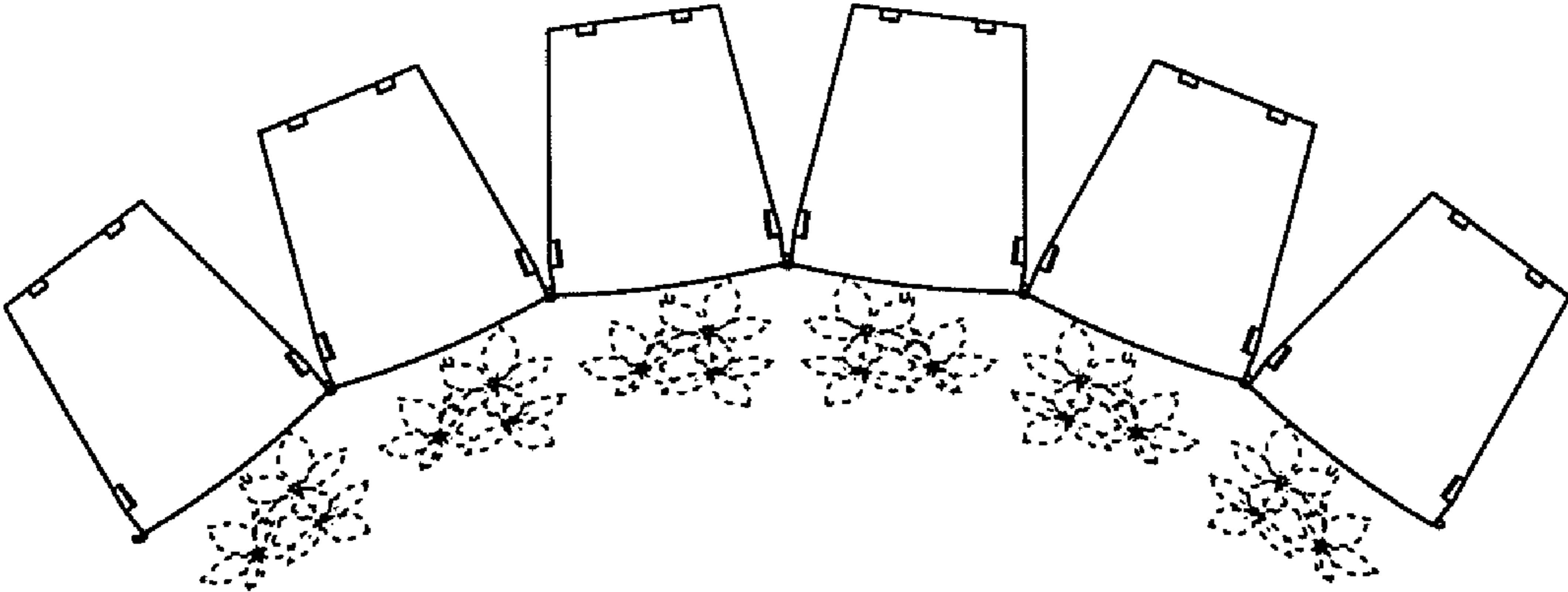

Fig. 11

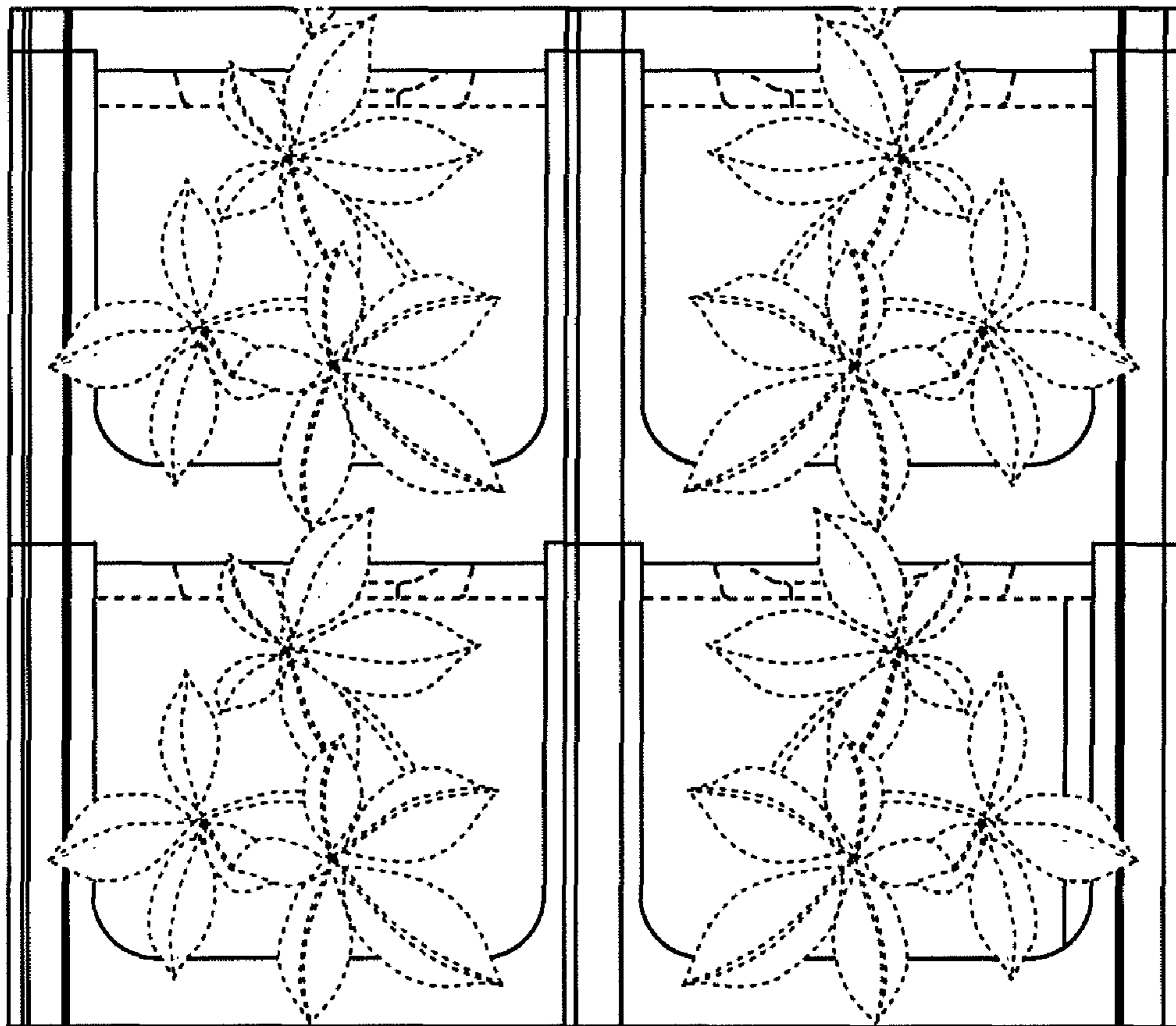

Fig. 12

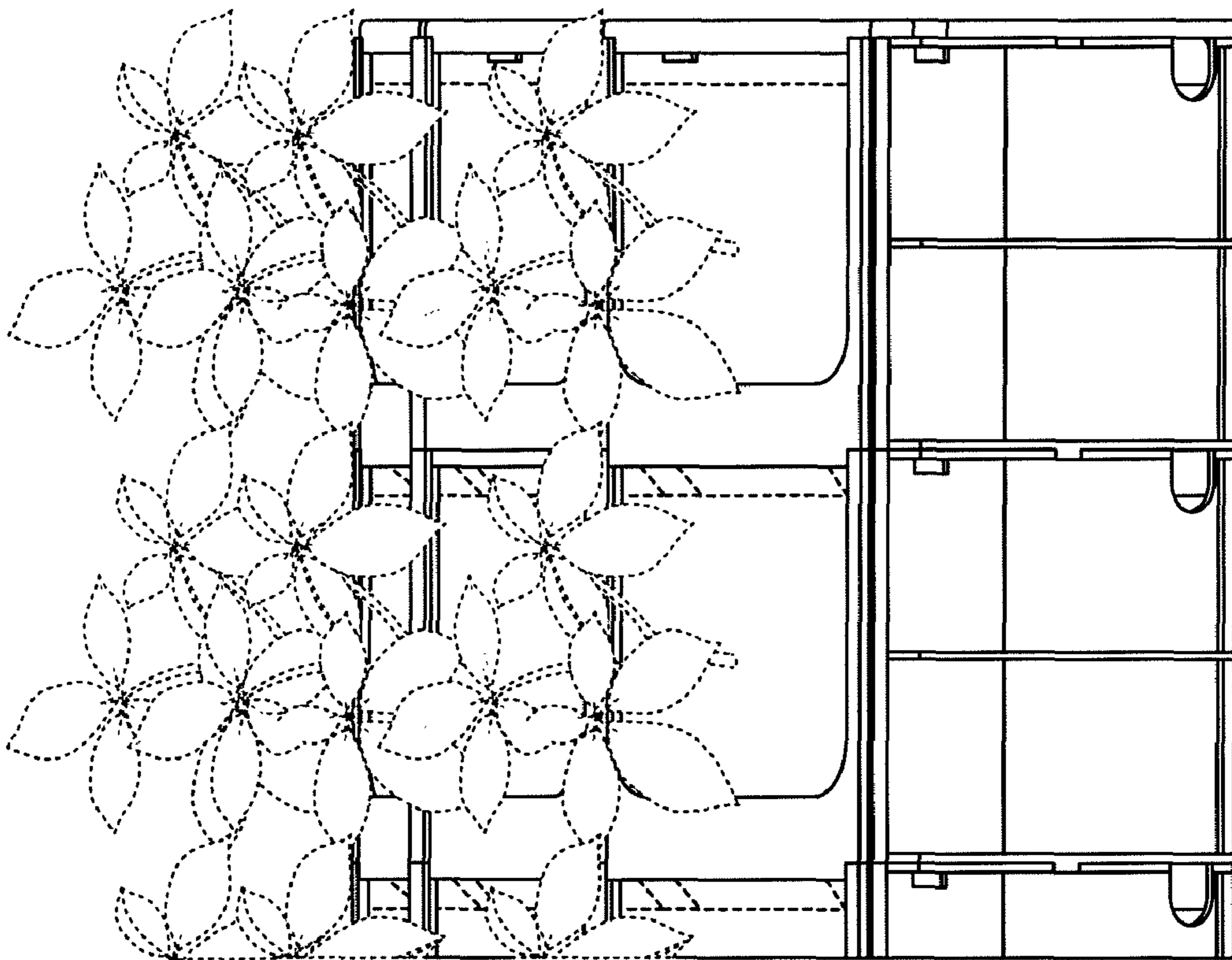

Fig. 13

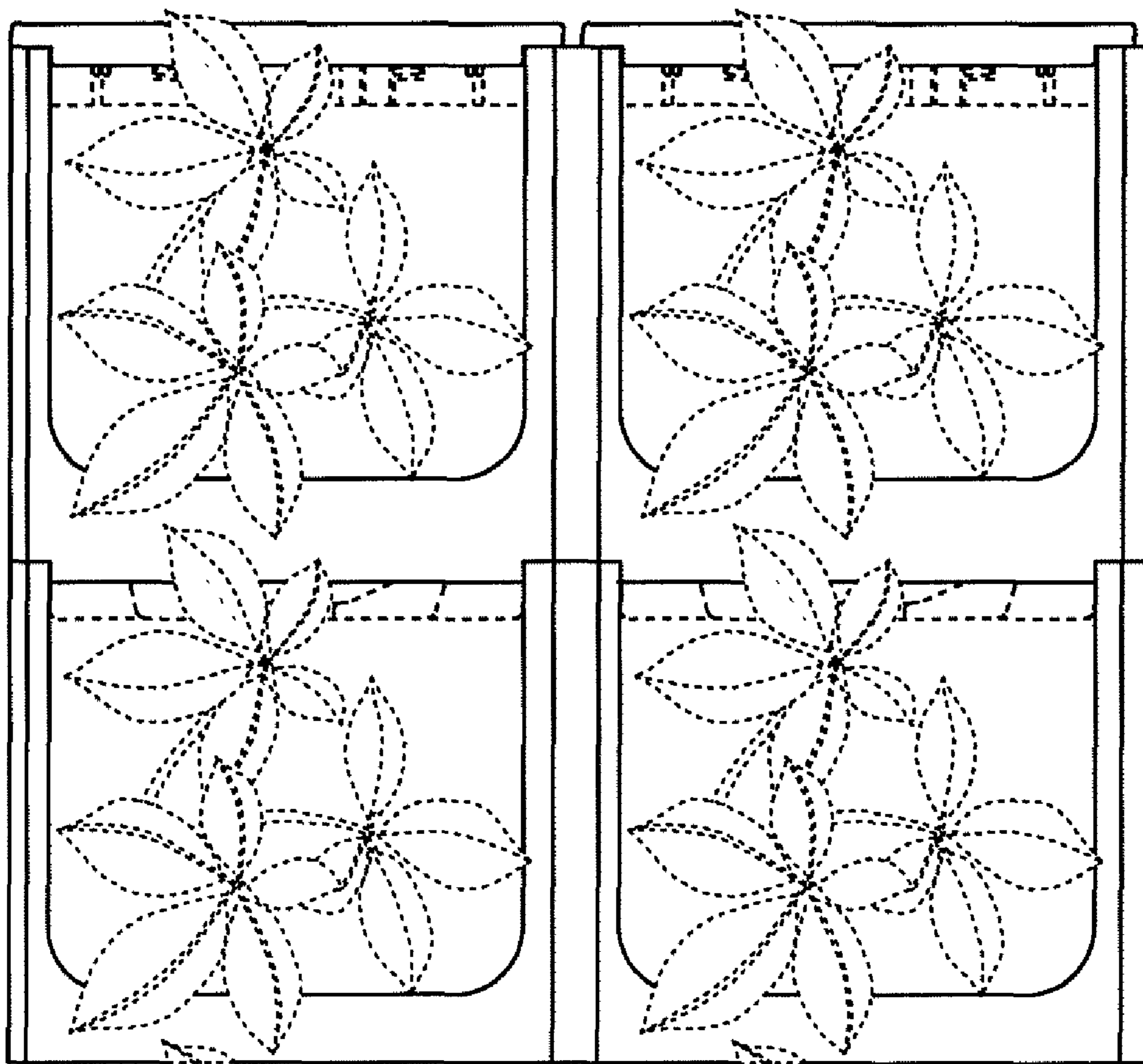

Fig. 14

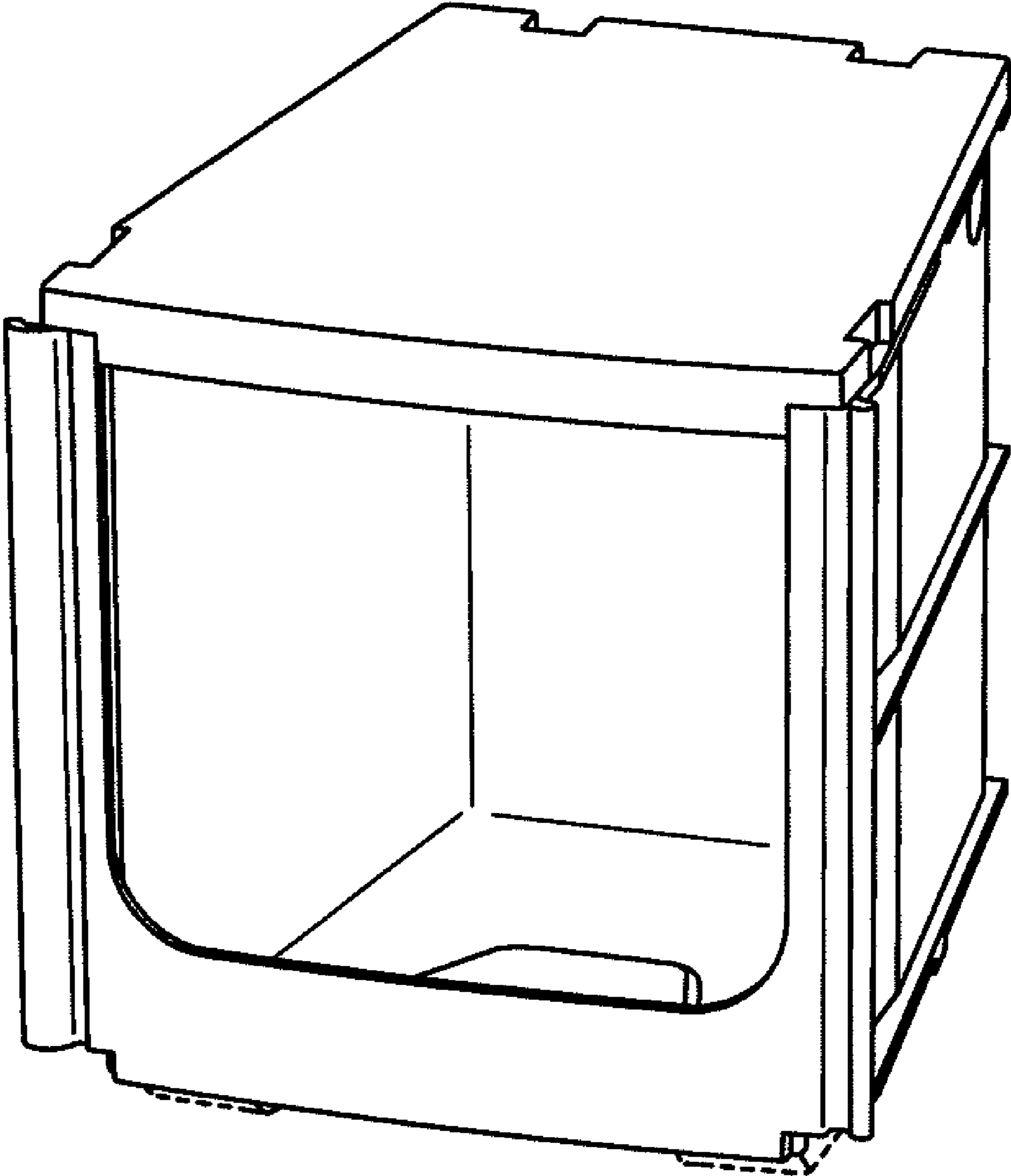

Fig. 15

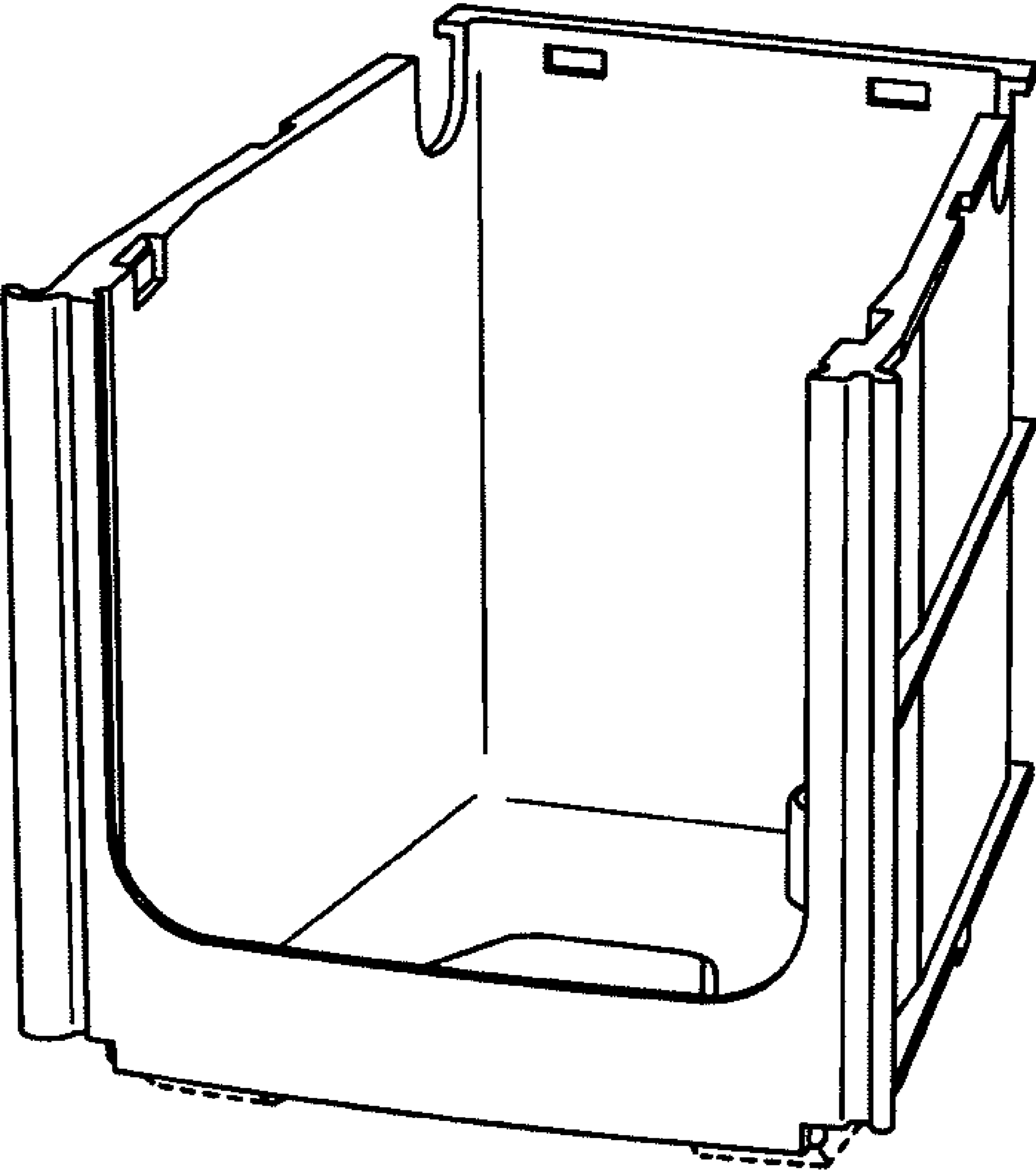

Fig. 16

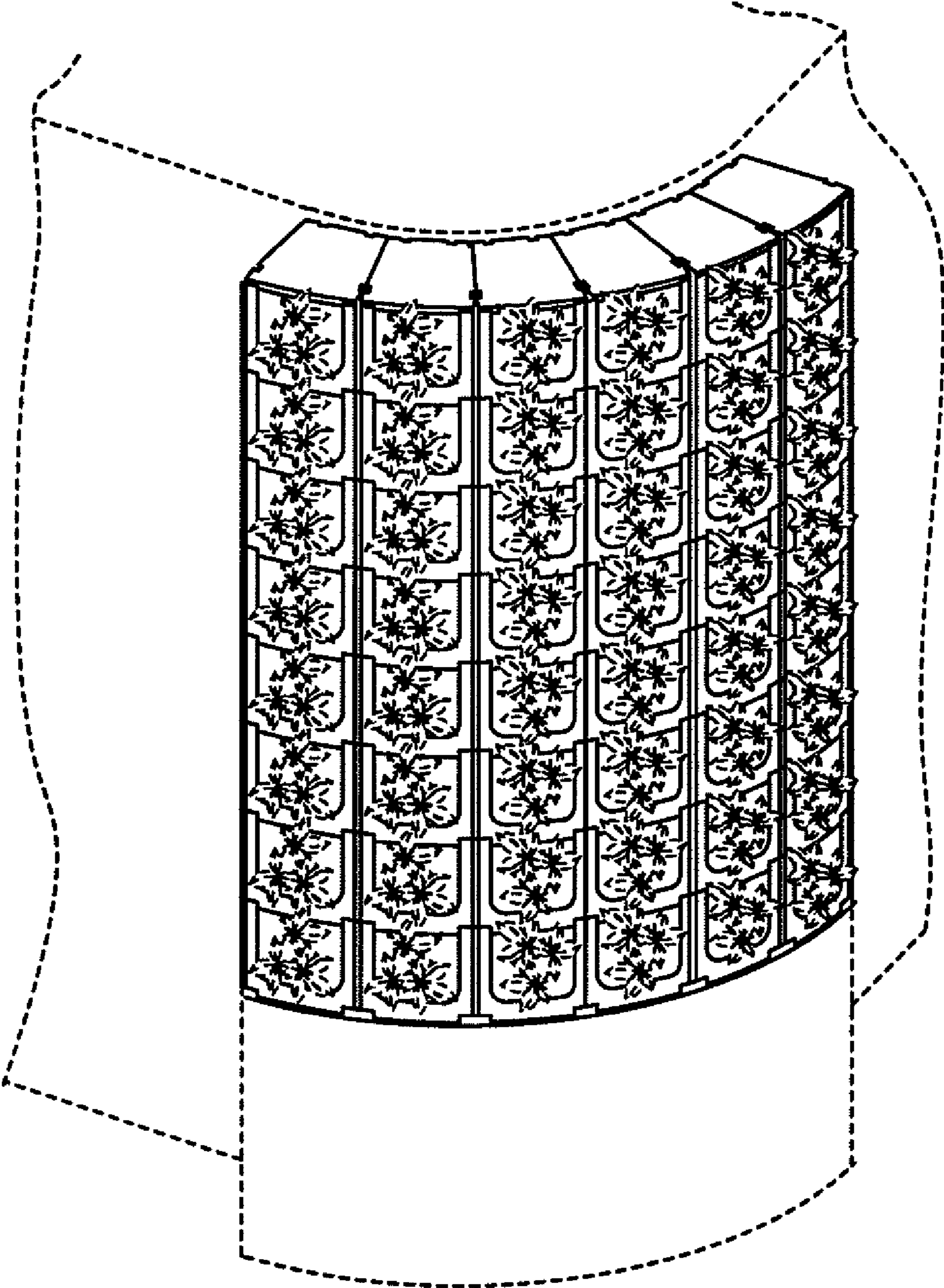

Fig. 17

