



US00D651891S

(12) **United States Design Patent**  
**Bell**

(10) **Patent No.:** **US D651,891 S**  
(45) **Date of Patent:** **\*\* Jan. 10, 2012**

(54) **BED LINEN BOOK DESIGN PACKAGE**

(75) Inventor: **James Bell**, Glencoe, IL (US)

(73) Assignee: **Jab Distributors, LLC**, Wheeling, IL (US)

(\*\*) Term: **14 Years**

(21) Appl. No.: **29/378,389**

(22) Filed: **Nov. 3, 2010**

(51) **LOC (9) Cl.** ..... **09-03**

(52) **U.S. Cl.** ..... **D9/421**

(58) **Field of Classification Search** ..... D9/430-433,  
D9/414-418, 420-429, 560, 737, 756; D3/273,  
D3/302; 206/421, 454, 457, 775-778, 784,  
206/822; 220/500, 523-529, 552, 555; 229/100,  
229/103.3, 104-106, 108, 108.1, 109, 110,  
229/111, 112, 117.09, 117.12, 117.15, 120,  
229/125.015, 160.1, 162.1, 182.1, 215, 247,  
229/406, 407, 902, 920, 922, 930, 942, 67.3,  
229/67.4, 68.1; D19/2, 26

See application file for complete search history.

(56) **References Cited**

**U.S. PATENT DOCUMENTS**

1,525,321	A *	2/1925	Pike	217/5
2,061,992	A *	11/1936	Wilson	229/116.1
2,155,203	A *	4/1939	Polacsek	206/103
D175,722	S *	10/1955	Graham	D9/634
2,874,707	A *	2/1959	Koppel	132/315
3,087,605	A *	4/1963	Kester	206/459.5
3,315,718	A *	4/1967	Berman	220/837

3,583,729	A *	6/1971	De Groot	281/31
4,892,195	A *	1/1990	Slavin et al.	206/473
7,036,665	B1 *	5/2006	Gyr	206/472
D575,150	S *	8/2008	Hageman	D9/432
2004/0245137	A1 *	12/2004	Gelardi	206/472

\* cited by examiner

*Primary Examiner* — Thomas Johannes

(74) *Attorney, Agent, or Firm* — McAndrews, Held & Malloy, Ltd.

(57) **CLAIM**

The ornamental design for a bed linen book design package, as shown and described.

**DESCRIPTION**

FIG. 1 is a perspective view of a bed linen book design package showing my new design in a closed condition; FIG. 2 is a top plan view thereof; FIG. 3 is a front elevation view thereof; FIG. 4 is a right end elevation view thereof; FIG. 5 is a back elevation view thereof; FIG. 6 is a left end elevation view thereof; FIG. 7 is a bottom plan view thereof; FIG. 8 is a top plan view thereof in an open condition, the bottom plan view being a mirror image thereto; FIG. 9 is a front elevation thereof; FIG. 10 is a left side elevation view thereof; FIG. 11 is a right side elevation view thereof; and, FIG. 12 is a back elevation view thereof.

The lightweight, dot-dash broken line portion of the figure drawings is included to show unclaimed subject matter (surface indicia, text, illustrations, and packaged bed linen) only and forms no part of the claimed design; whereas, the heavy-weight, dash-dash lines show claimed stitching.

**1 Claim, 6 Drawing Sheets**



FIG.1



FIG.2

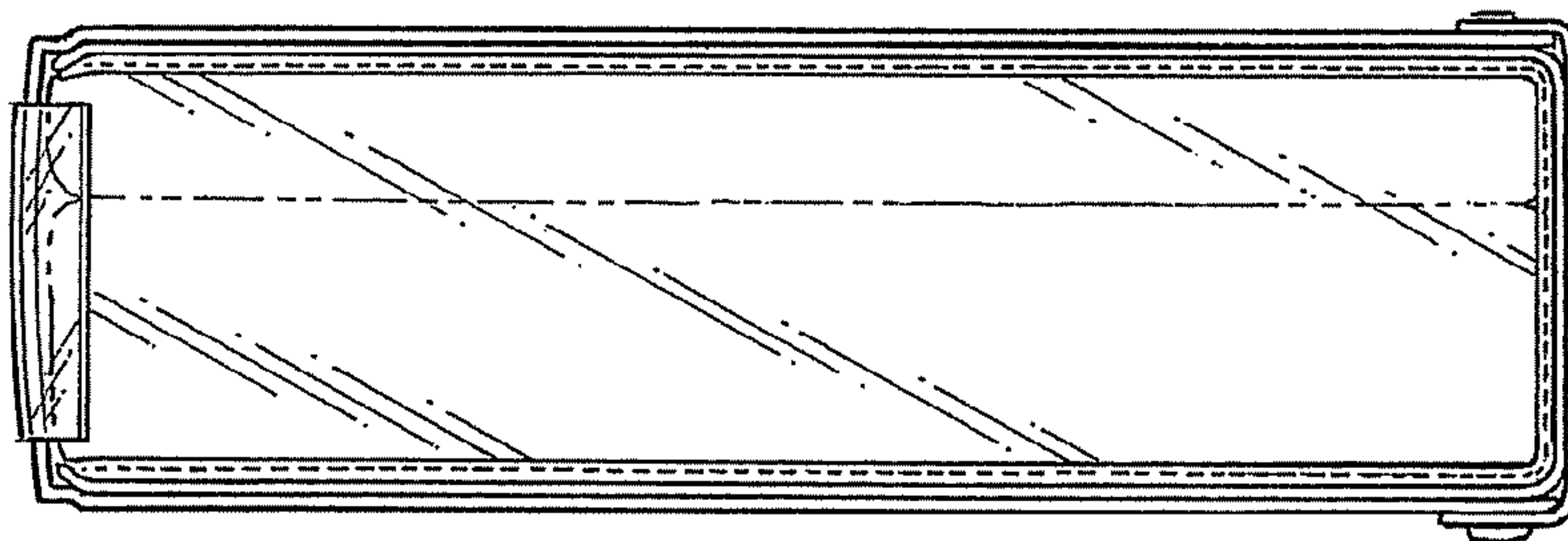



FIG.3

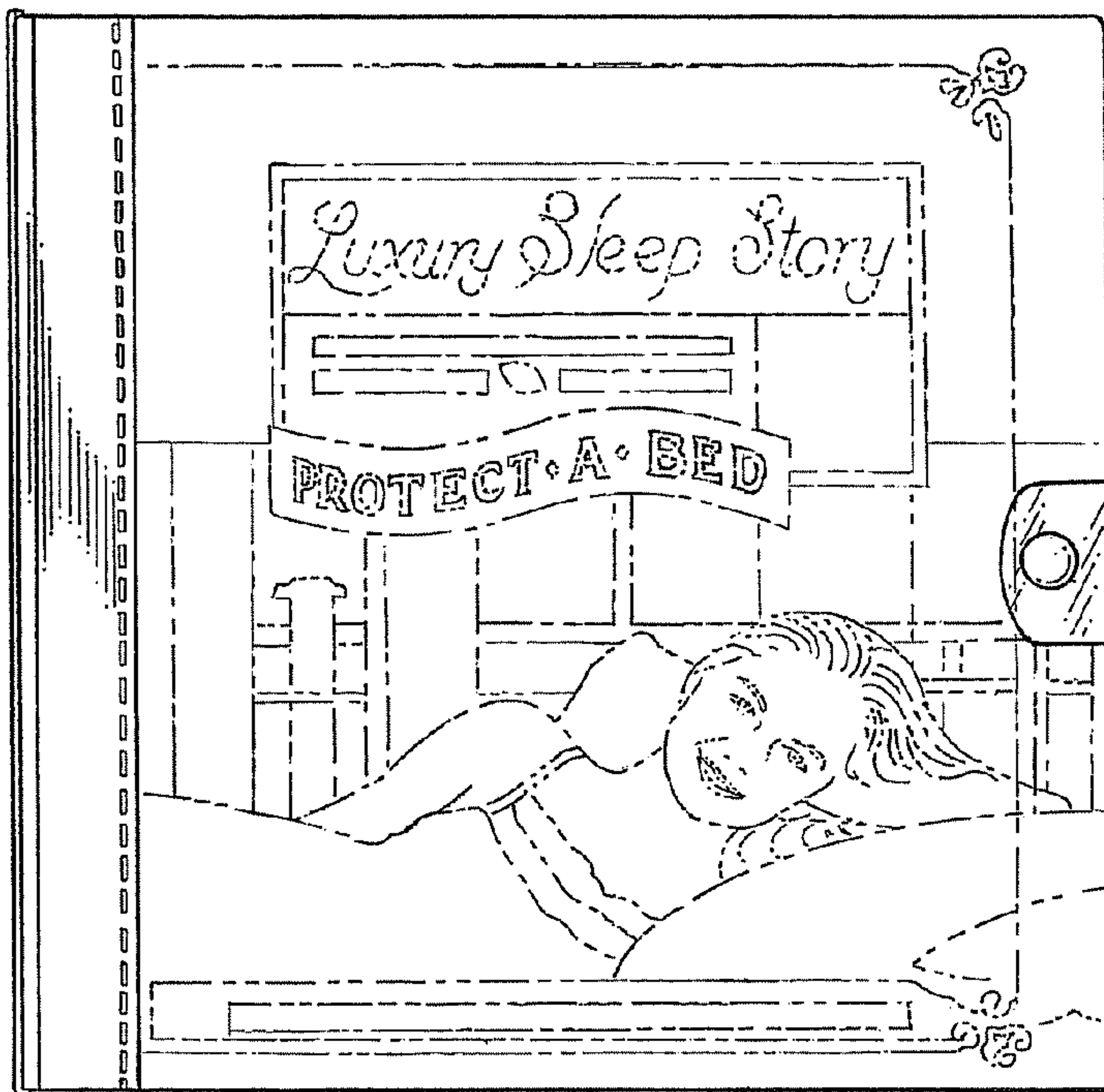

FIG.4

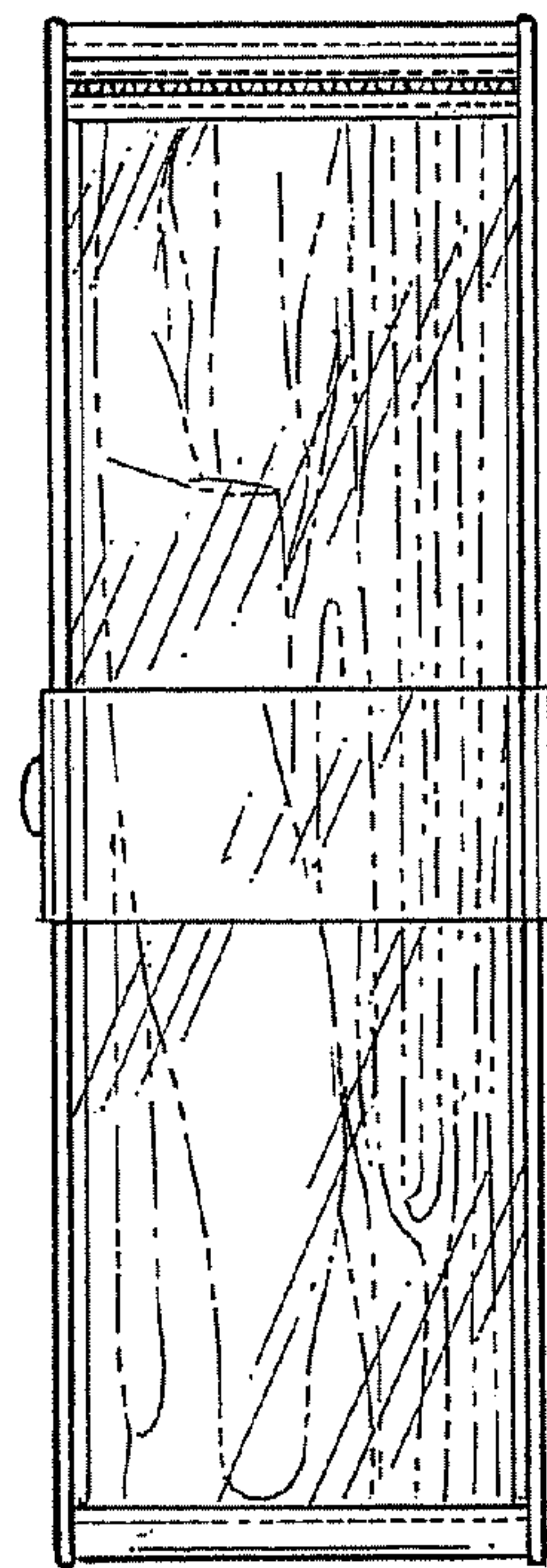

FIG.5

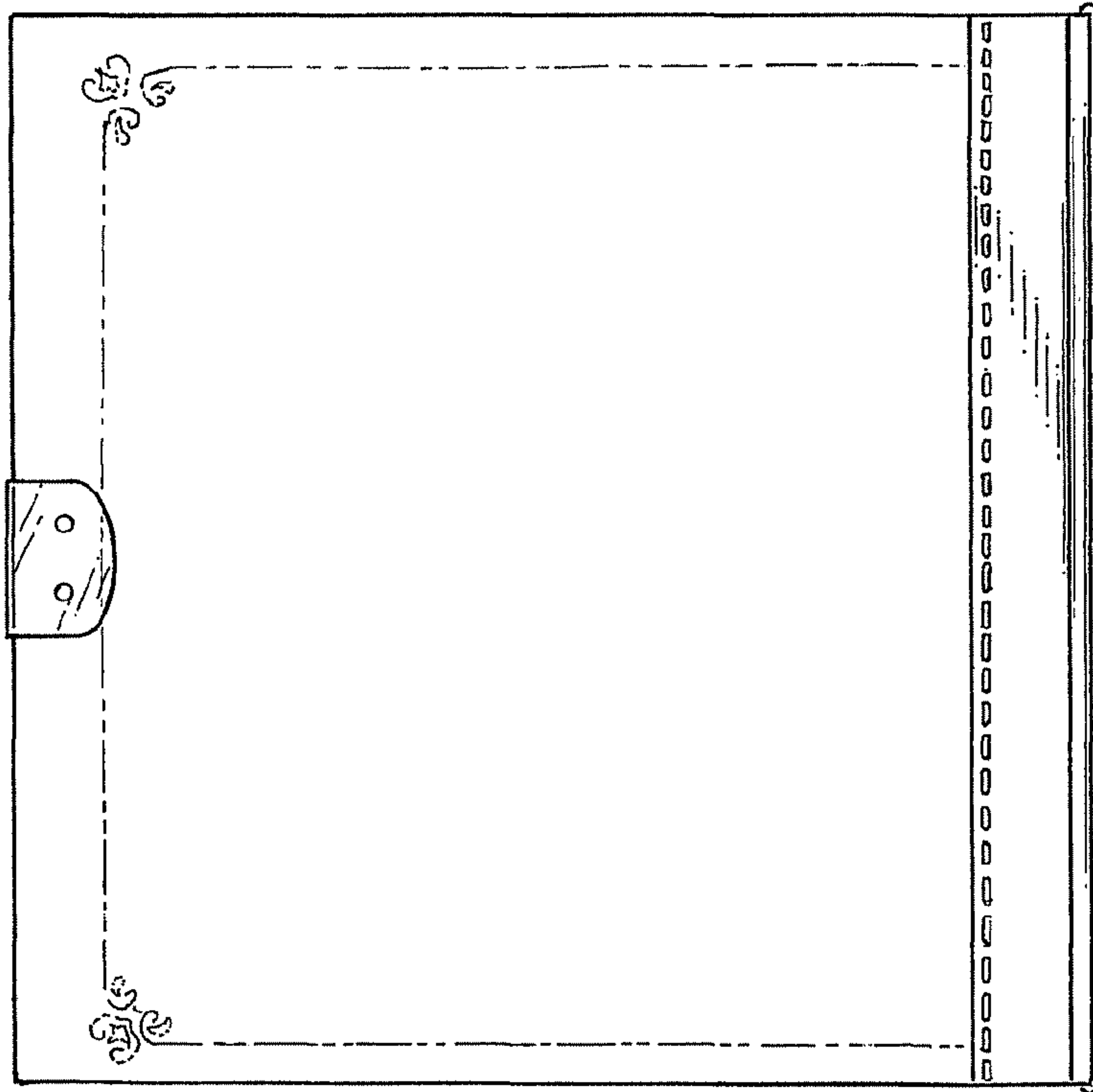

FIG.6

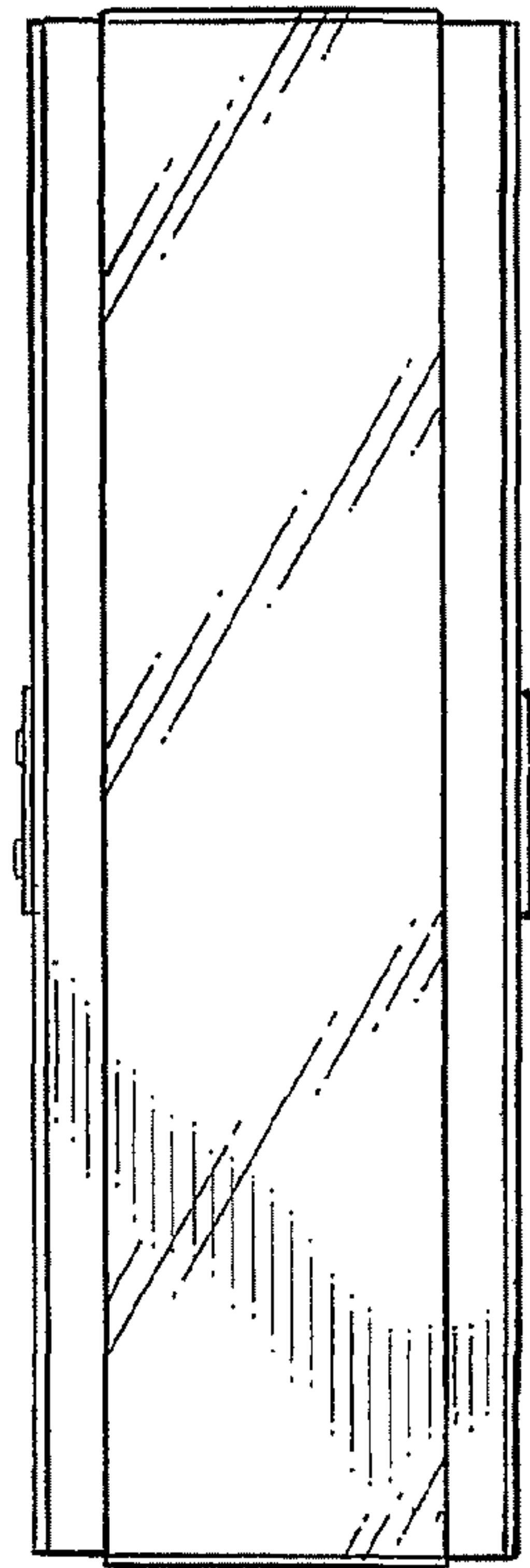
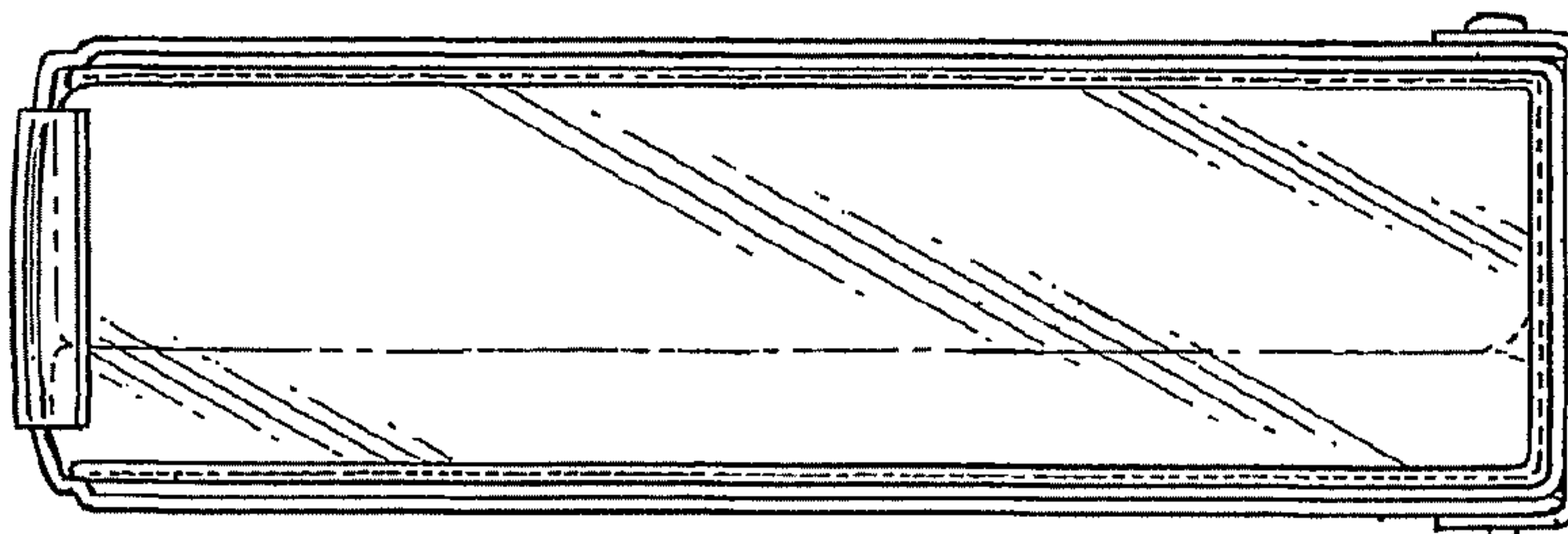

FIG.7



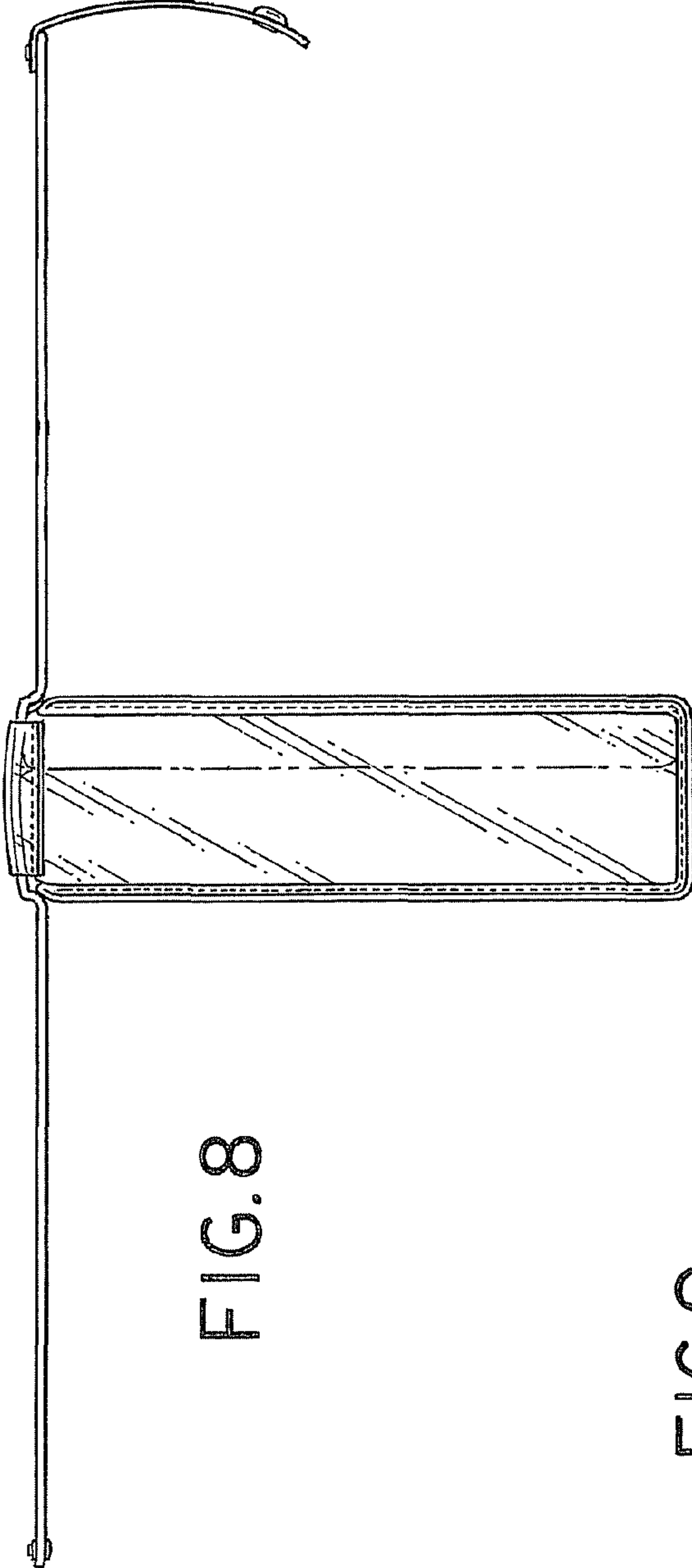

FIG. 8

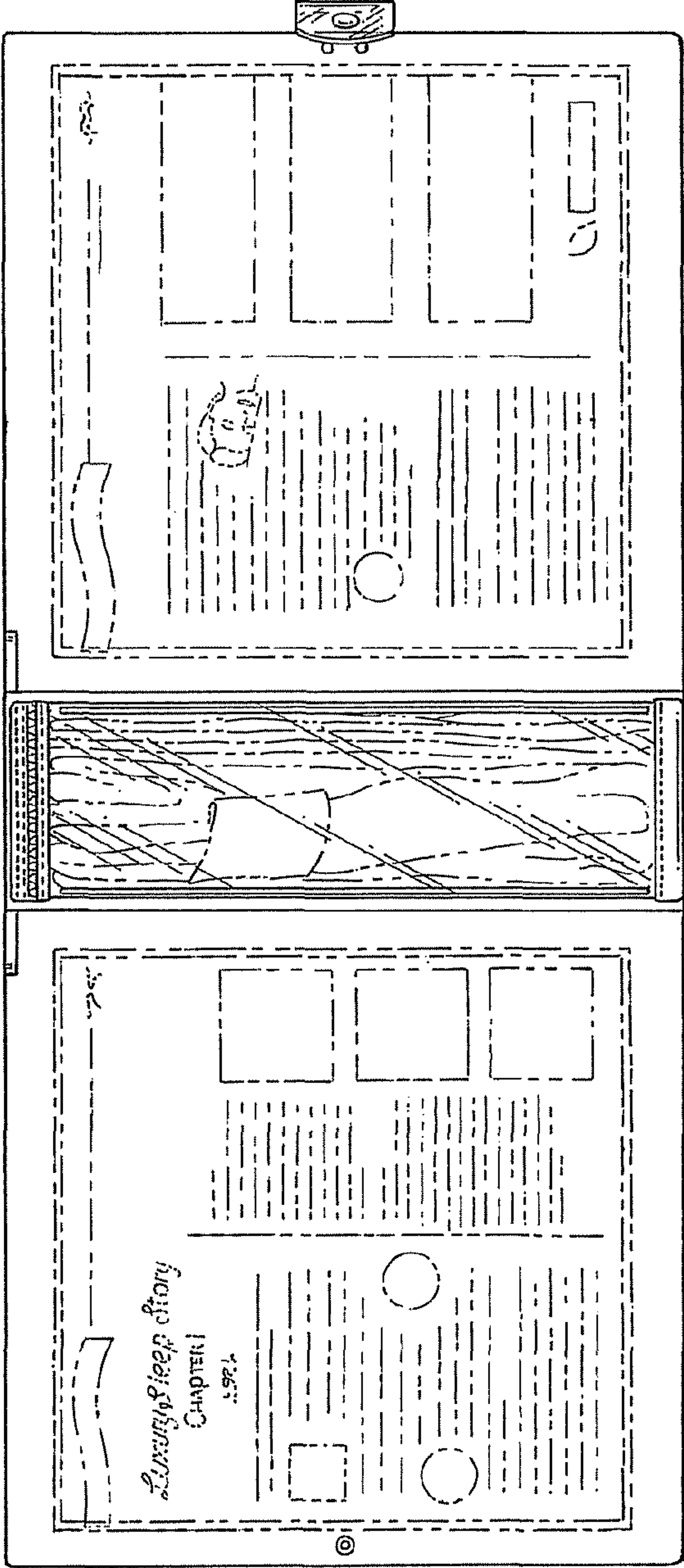

FIG. 9

FIG.10

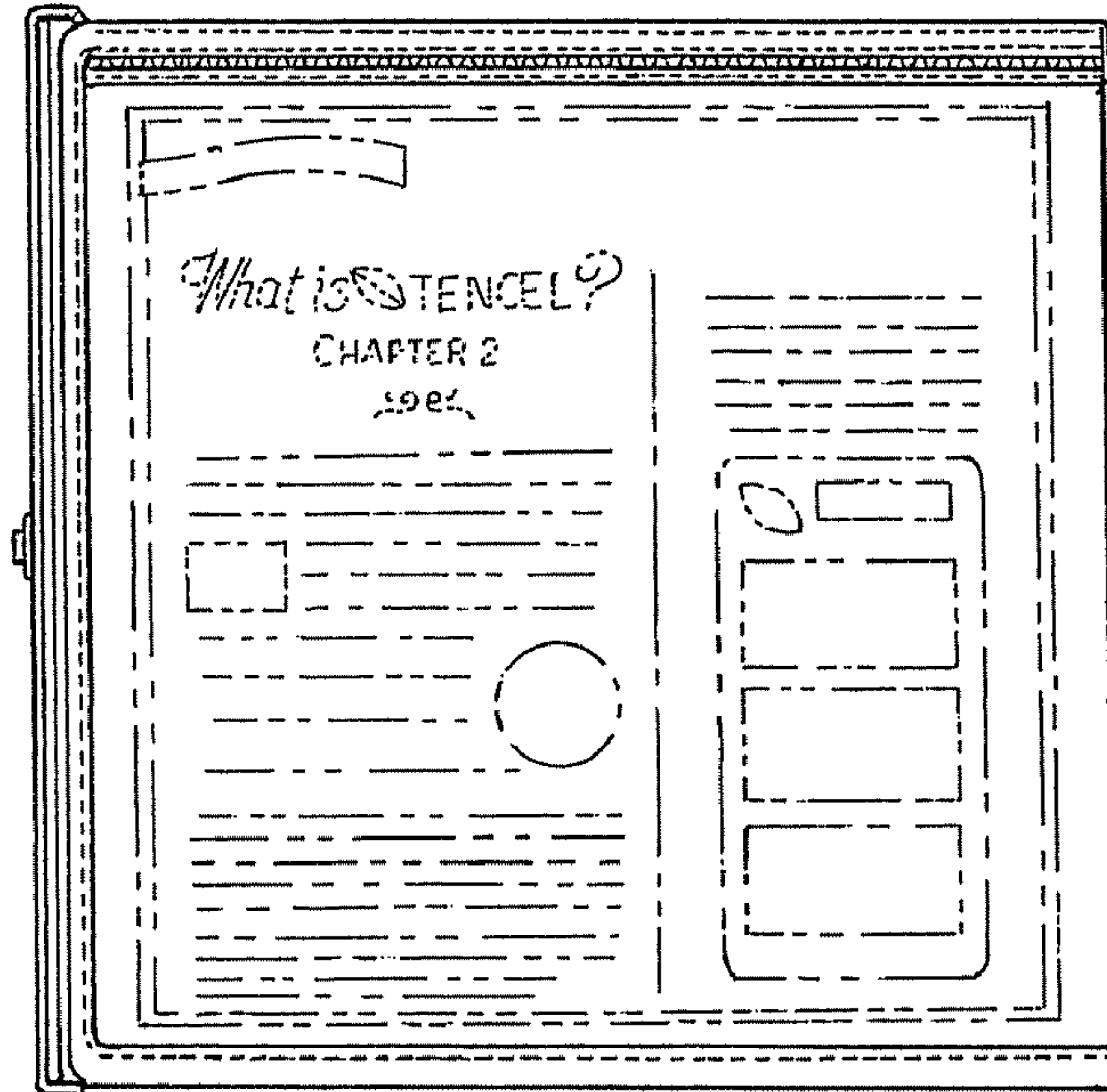
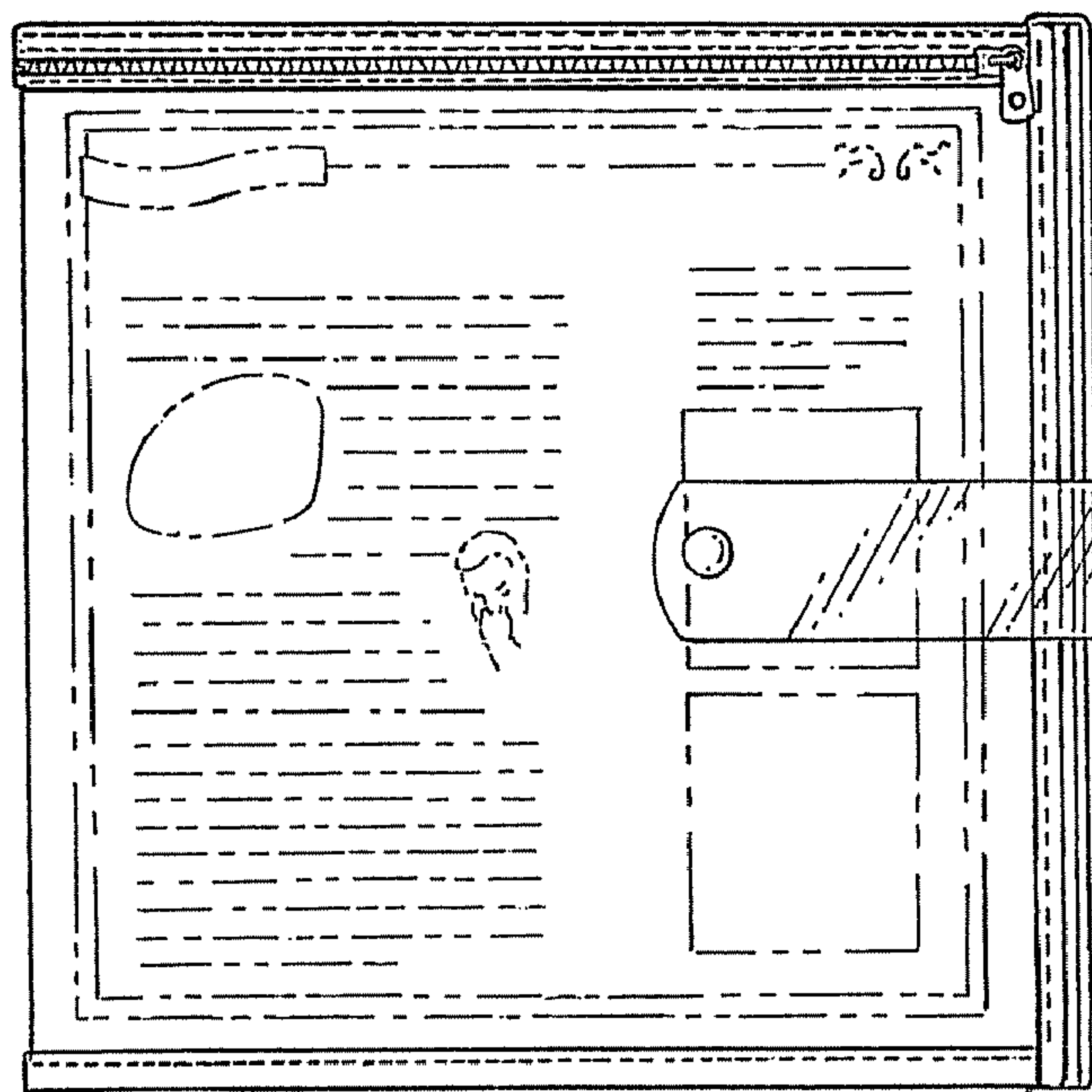

FIG.11





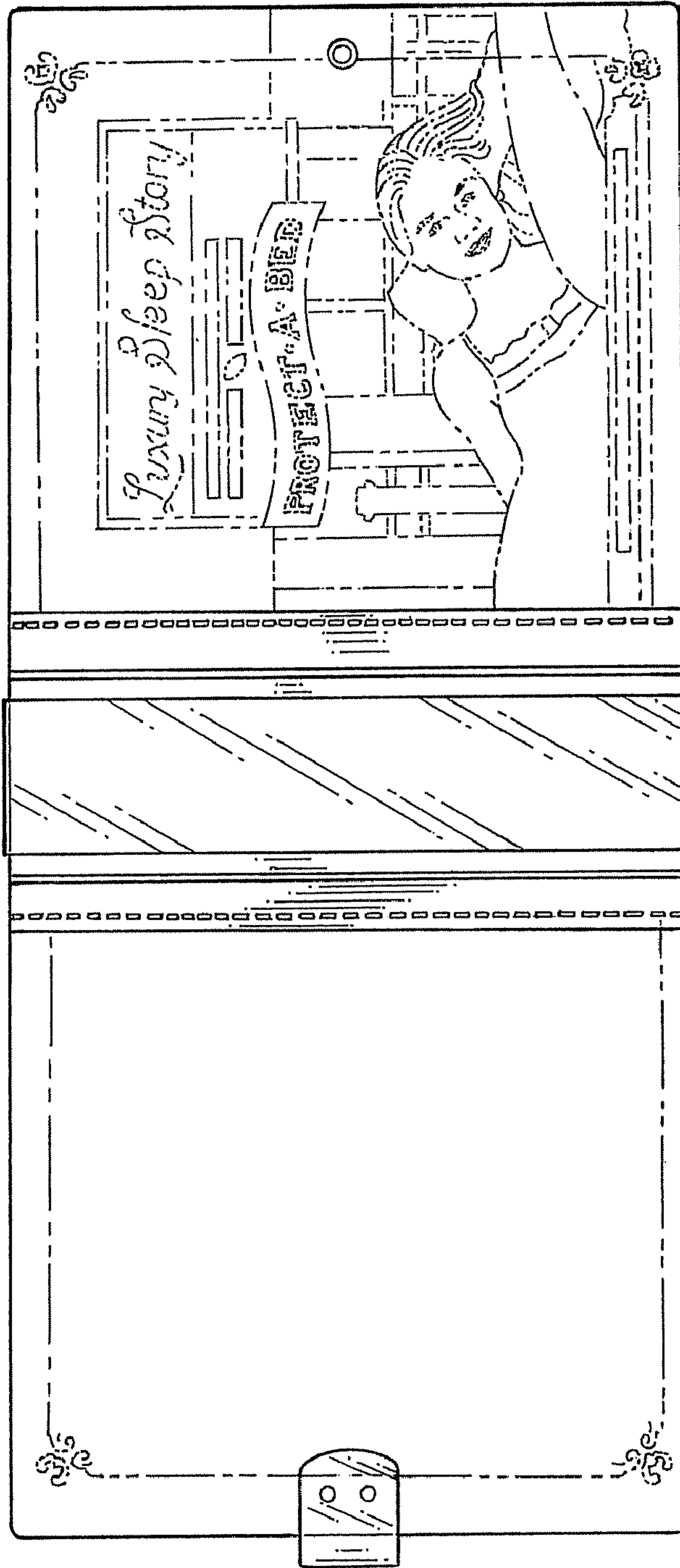

FIG.12