



US00D651862S

(12) **United States Design Patent**
Fontana-Kwon

(10) **Patent No.:** **US D651,862 S**
(45) **Date of Patent:** **** Jan. 10, 2012**

(54) **BOTTLE COVER**

(76) Inventor: **Martha Fontana-Kwon**, Kaneohe, HI
(US)

(**) Term: **14 Years**

(21) Appl. No.: **29/366,165**

(22) Filed: **Jul. 20, 2010**

(51) **LOC (9) Cl.** **07-06**

(52) **U.S. Cl.** **D7/625**

(58) **Field of Classification Search** D7/538,
D7/539, 514, 544, 571, 601, 602, 619.1, 619.2,
D7/625, 622, 623, 624.1, 624.2, 710, 628,
D7/634, 391; D2/700, 724, 725, 726, 727,
D2/720, 627, 823, 828, 835, 838, 840, 841,
D2/843; 2/85, 86, 87, 88, 93, 96, 108; 215/390,
215/395, 400; 220/592.16, 592.17, 592.2,
220/592.24, 23.91, 62.11, 62.12, 737, 739;
D9/631

See application file for complete search history.

(56) **References Cited**

U.S. PATENT DOCUMENTS

665,942	A	*	1/1901	Tabler	383/74
2,021,714	A	*	11/1935	Cole	2/115
D168,246	S	*	11/1952	Wilson	D2/724
D173,259	S	*	10/1954	Cohen	D2/725
3,349,409	A	*	10/1967	Hall	2/74
3,369,256	A	*	2/1968	Kern	2/114
D211,565	S	*	7/1968	Crump	D7/624.2
4,867,214	A	*	9/1989	Fuller	428/35.8
D333,593	S	*	3/1993	Edison et al.	D7/625
D334,889	S	*	4/1993	Condemi	
D368,000	S	*	3/1996	Mazza et al.	D7/625
D379,303	S	*	5/1997	Broye	
D403,209	S	*	12/1998	Zigterman	
D421,366	S	*	3/2000	Mogil	D7/625
D422,459	S	*	4/2000	Webb	
D426,113	S	*	6/2000	Webb et al.	D7/625
D480,609	S	*	10/2003	Hicks et al.	D7/625
D481,267	S	*	10/2003	Yamane	D7/625
D482,242	S	*	11/2003	Yamane	D7/625
D482,243	S	*	11/2003	Yamane	D7/625
D482,244	S	*	11/2003	Yamane	D7/625

D482,935	S	*	12/2003	Yamane	D7/625
D484,366	S	*	12/2003	Yamane	D7/625
D489,229	S	*	5/2004	Yamane	D7/625
D489,576	S	*	5/2004	Ramsdale	D7/606
D493,676	S	*	8/2004	Cohen et al.	D7/625
D494,423	S	*	8/2004	Wright	D7/606
D497,780	S	*	11/2004	Hicks et al.	D7/624.2
D499,309	S	*	12/2004	Hicks	D7/625
D501,119	S	*	1/2005	Mazza	D7/625
D504,051	S	*	4/2005	Hanson	D7/625
D504,800	S	*	5/2005	Garcia	
D505,049	S	*	5/2005	Ramsdale	D7/606
D505,838	S	*	6/2005	Hicks	D7/625
D514,394	S	*	2/2006	McWilliams	D7/625
D516,387	S	*	3/2006	Zacharias et al.	D7/625
D517,798	S	*	3/2006	Lown et al.	D3/202
D517,868	S	*	3/2006	Hong	D7/604
7,467,729	B2	*	12/2008	Lown et al.	220/739
D604,995	S	*	12/2009	Cepero	
D605,903	S	*	12/2009	Battle	
D614,451	S	*	4/2010	Jensen	

* cited by examiner

Primary Examiner — Elizabeth J Oswecki

(74) *Attorney, Agent, or Firm* — QuickPatents, Inc.; Kevin Prince

(57) **CLAIM**

What is claimed is the ornamental design for a bottle cover, as shown and described.

DESCRIPTION

FIG. 1 is a perspective view of a bottle cover, showing the new design;
FIG. 2 is a front elevational view thereof;
FIG. 3 is a rear elevational view thereof;
FIG. 4 is a right-side elevational view thereof;
FIG. 5 is a left-side elevational view thereof;
FIG. 6 is a top plan view thereof; and,
FIG. 7 is a bottom plan view thereof.
In the drawings, the broken lines of a bottle in FIGS. 1-6 depict environmental structure that forms no part of the claim. The broken lines on the cover in FIGS. 1-7 represent top stitching.

1 Claim, 5 Drawing Sheets

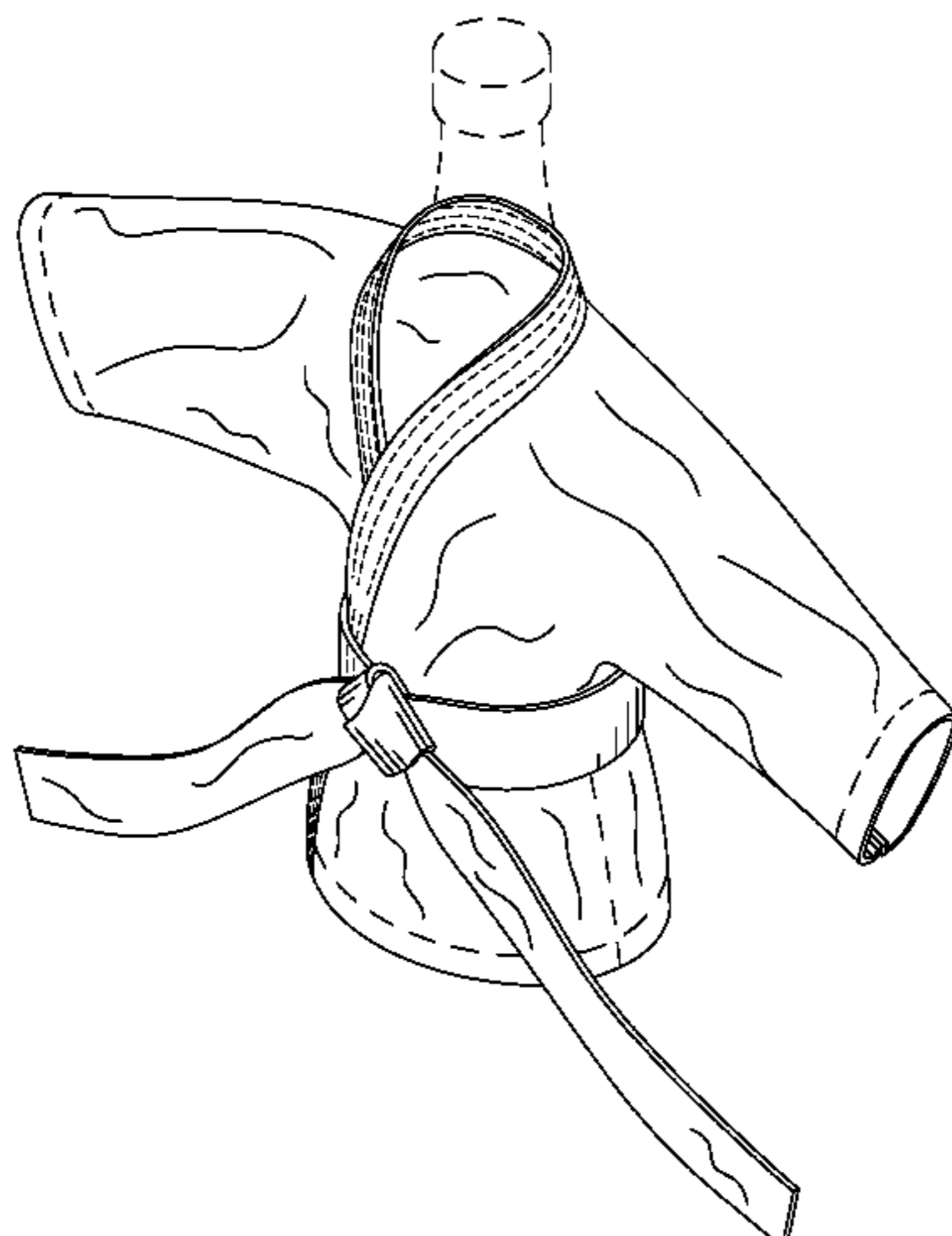

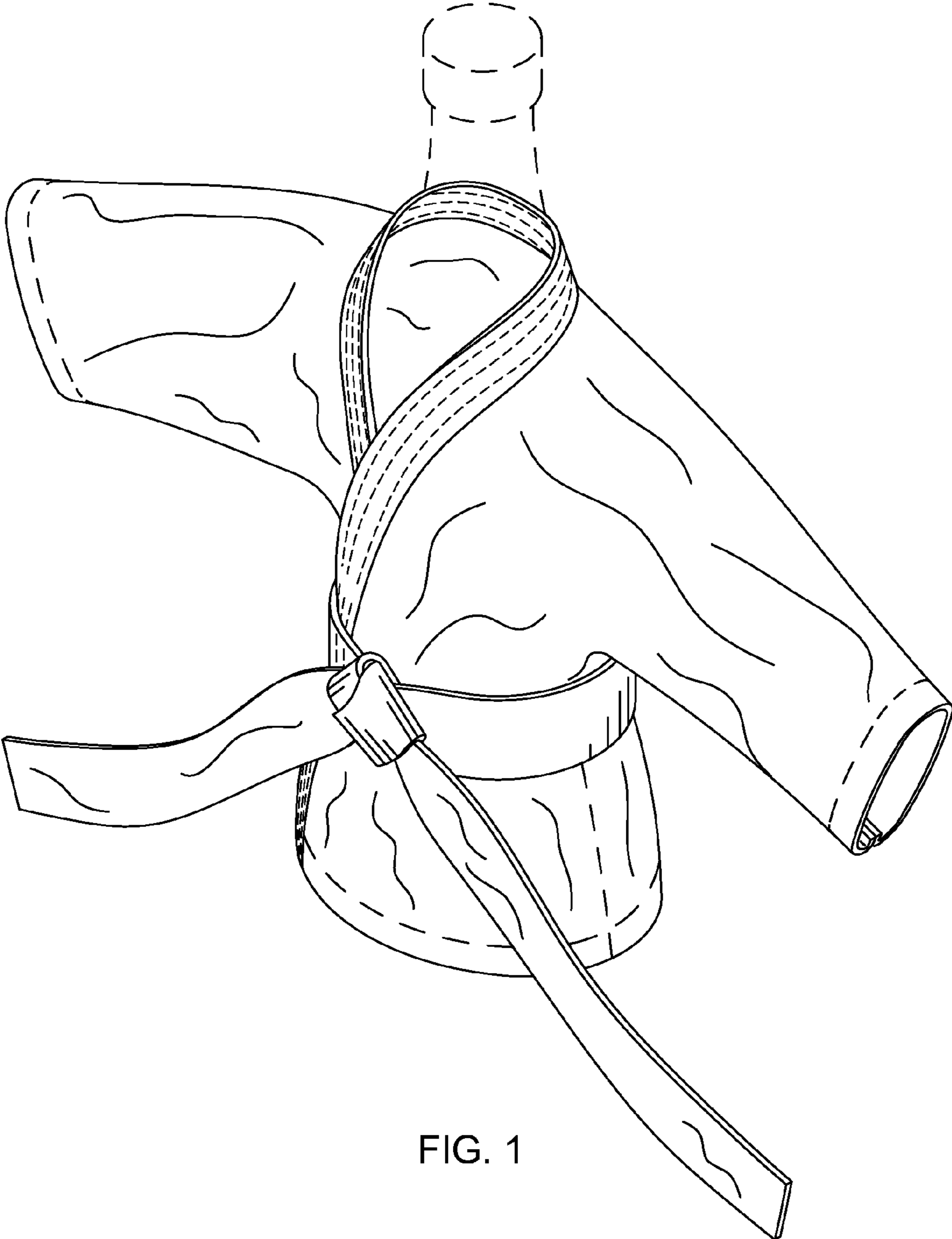

FIG. 1

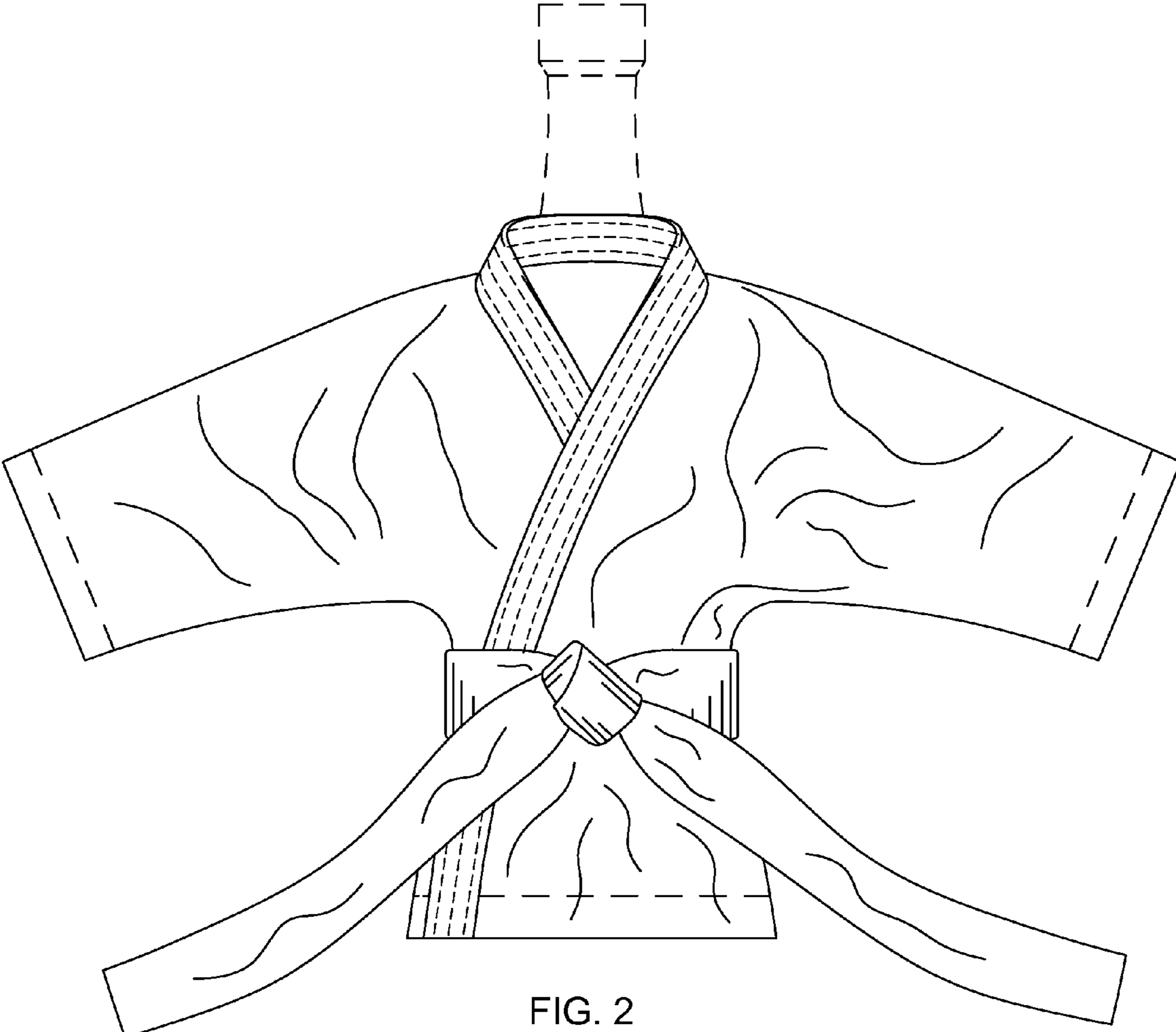
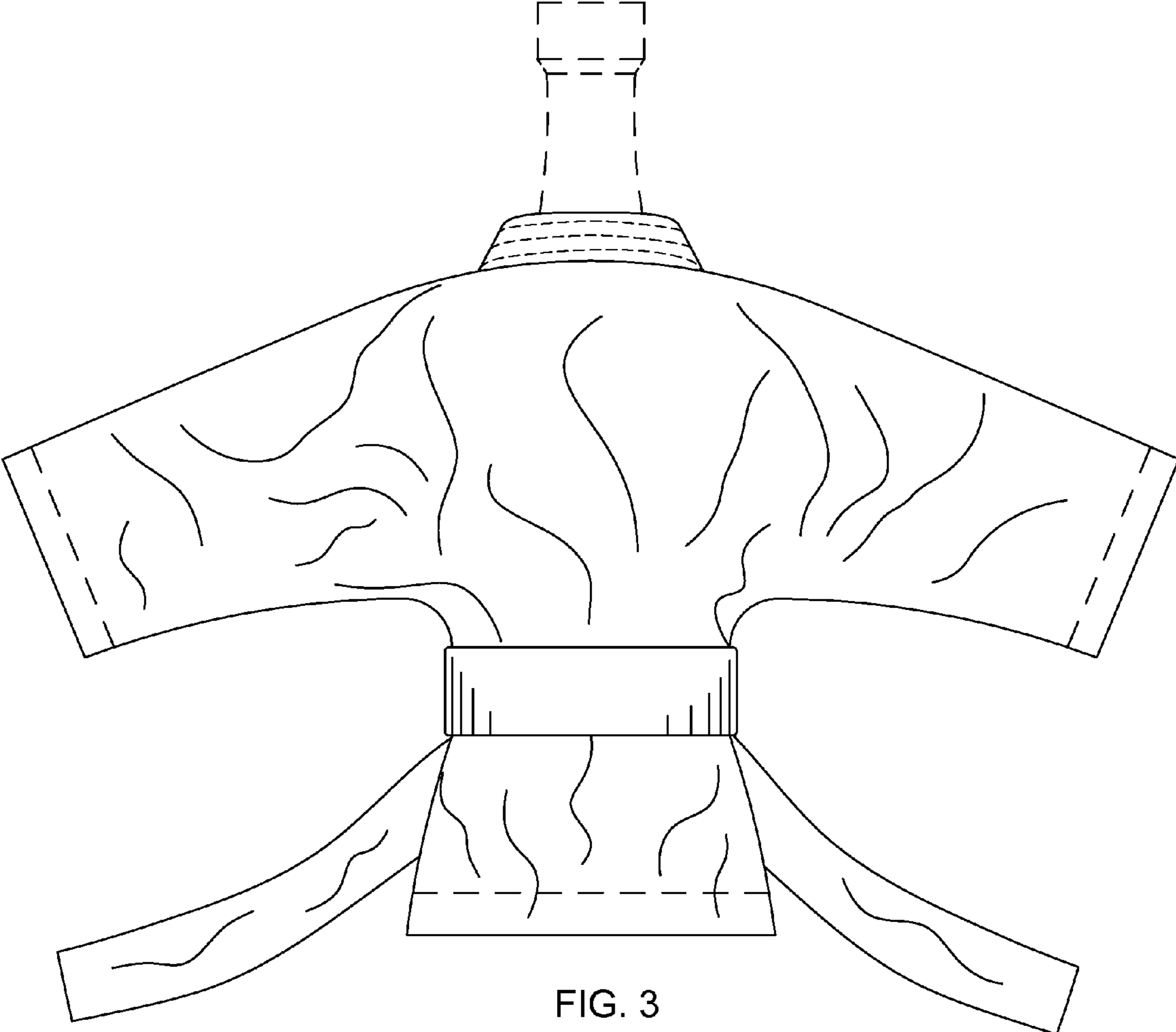

FIG. 2



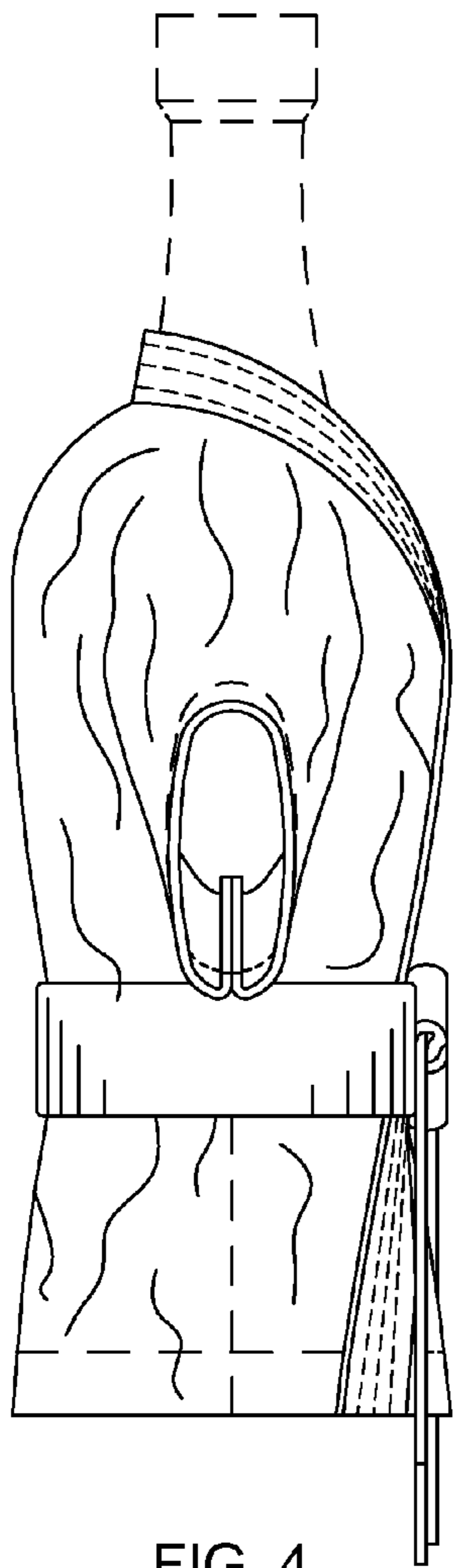

FIG. 4

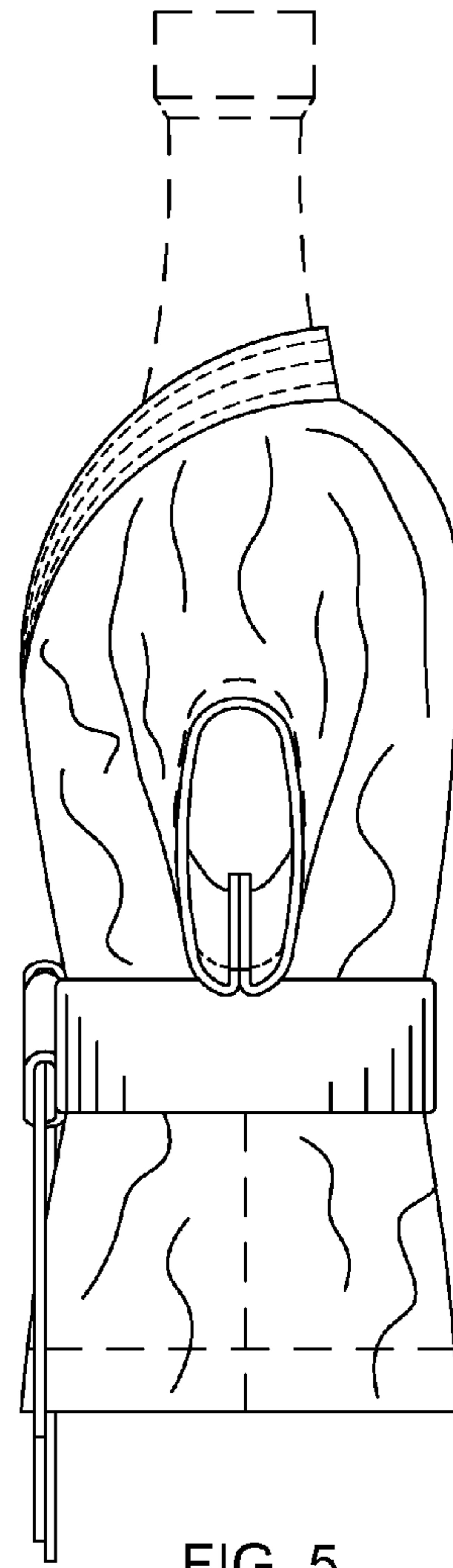

FIG. 5

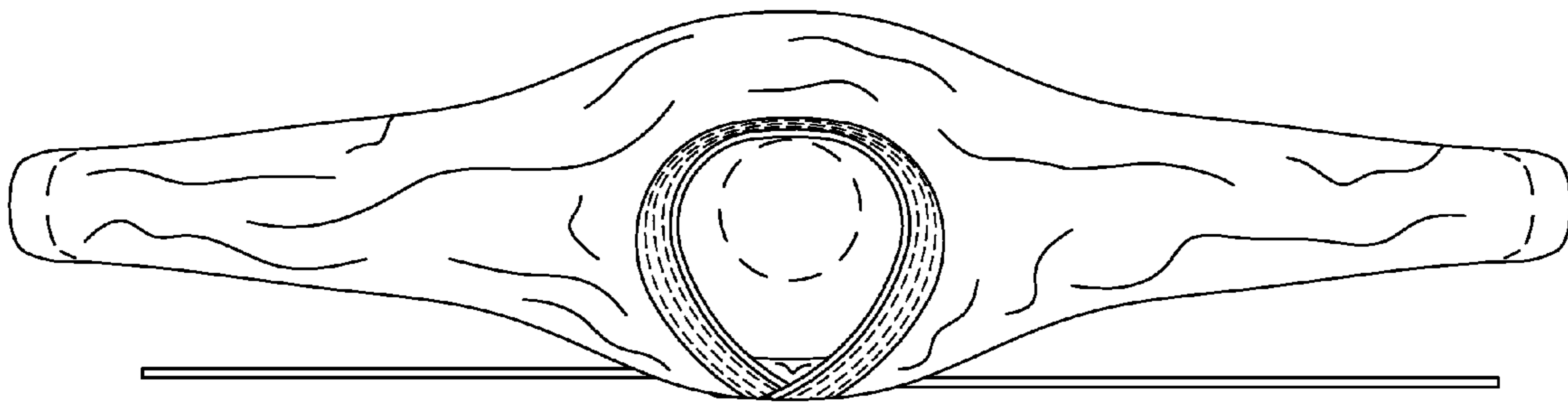

FIG. 6

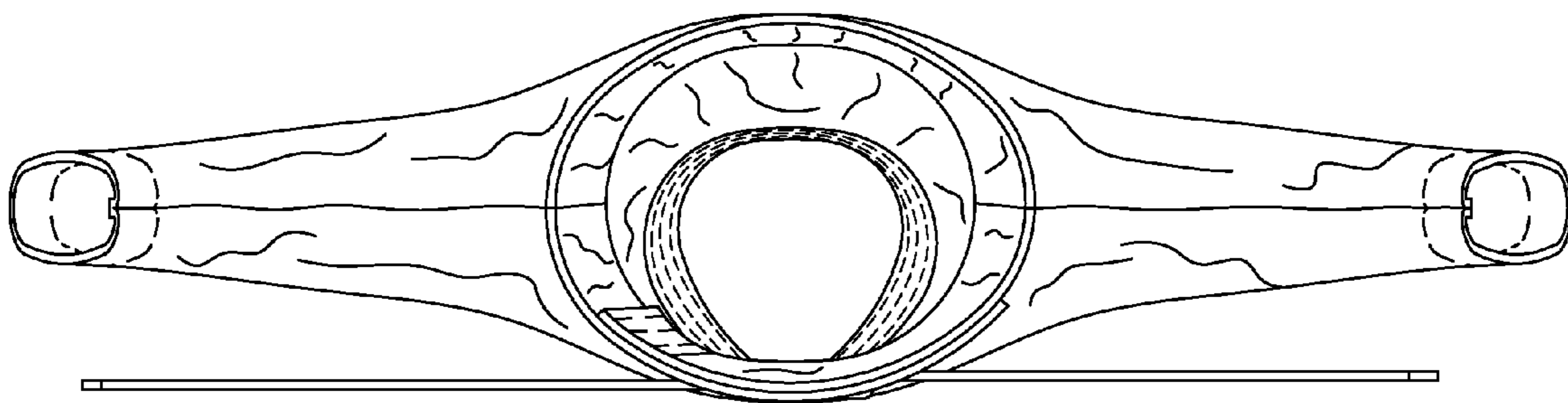

FIG. 7