



US00D651781S

(12) **United States Design Patent**
Geva et al.

(10) **Patent No.:** **US D651,781 S**

(45) **Date of Patent:** **** Jan. 3, 2012**

(54) **MODULAR SHOPPING CART**

(75) Inventors: **Rafi Geva**, Shoham (IL); **David Chiche**, Shoham (IL)

(73) Assignee: **Greencart Int Ltd.**, Airport City (IL)

(**) Term: **14 Years**

(21) Appl. No.: **29/381,908**

(22) Filed: **Dec. 26, 2010**

(30) **Foreign Application Priority Data**

Jun. 29, 2010 (IL) 49720

(51) **LOC (9) Cl.** **12-02**

(52) **U.S. Cl.** **D34/21**

(58) **Field of Classification Search** D34/12-27;
280/33.991, 33.992, 33.993, 33, 33.994,
280/47.35, 47.18, 47.24, 47.27

See application file for complete search history.

(56) **References Cited**

U.S. PATENT DOCUMENTS

D546,018 S * 7/2007 Goodell D34/21
D601,772 S * 10/2009 de Rueda et al. D34/12

D608,518 S * 1/2010 Luebke D34/21
2005/0121863 A1 * 6/2005 Libretti et al. 280/33.991
2009/0058025 A1 * 3/2009 Rolim De Oliveira .. 280/33.992
2010/0044982 A1 * 2/2010 Meiri 280/33.992

* cited by examiner

Primary Examiner — Cynthia Ramirez

(74) *Attorney, Agent, or Firm* — D. Kligler I.P. Services Ltd.

(57) **CLAIM**

The ornamental design for a modular shopping cart, as shown and described.

DESCRIPTION

FIG. 1 is an isometric view of the modular shopping cart, according to our new design;

FIG. 2 is a disassembled view of the modular shopping cart of FIG. 1;

FIG. 3 is a front view of the modular shopping cart of FIG. 1; FIG. 4 is a rear view of the modular shopping cart of FIG. 1; FIG. 5 is a left side view of the modular shopping cart of FIG. 1;

FIG. 6 is a right side view of the modular shopping cart of FIG. 1; and,

FIG. 7 is a top view of the modular shopping cart of FIG. 1.

1 Claim, 7 Drawing Sheets

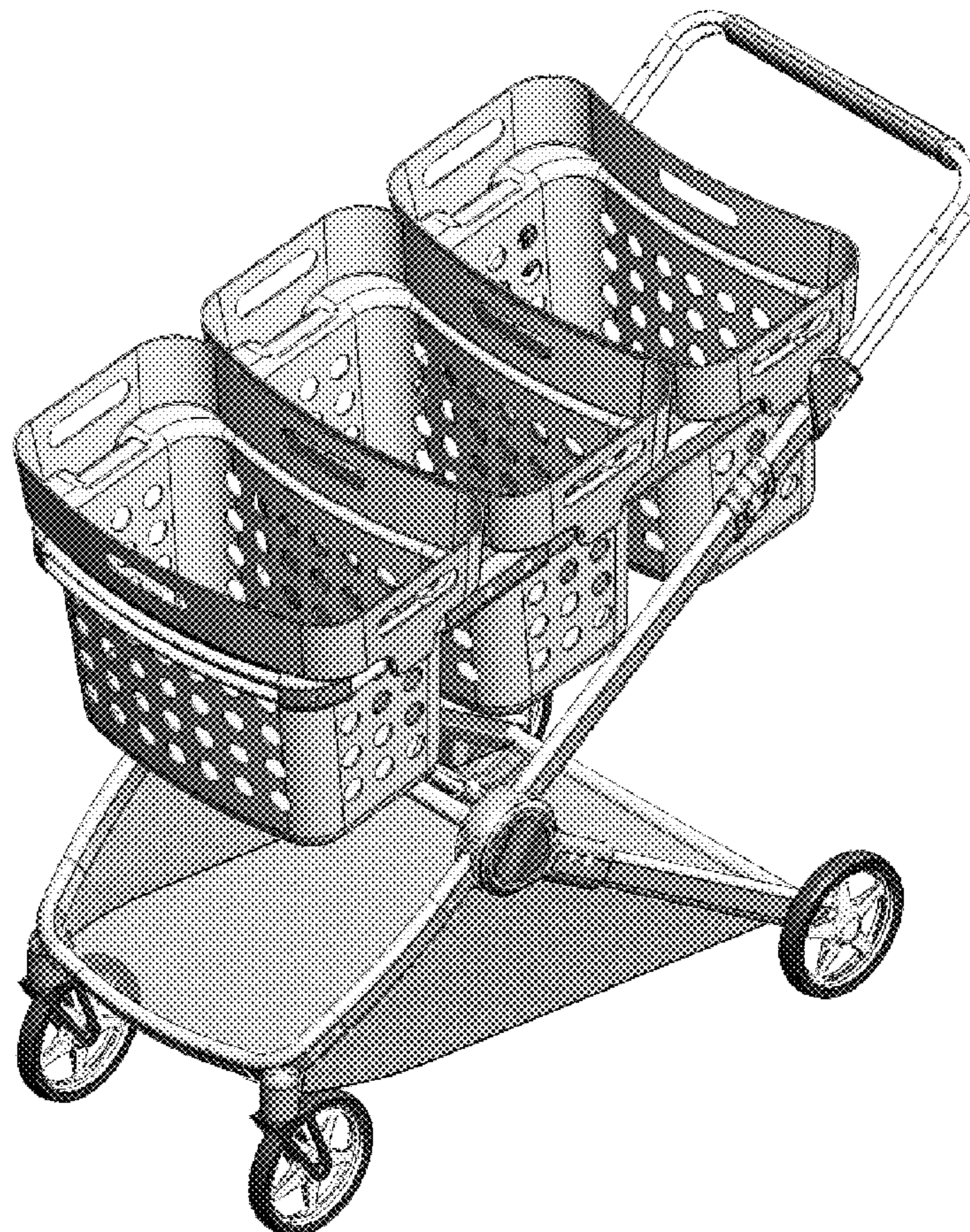

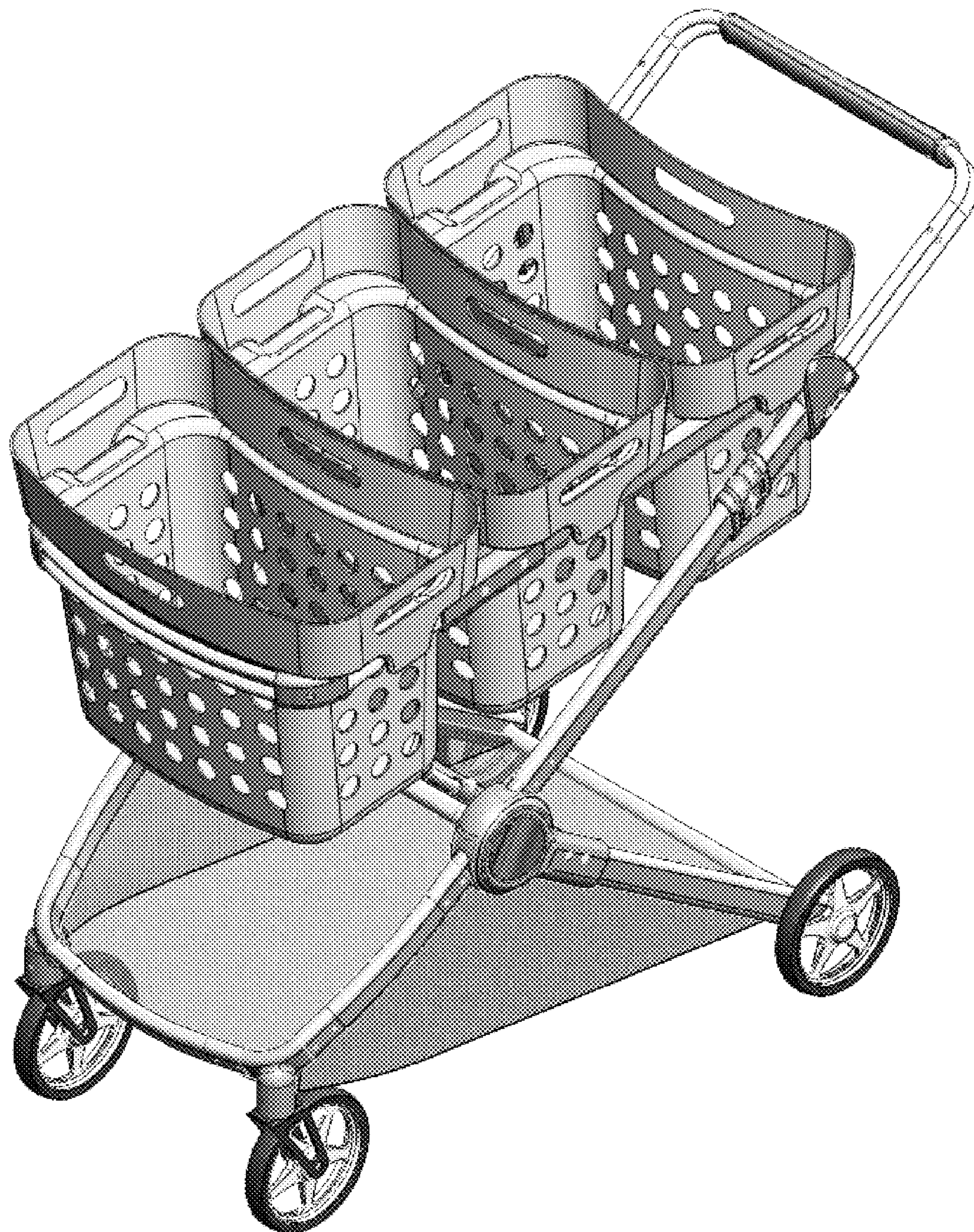

FIG. 1

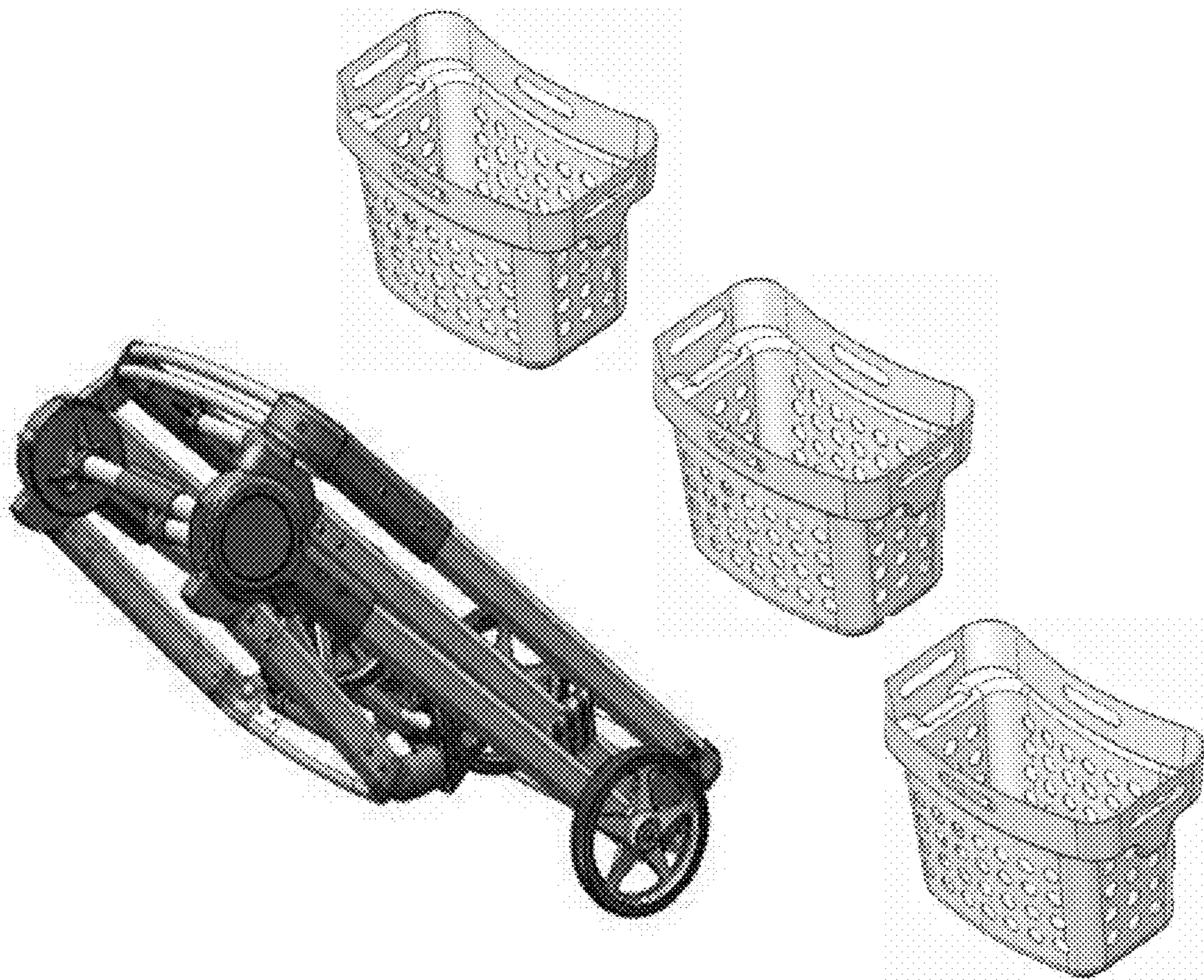

FIG. 2

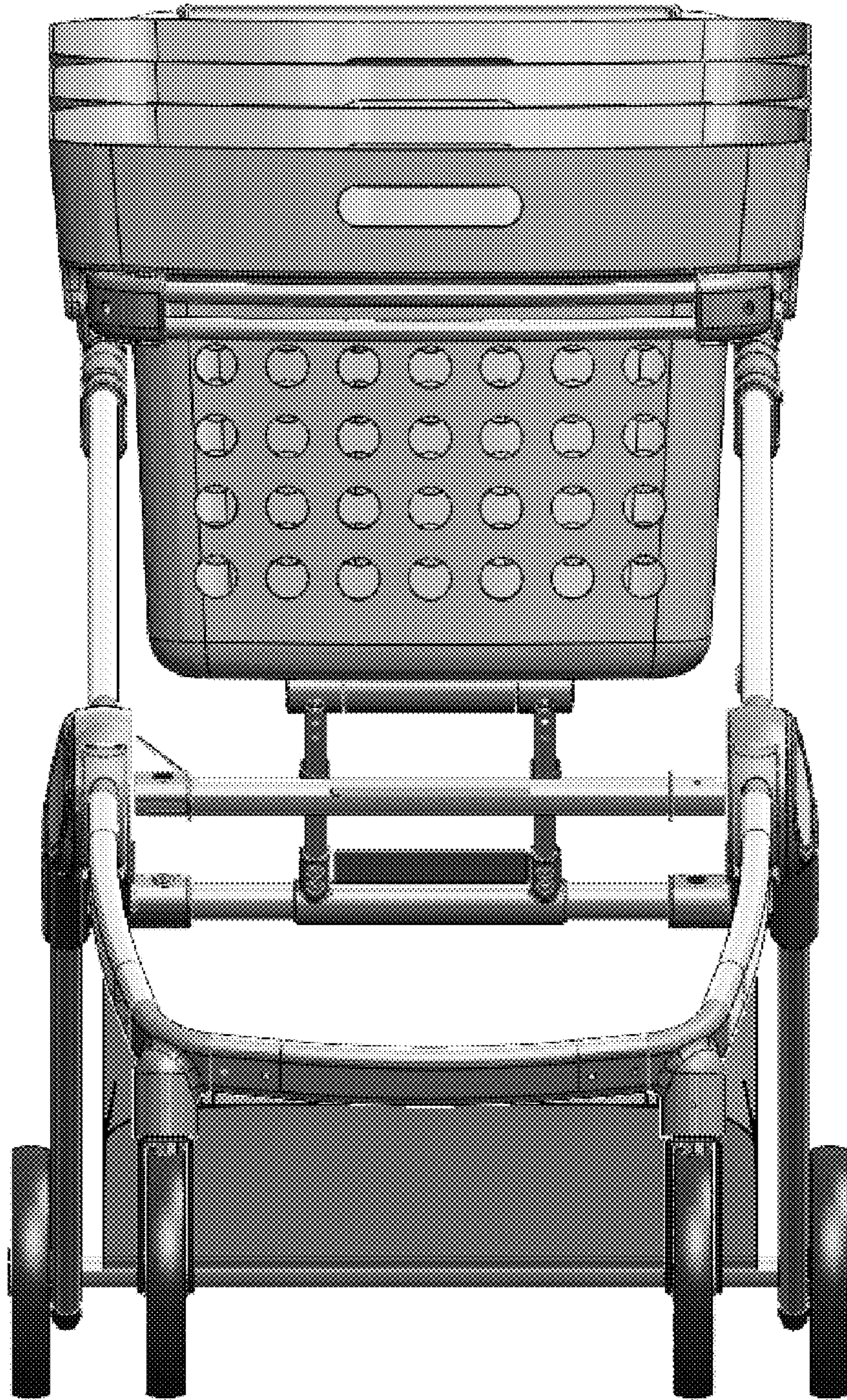

FIG. 3

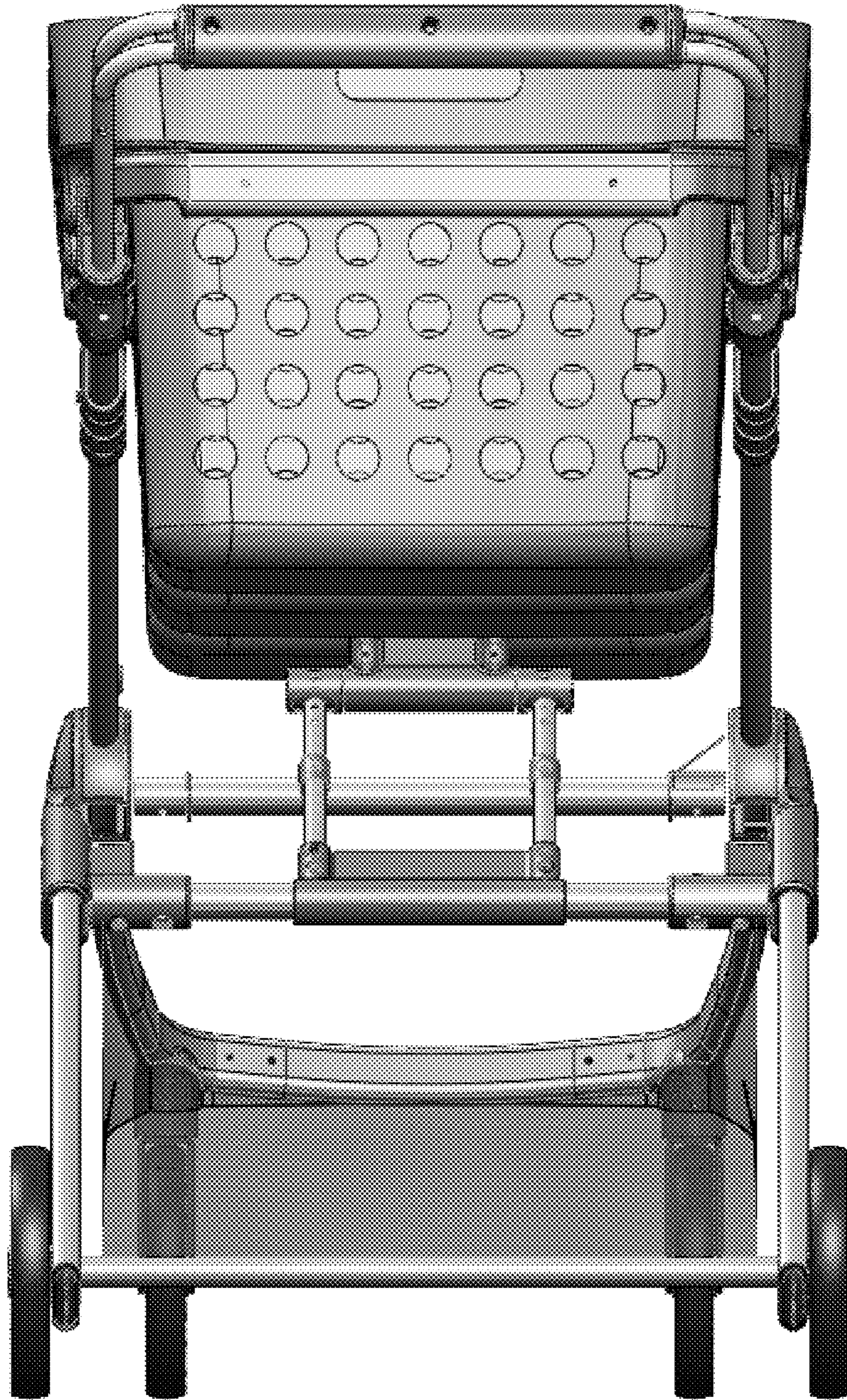

FIG. 4

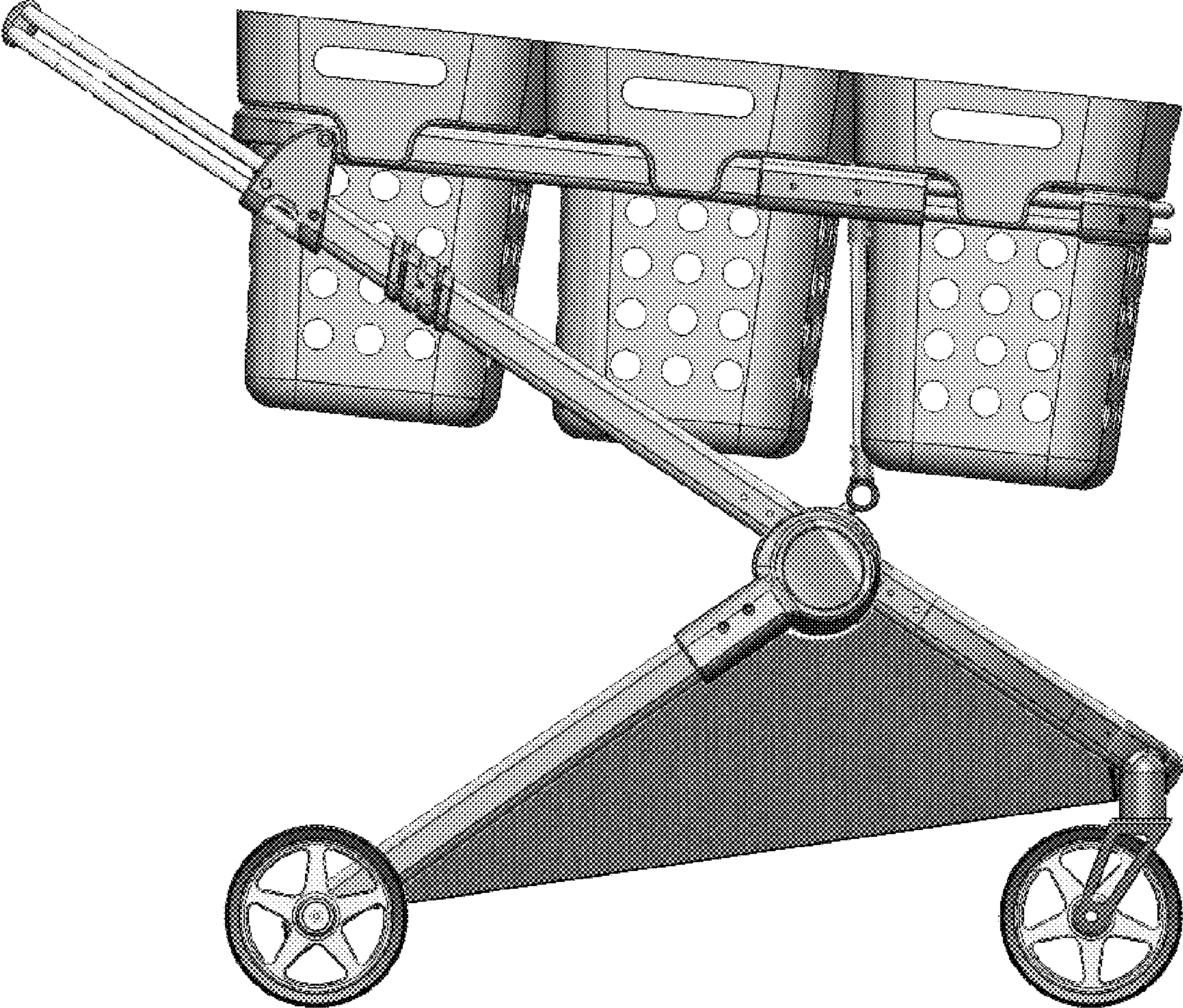

FIG. 5

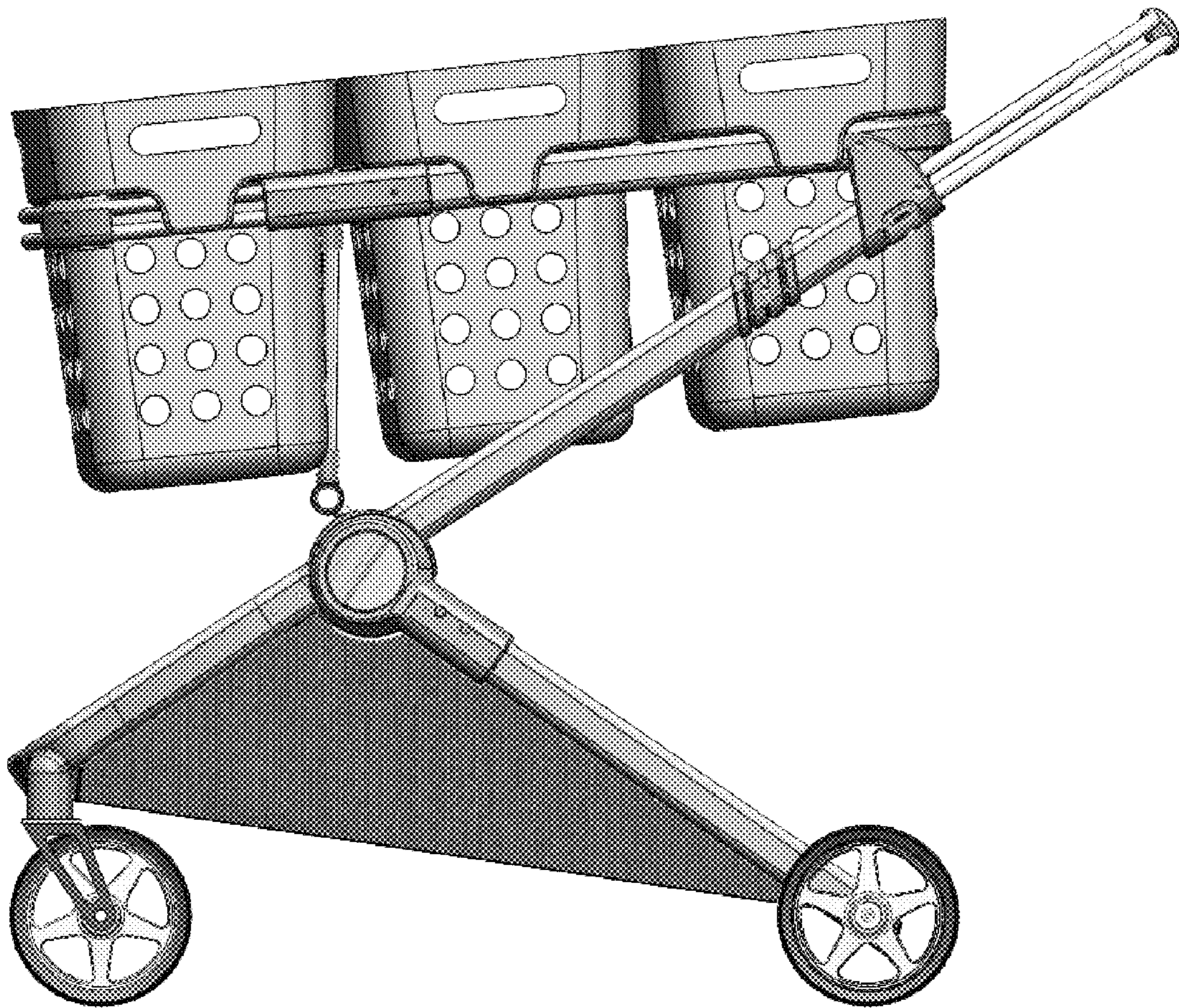

FIG. 6

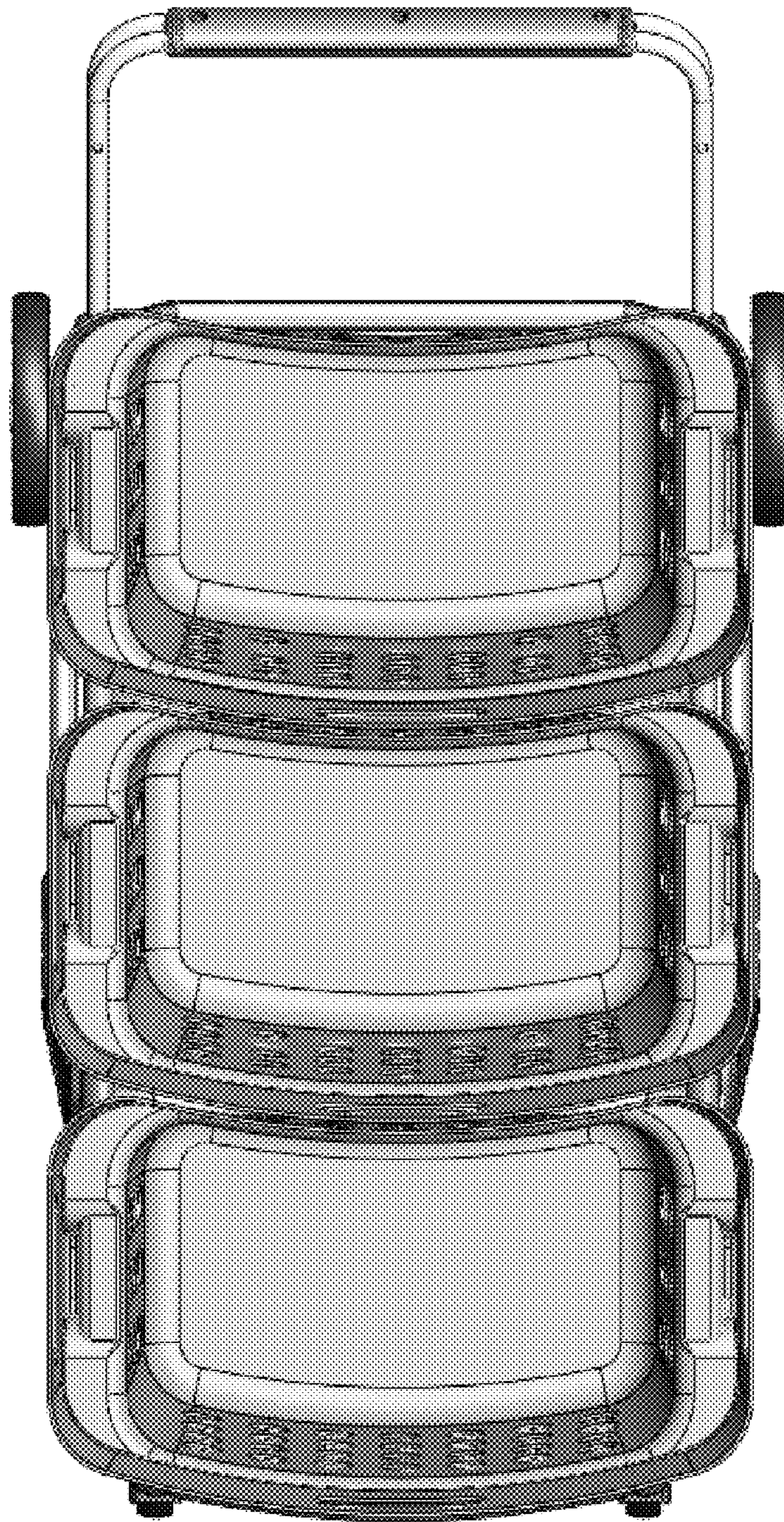

FIG. 7