



US00D651744S

(12) **United States Design Patent**
Schmitz

(10) **Patent No.:** **US D651,744 S**
(45) **Date of Patent:** **** Jan. 3, 2012**

(54) **HAIR FORMING DEVICE**

(75) Inventor: **Ingo Schmitz**, Duisburg (DE)

(73) Assignee: **WIK Far East Ltd.**, Hong Kong (CN)

(**) Term: **14 Years**

(21) Appl. No.: **29/391,435**

(22) Filed: **May 9, 2011**

(30) **Foreign Application Priority Data**

Nov. 25, 2010 (DE) 40 2010 005 211

(51) **LOC (9) Cl.** **28-03**

(52) **U.S. Cl.** **D28/35**

(58) **Field of Classification Search** D28/35-38;
131/223-272; 219/222, 225-226

See application file for complete search history.

(56) **References Cited**

U.S. PATENT DOCUMENTS

6,278,086	B1	8/2001	Janouch et al.	
6,895,975	B2	5/2005	Hafemann	
D506,851	S	6/2005	Schmitz	
D541,472	S *	4/2007	Kuchler et al.	D28/35
D550,900	S *	9/2007	Kuchler et al.	D28/35
D551,388	S *	9/2007	Kuchler et al.	D28/35
7,287,532	B2	10/2007	Hafemann	
D570,044	S *	5/2008	Leung	D28/35
D586,039	S *	2/2009	Kim	D28/35
D598,163	S *	8/2009	Overend et al.	D28/35
D598,164	S *	8/2009	Overend et al.	D28/35
D620,639	S *	7/2010	Choi	D28/35
D627,513	S *	11/2010	Kim	D28/35
2010/0147323	A1	6/2010	Hafemann	
2010/0147324	A1	6/2010	Hafemann	

FOREIGN PATENT DOCUMENTS

DE	19750119	5/1999
DE	20200971	6/2002
EP	1472951	11/2004
FR	2913570	9/2008
WO	03031416	4/2003

OTHER PUBLICATIONS

U.S. Appl. No. 29/367,319, filed Aug. 5, 2010; First Named Inventor:
Ingo Schmitz.

U.S. Appl. No. 29/367,320, filed Aug. 5, 2010; First Named Inventor:
Ingo Schmitz.

* cited by examiner

Primary Examiner — Jennifer Rivard

(74) *Attorney, Agent, or Firm* — Margaret Polson; Oppedahl
Patent Law Firm LLC

(57) **CLAIM**

The ornamental design for a hair forming device, as shown
and described.

DESCRIPTION

FIG. 1 is a front perspective view of my new design for a hair
forming device in the open position.

FIG. 2 is a front side elevation view the hair forming device in
the closed position.

FIG. 3 is a back side elevation view of FIG. 2, the power cord
attachment location show in dotted lines is for illustrative
purposes only and is not part of the claimed design.

FIG. 4 is a left side elevation view of FIG. 2, the right side
elevation view is a mirror image.

FIG. 5 is a top plan view of FIG. 2; and,

FIG. 6 is a bottom plan view of FIG. 2.

1 Claim, 2 Drawing Sheets

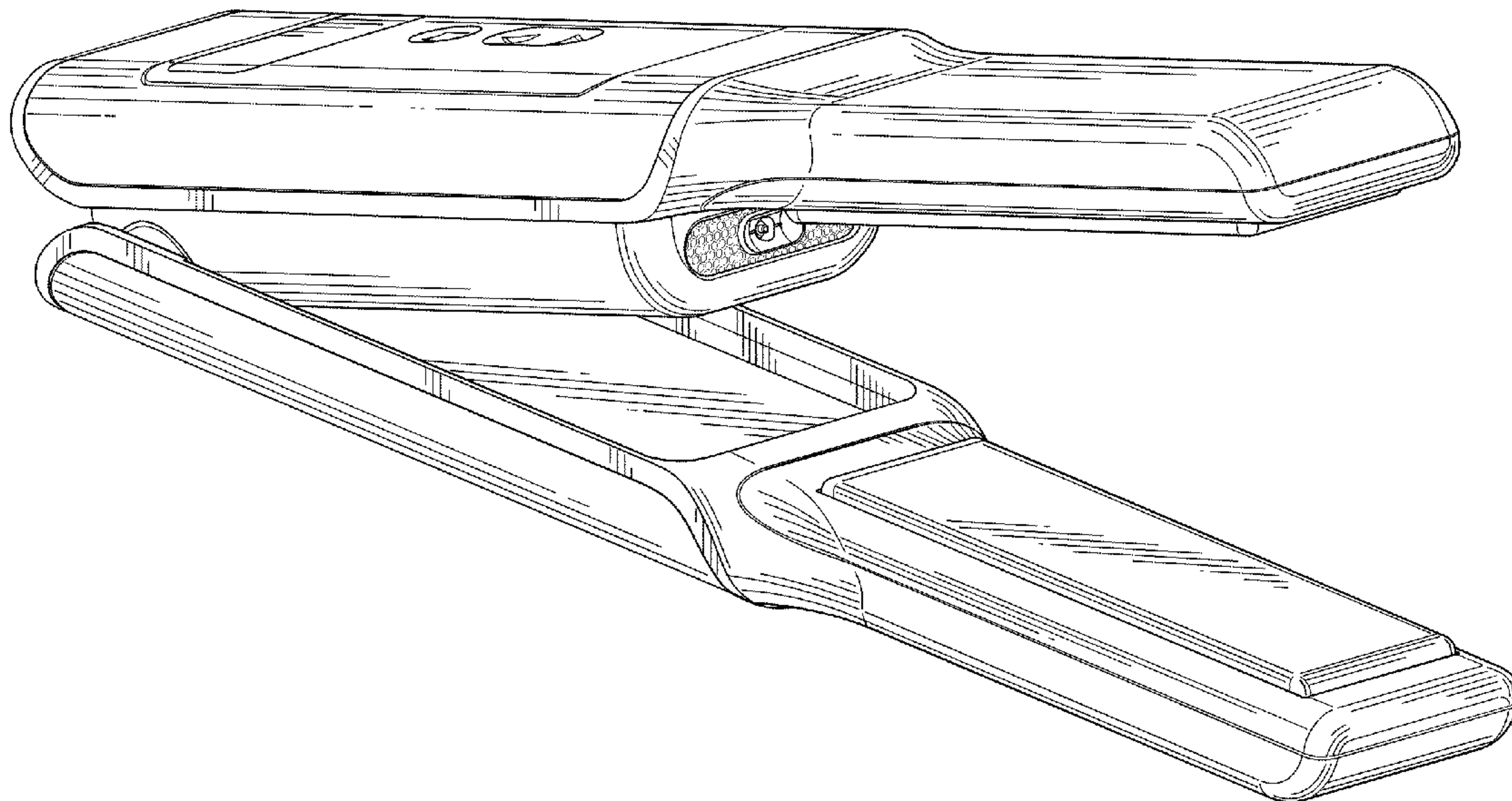

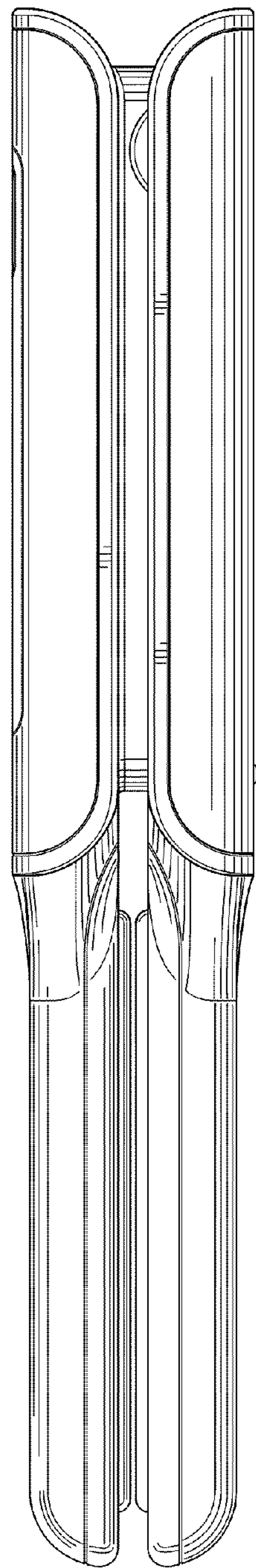
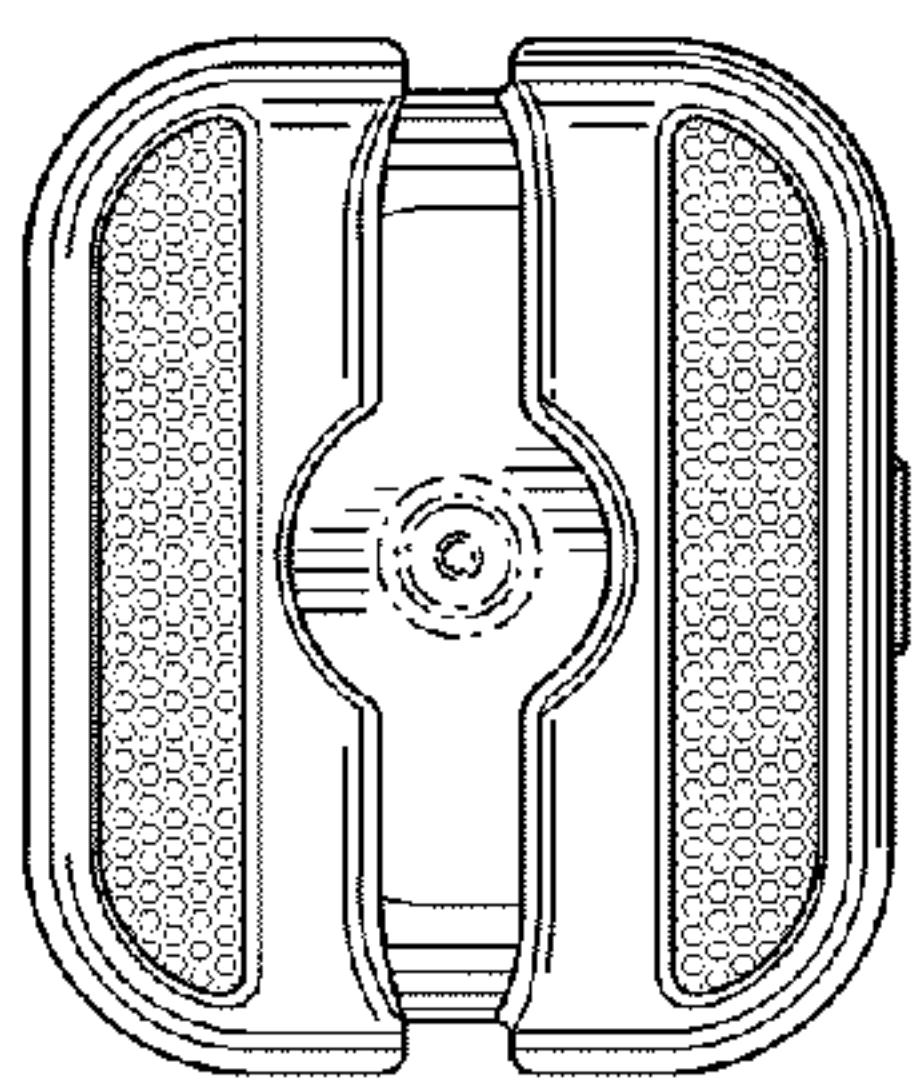
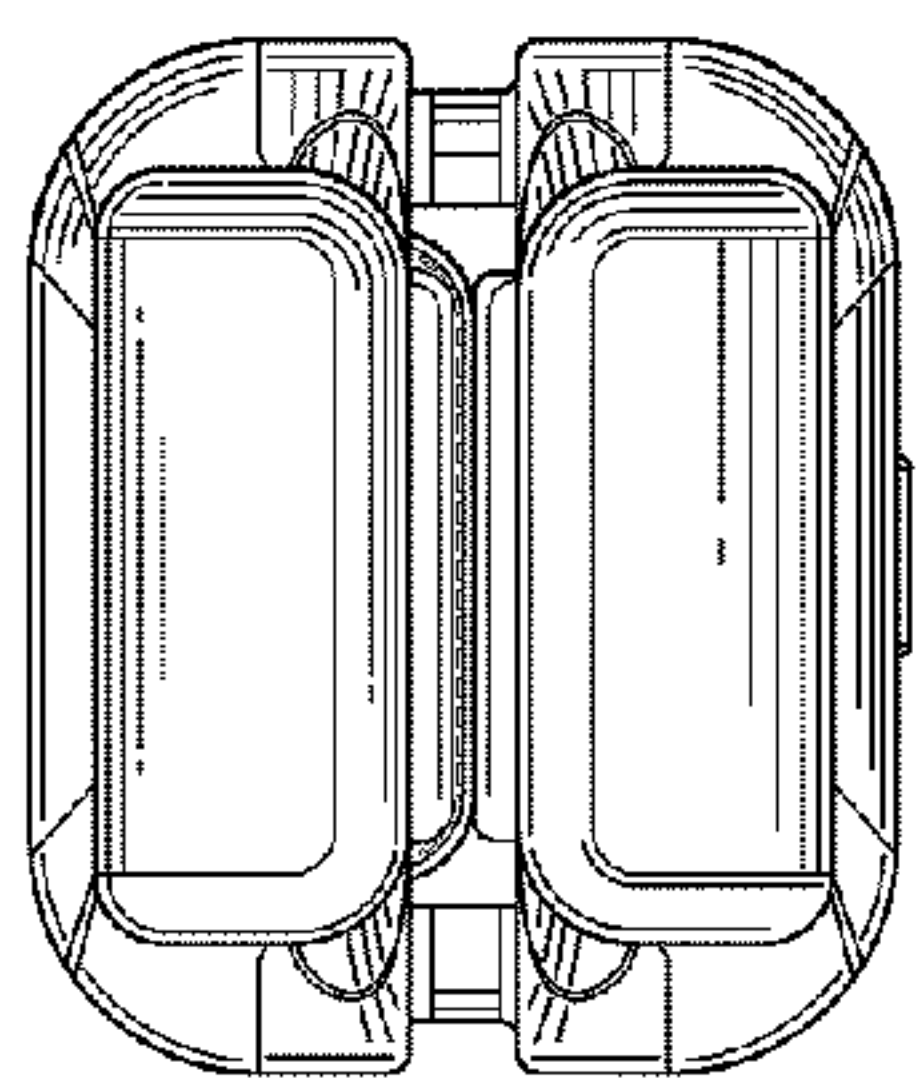
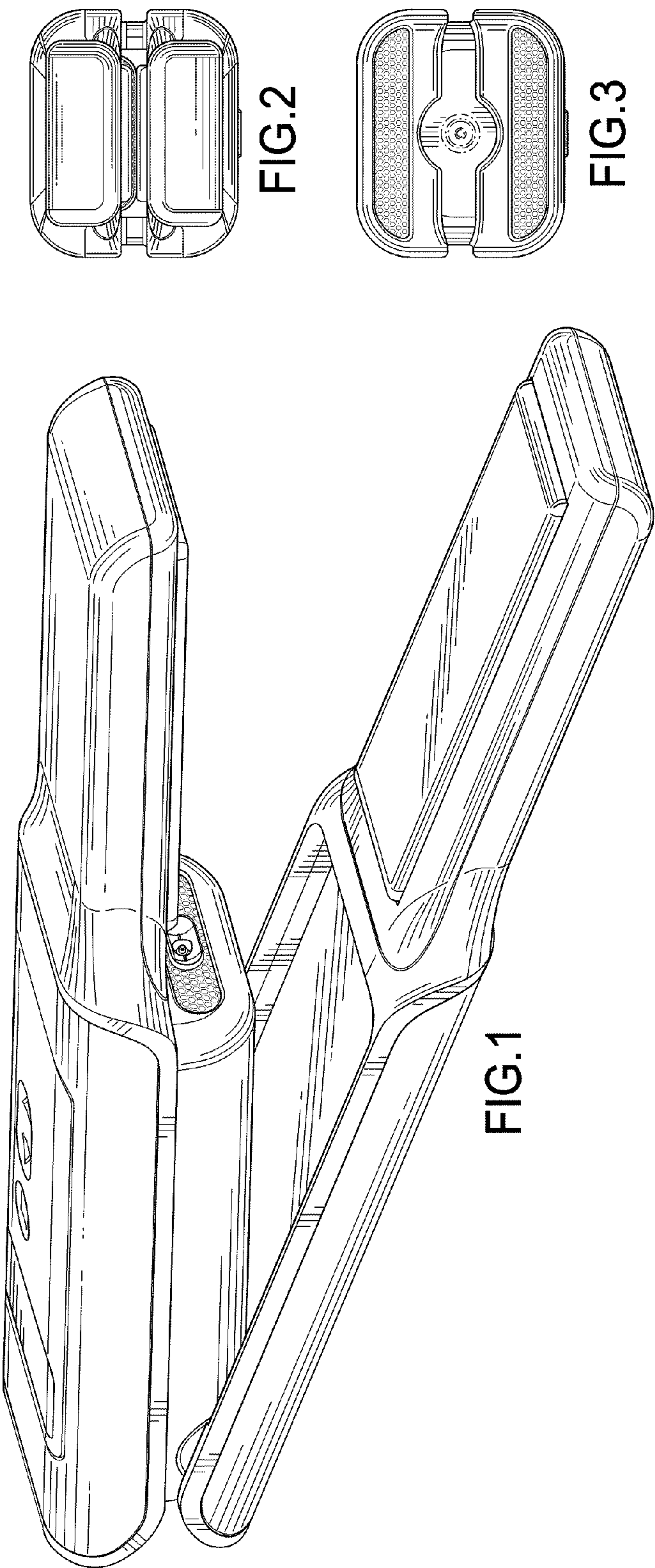

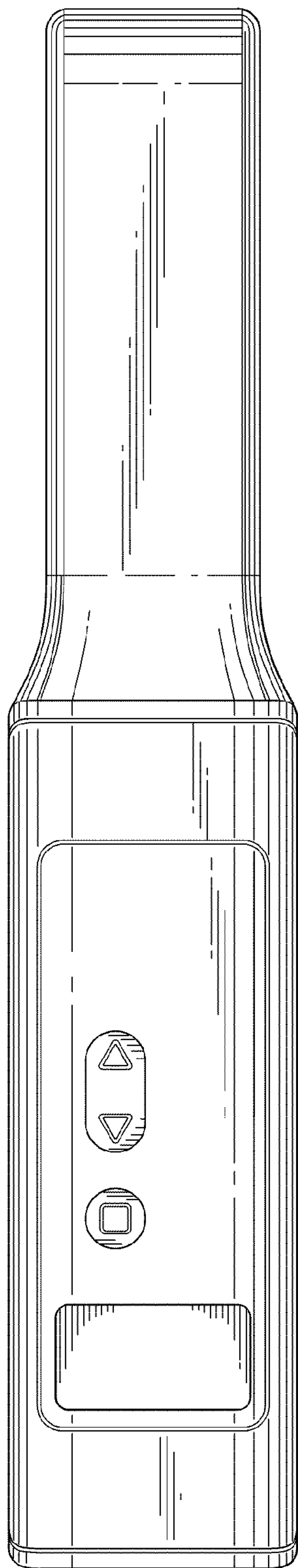

FIG.5

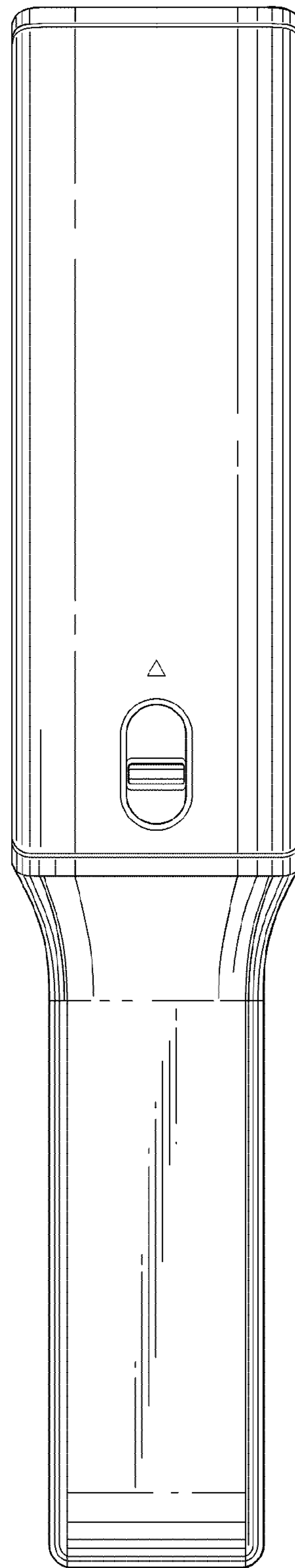

FIG.6