



US00D651743S

(12) **United States Design Patent**
Kim

(10) **Patent No.:** **US D651,743 S**

(45) **Date of Patent:** **** Jan. 3, 2012**

(54) **HAIR IRON**

(75) **Inventor:** **Hae Jin Kim**, Seoul-si (KR)

(73) **Assignee:** **GHD Korea, Inc.**, Chungcheongnam-Do (KR)

(**) **Term:** **14 Years**

(21) **Appl. No.:** **29/381,003**

(22) **Filed:** **Dec. 14, 2010**

(30) **Foreign Application Priority Data**

Nov. 17, 2010 (KR) 30-2010-0049541

(51) **LOC (9) Cl.** **28-03**

(52) **U.S. Cl.** **D28/35**

(58) **Field of Classification Search** D28/35,
D28/38; 132/223-236; 219/222, 225-227,
219/242

See application file for complete search history.

(56) **References Cited**

U.S. PATENT DOCUMENTS

D550,900 S * 9/2007 Kuchler et al. D28/35

D551,388 S * 9/2007 Kuchler et al. D28/35

D570,044 S * 5/2008 Leung D28/35

D586,039 S * 2/2009 Kim D28/35

7,931,031 B2 * 4/2011 LeGrain 132/269

* cited by examiner

Primary Examiner — Jennifer Rivard

(74) *Attorney, Agent, or Firm* — Duane Morris LLP; J. Rodman Steele, Jr.; Gregory M. Lefkowitz

(57) **CLAIM**

The ornamental design for a hair iron, as shown and described.

DESCRIPTION

FIG. 1 is a perspective view of a hair iron in accordance with the new design;

FIG. 2 is a front elevational view thereof;

FIG. 3 is a rear elevational view thereof;

FIG. 4 is a left side elevational view thereof;

FIG. 5 is a right side elevational view thereof;

FIG. 6 is a top plan view thereof; and,

FIG. 7 is a bottom plan view thereof.

The broken lines shown in the drawings illustrate portions of the article and form no part of the claimed design.

1 Claim, 3 Drawing Sheets

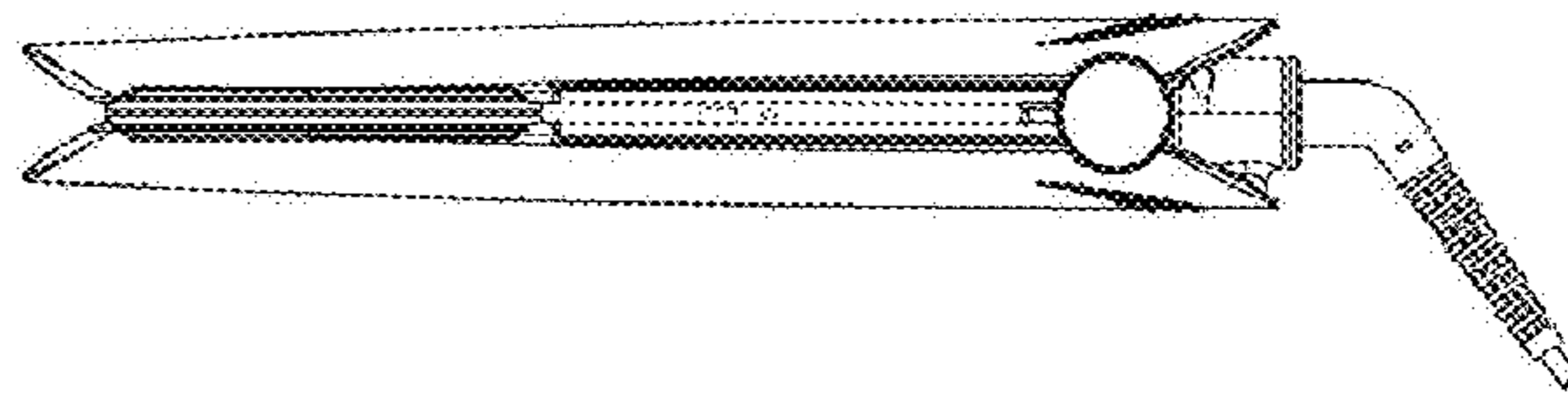
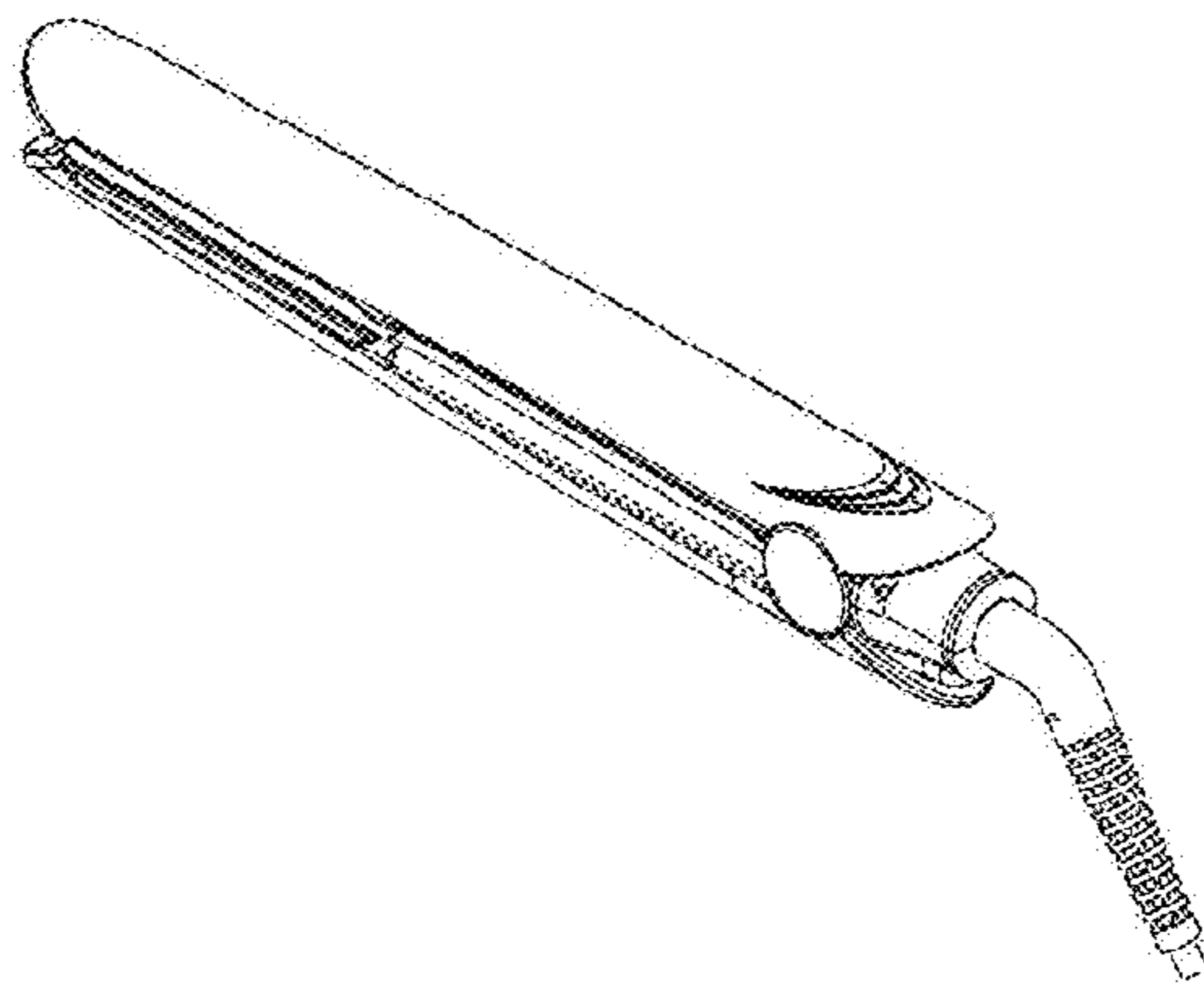

Fig. 1

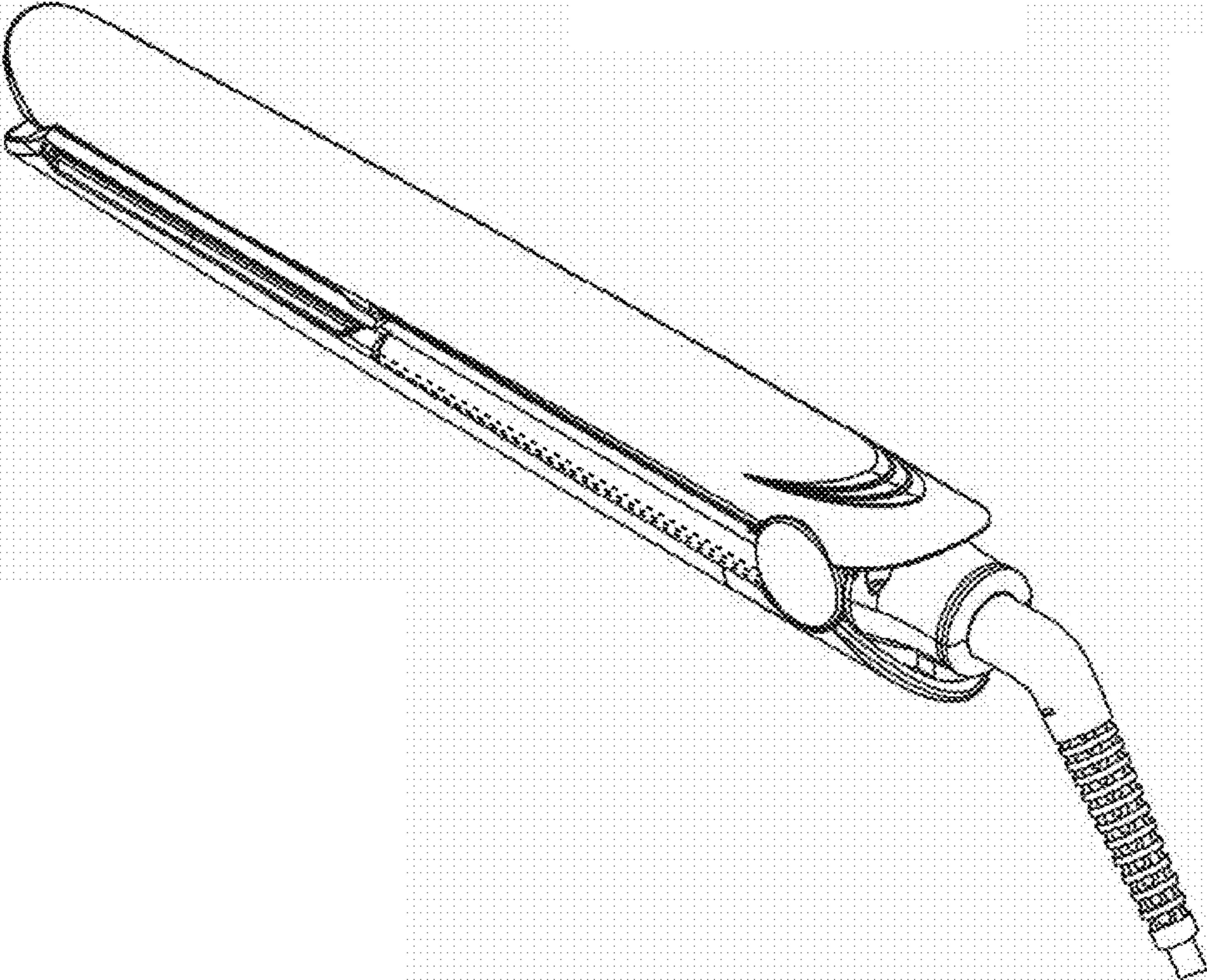

Fig. 2

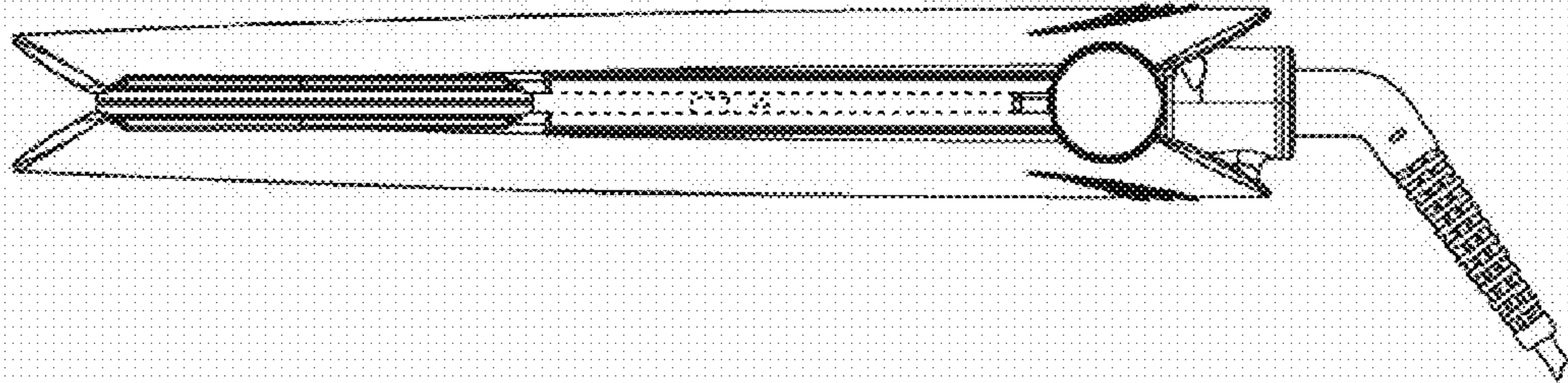

Fig. 3

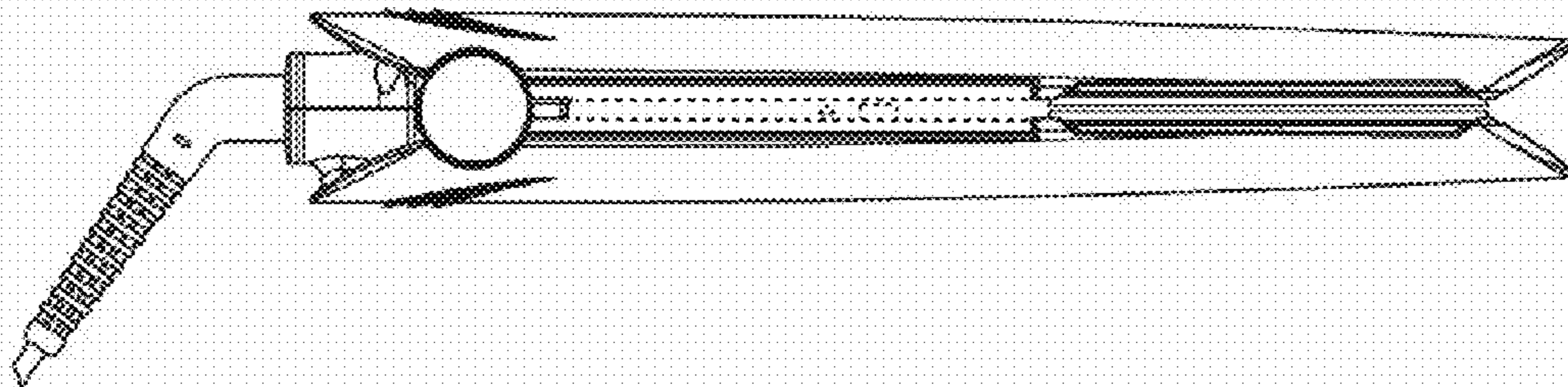

Fig. 4

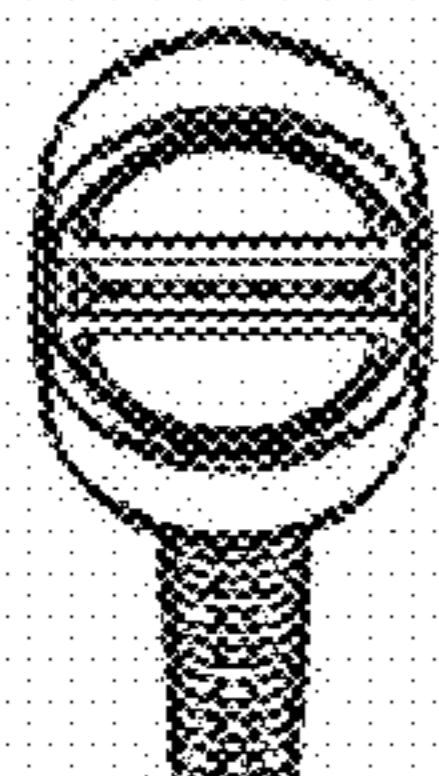

Fig. 5

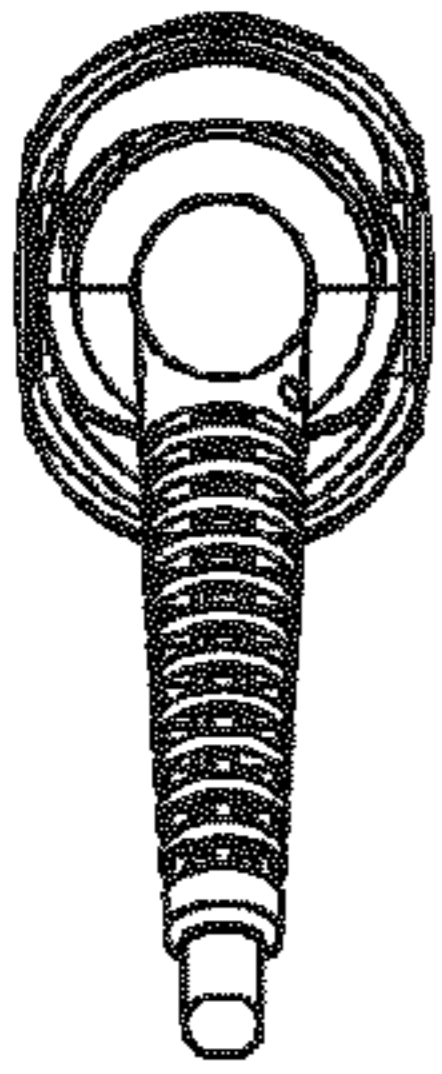

Fig. 6

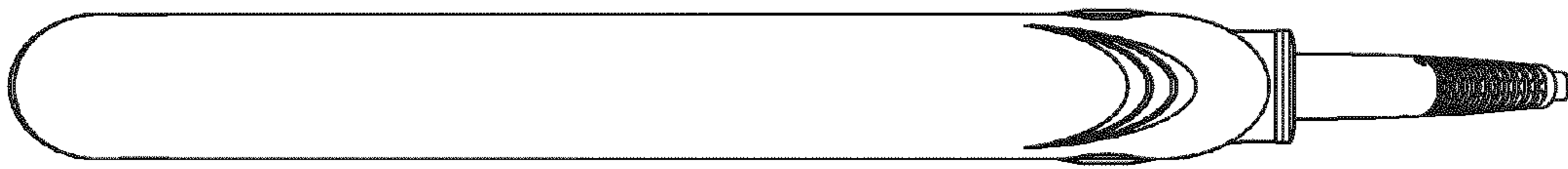

Fig. 7

