

US00D651693S

(12) **United States Design Patent**
Flowers et al.

(10) **Patent No.:** **US D651,693 S**
(45) **Date of Patent:** **** Jan. 3, 2012**

(54) **VALVE**

(75) Inventors: **Paul Flowers**, Duesseldorf (DE); **Jochen Allard**, Menden (DE)

(73) Assignee: **Grohe AG**, Hemer (DE)

(**) Term: **14 Years**

(21) Appl. No.: **29/388,339**

(22) Filed: **Mar. 28, 2011**

(51) **LOC (9) Cl.** **23-01**

(52) **U.S. Cl.** **D23/252; D23/254**

(58) **Field of Classification Search** D23/250,
D23/252, 254, 238-243; 4/676-677; 137/801,
137/359; D8/350-353

See application file for complete search history.

(56) **References Cited**

U.S. PATENT DOCUMENTS

D459,445 S * 6/2002 Mullenmeister D23/254

D574,468 S * 8/2008 Wolf D23/254
* cited by examiner

Primary Examiner — Robert Delehanty

(74) *Attorney, Agent, or Firm* — Muncy, Geissler, Olds & Lowe, PLLC

(57) **CLAIM**

The ornamental design for a valve, as shown and described.

DESCRIPTION

FIG. 1 is a left side elevational view of the valve of the present invention, the right side elevational view being a mirror image thereof.

FIG. 2 is a front elevational view of the valve of FIG. 1.

FIG. 3 is a rear elevation view of the valve of FIG. 1.

FIG. 4 is a top plan view of the valve of FIG. 1.

FIG. 5 is a bottom plan view of the valve of FIG. 1; and,

FIG. 6 is a three-quarter view of the valve of FIG. 1.

The dashed lines illustrate environment that does not form a part of the present invention, and no claim is made to the material illustrated with dashed lines.

1 Claim, 6 Drawing Sheets

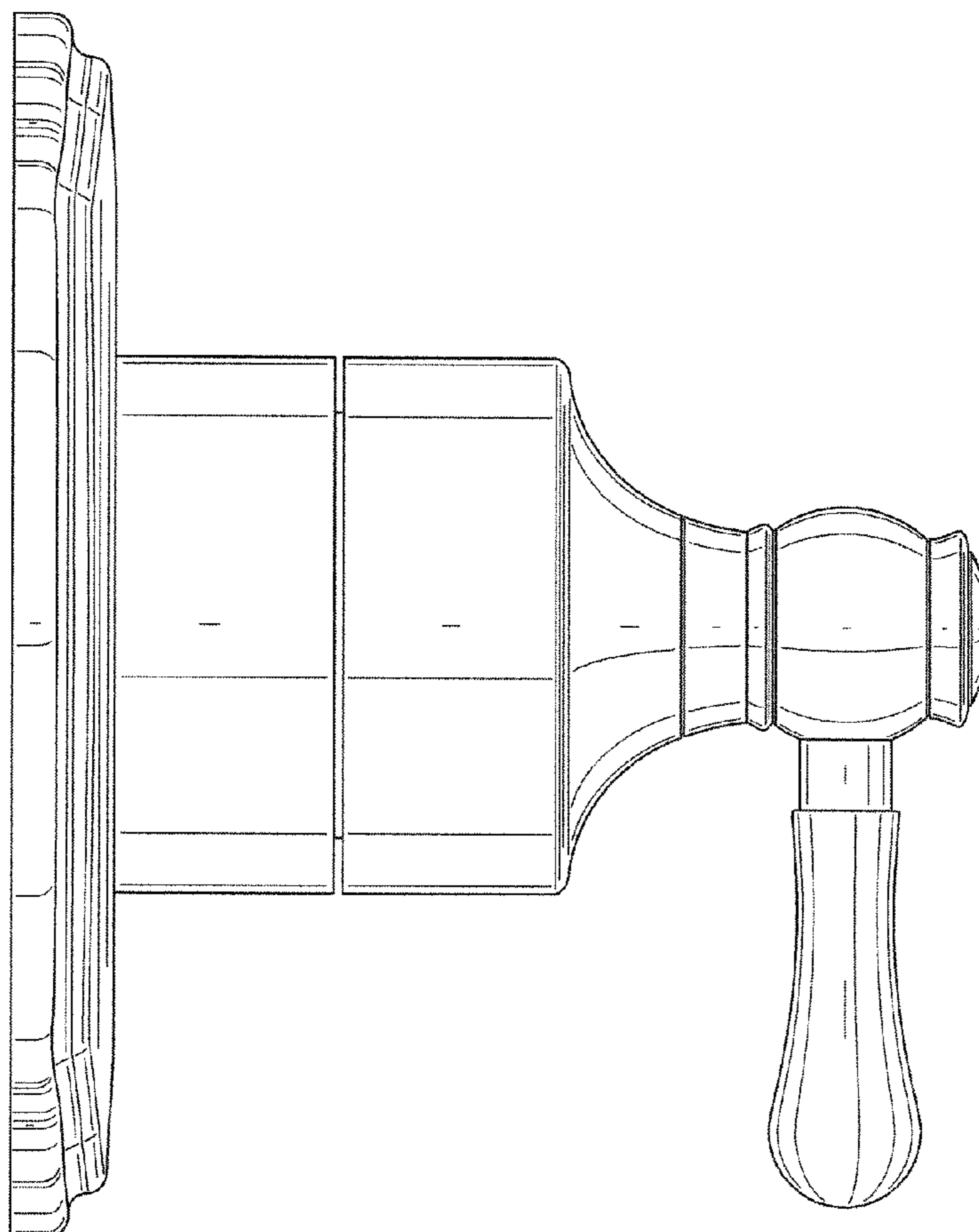

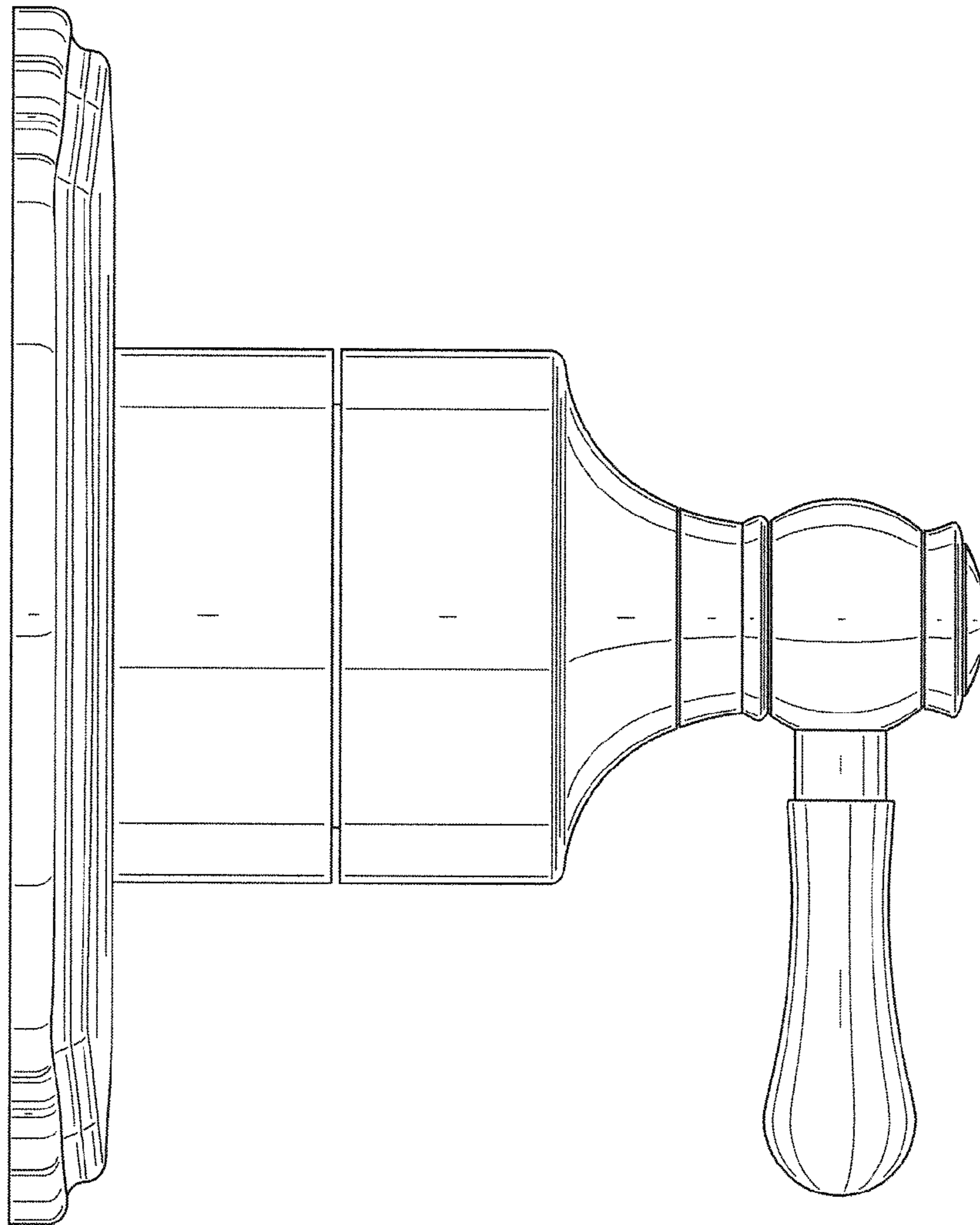

FIG. 1

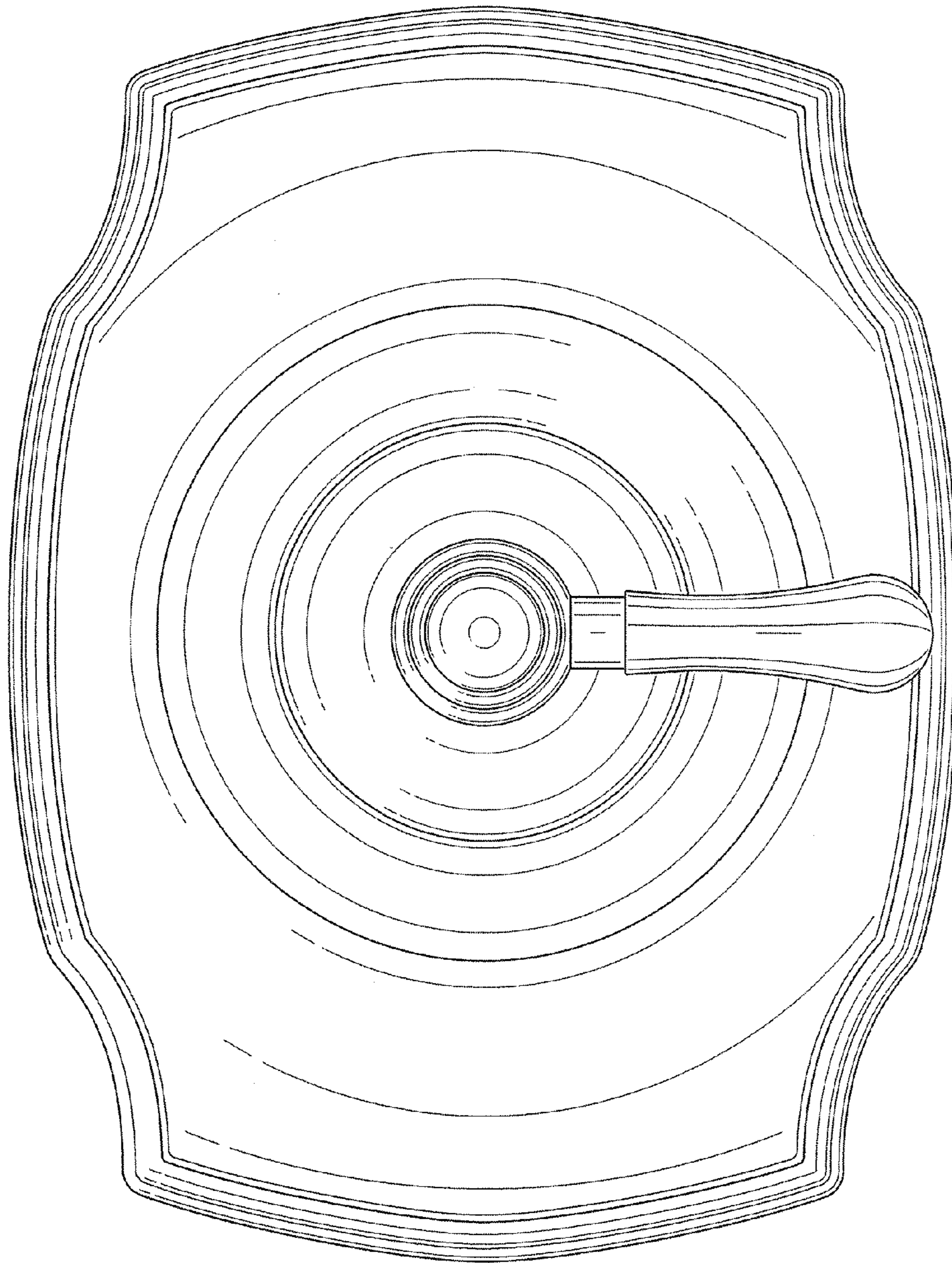

FIG. 2

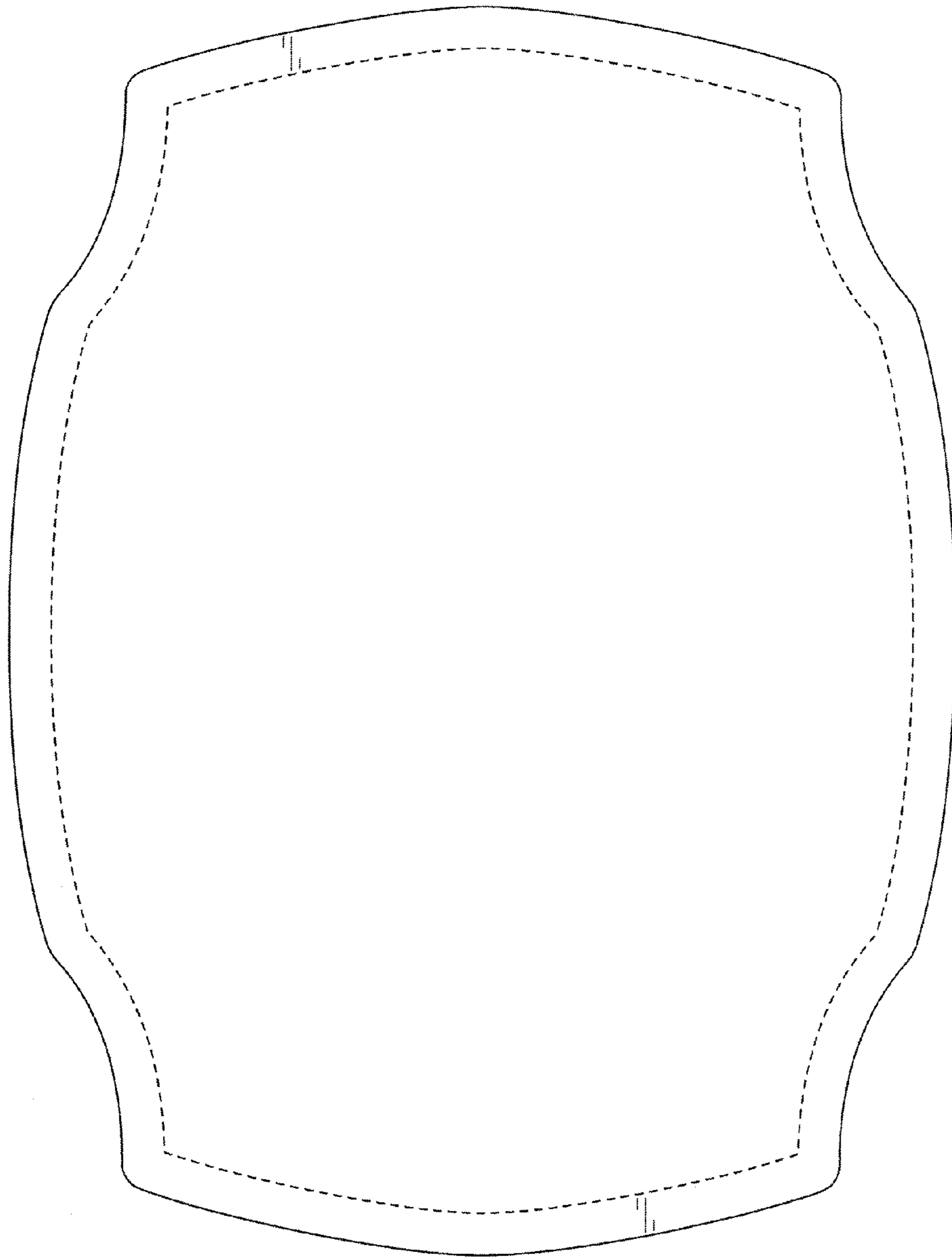

FIG. 3

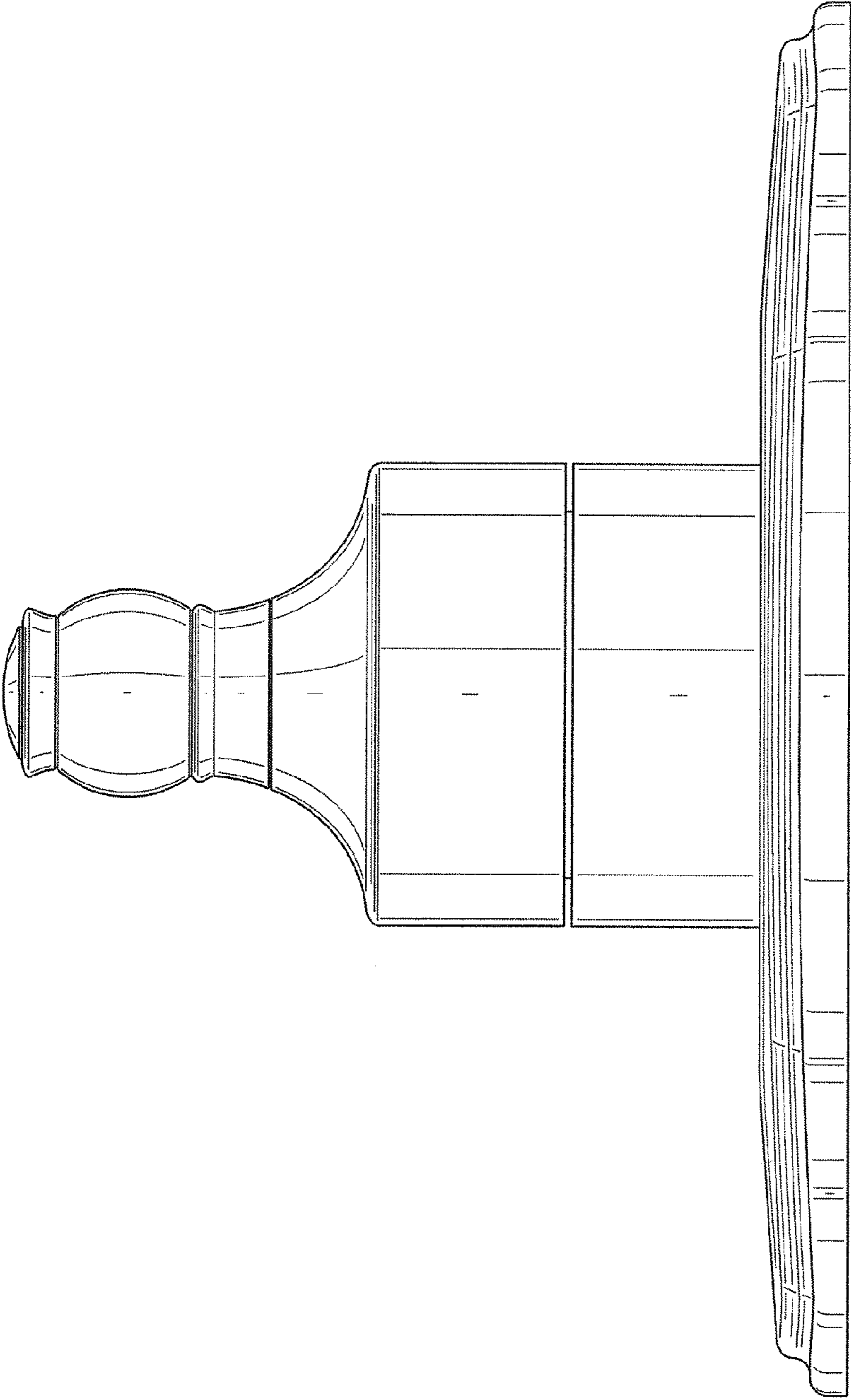

FIG. 4

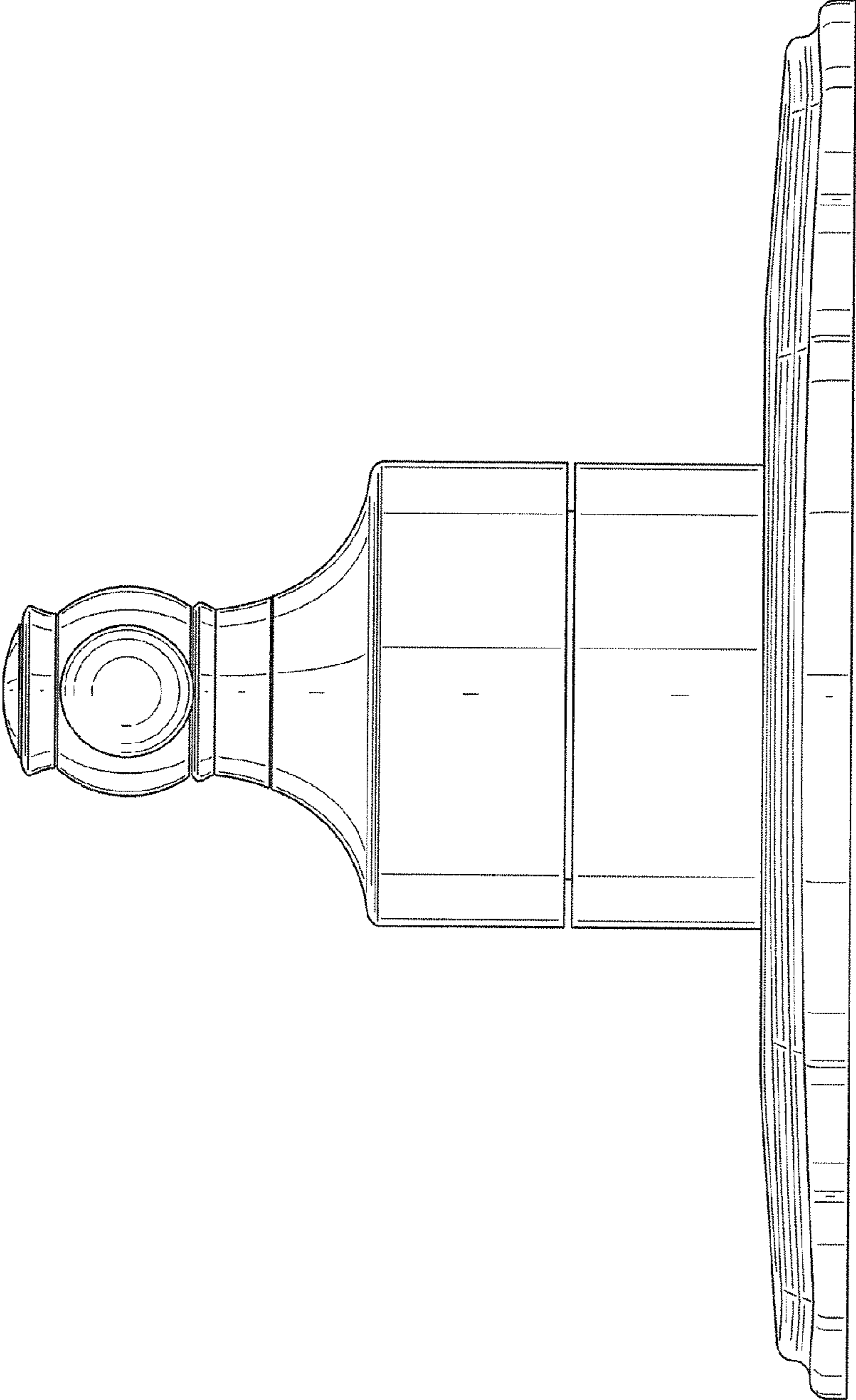

FIG. 5

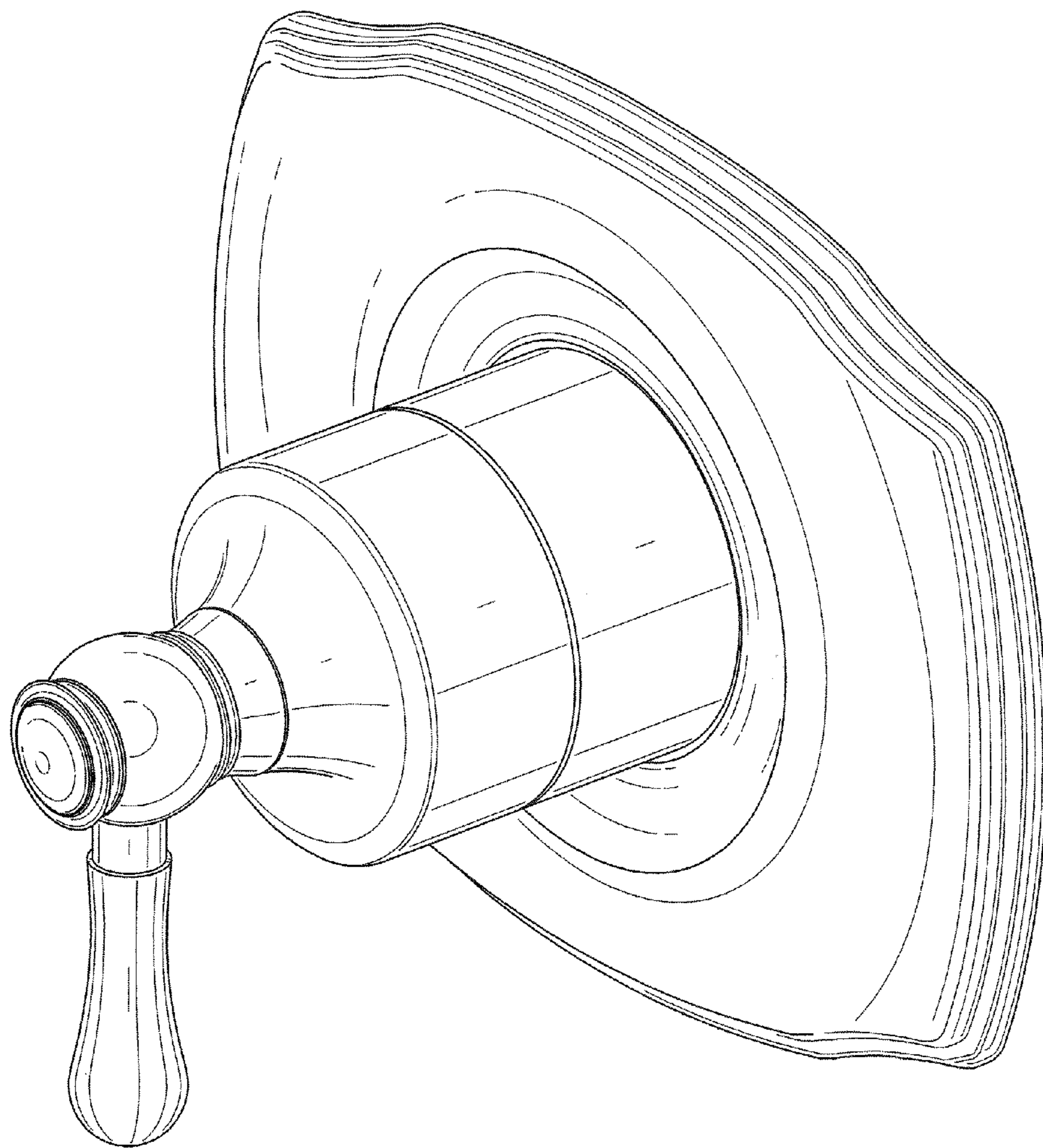

FIG. 6