



US00D651586S

(12) **United States Design Patent**  
**Lee et al.**

(10) **Patent No.:** **US D651,586 S**  
(45) **Date of Patent:** **\*\* Jan. 3, 2012**

(54) **OVER-EAR HEADPHONES**

(75) Inventors: **Noel Lee**, Las Vegas, NV (US);  
**Kendrew Lee**, Tsing Yi (HK)

(73) Assignee: **Monster Cable Products, Inc.**,  
Brisbane, CA (US)

(\*\*) Term: **14 Years**

(21) Appl. No.: **29/382,543**

(22) Filed: **Jan. 5, 2011**

(51) **LOC (9) Cl.** ..... **14-01**

(52) **U.S. Cl.** ..... **D14/205**

(58) **Field of Classification Search** ..... D14/205,

D14/206, 223; 181/129, 130, 135; 379/430,  
379/431; 381/380, 381, 383, 371, 372; D29/112;  
2/209; 128/866; 455/90.3, 575.2

See application file for complete search history.

(56) **References Cited**

**U.S. PATENT DOCUMENTS**

3,454,964	A *	7/1969	Brinkhoff	.....	2/209
D222,547	S *	11/1971	Kantor	.....	D14/205
3,661,225	A *	5/1972	Anderson	.....	181/175
3,845,505	A *	11/1974	Davison et al.	.....	2/209
D244,213	S *	5/1977	Besasio	.....	D14/223
D244,300	S *	5/1977	Besasio	.....	D14/205
D244,301	S *	5/1977	Besasio	.....	D14/223
D276,855	S *	12/1984	Falco	.....	D29/112
D313,092	S *	12/1990	Nilsson	.....	D29/112
5,068,923	A *	12/1991	Sjoqvist	.....	2/209

D326,855	S *	6/1992	Bose et al.	.....	D14/223
5,500,958	A *	3/1996	Falco	.....	2/209
5,996,123	A *	12/1999	Leight et al.	.....	2/209
D427,382	S *	6/2000	Leight et al.	.....	D29/112
6,449,806	B1 *	9/2002	Engelhard et al.	.....	24/3.1
D542,774	S *	5/2007	Rausch et al.	.....	D14/206
D576,604	S *	9/2008	Suzuki	.....	D14/205
D594,441	S	6/2009	Lee et al.		
D598,901	S	8/2009	Lee et al.		
D599,781	S	9/2009	Lee et al.		
D600,675	S	9/2009	Lee et al.		
D638,397	S *	5/2011	McManigal	.....	D14/205
D641,725	S *	7/2011	Chong et al.	.....	D14/205

\* cited by examiner

*Primary Examiner* — Paula Greene

(74) *Attorney, Agent, or Firm* — LaRiviere, Grubman & Payne, LLP

(57) **CLAIM**

The ornamental design for over-ear headphones, as shown and described.

**DESCRIPTION**

FIG. 1 is a perspective view of over-ear headphones, showing our design;

FIG. 2 is front view thereof;

FIG. 3 is a rear view thereof;

FIG. 4 is a side view thereof;

FIG. 5 is an opposing side view thereof;

FIG. 6 is a top view thereof; and,

FIG. 7 is a bottom view thereof.

The broken lines form no part of the claimed design.

**1 Claim, 5 Drawing Sheets**

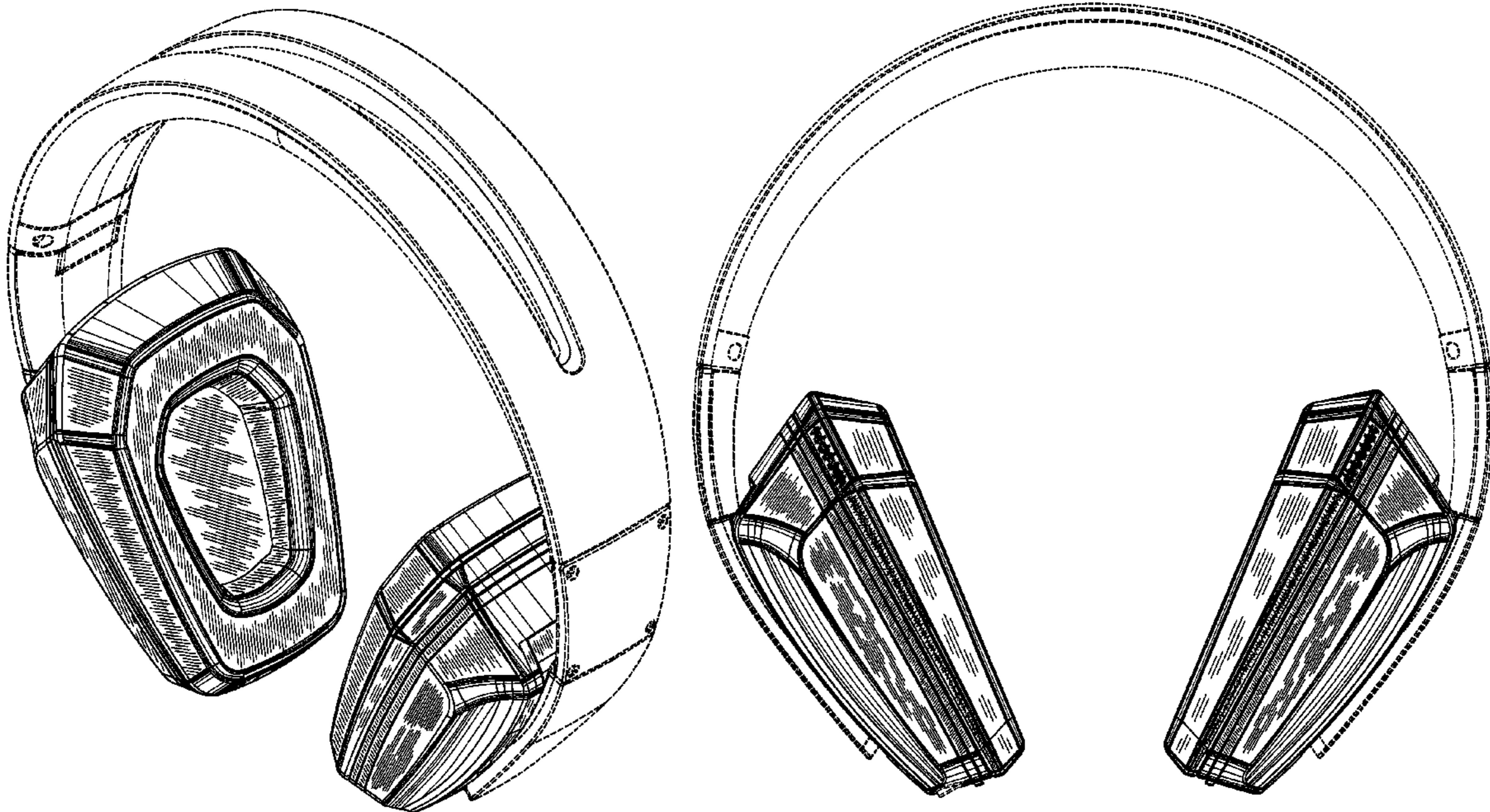



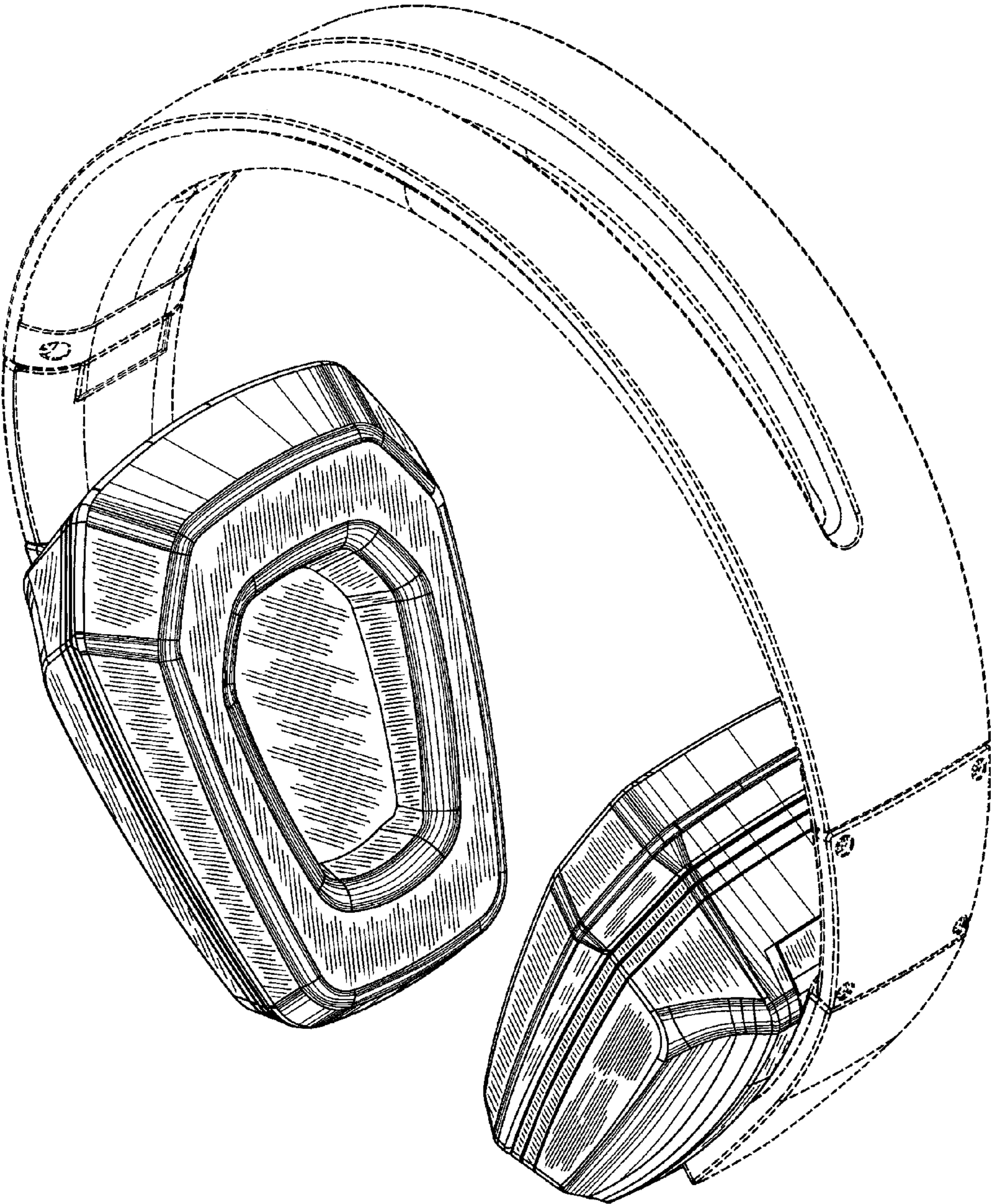

Figure 1

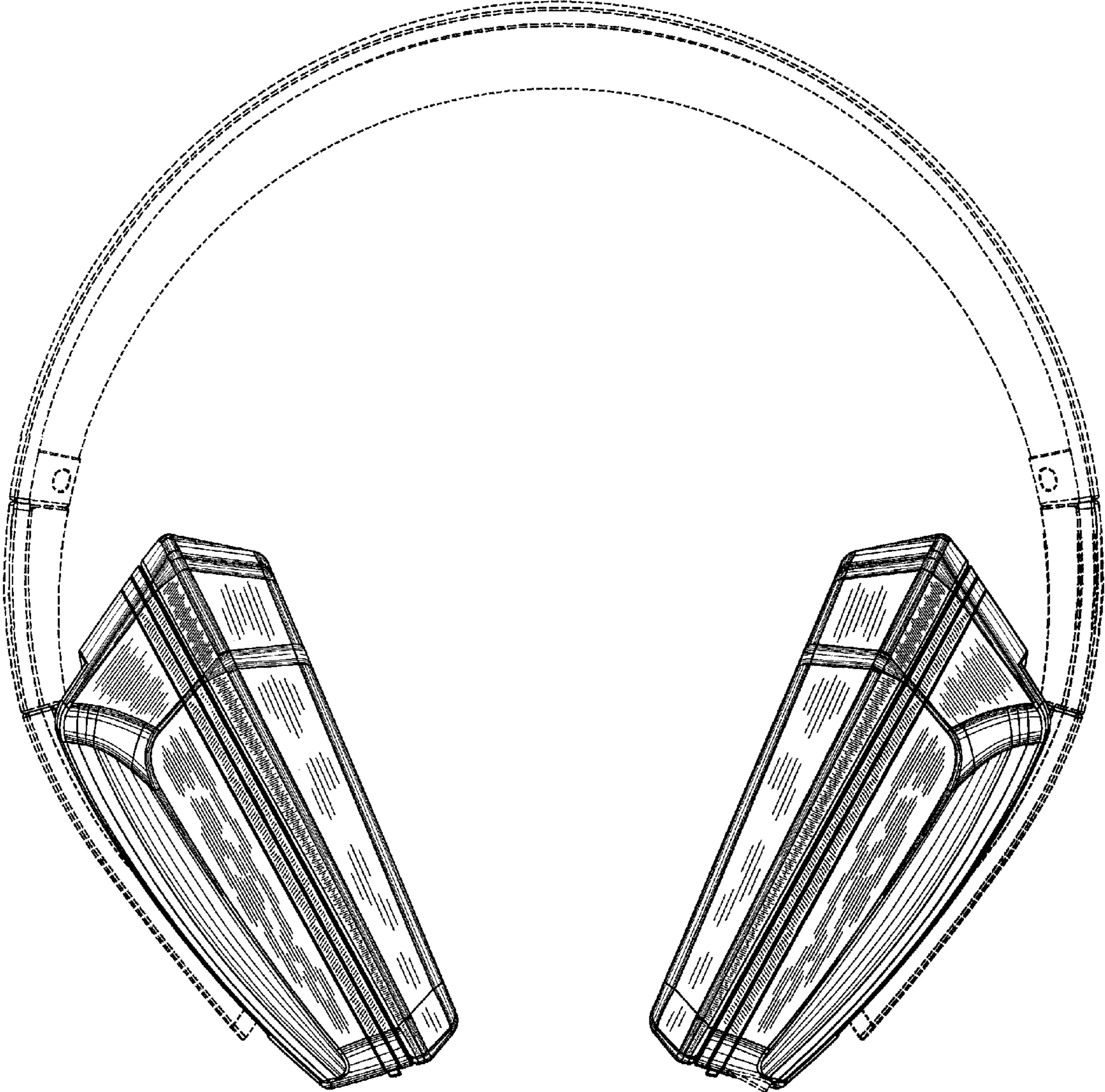

Figure 2



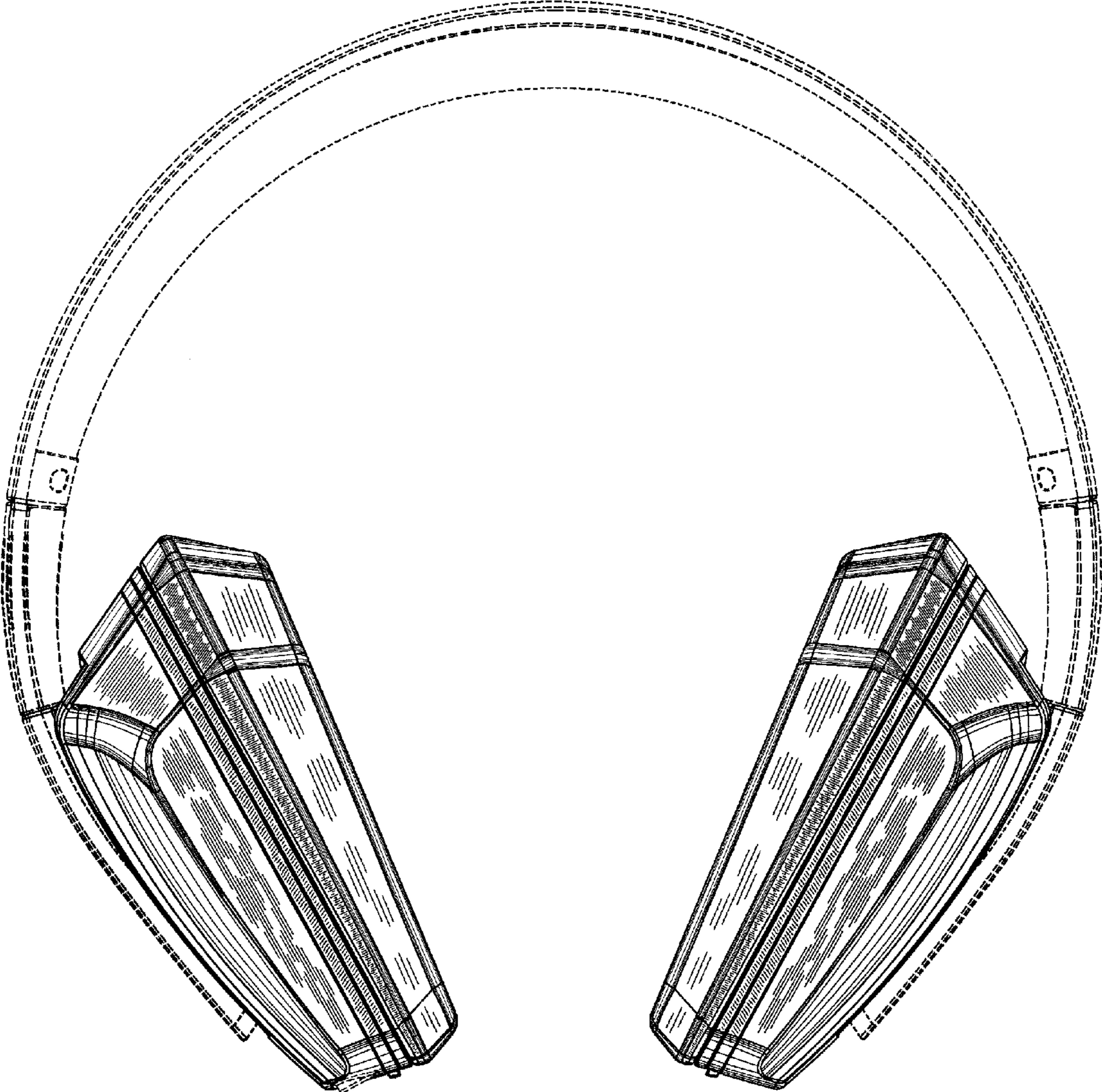

Figure 3

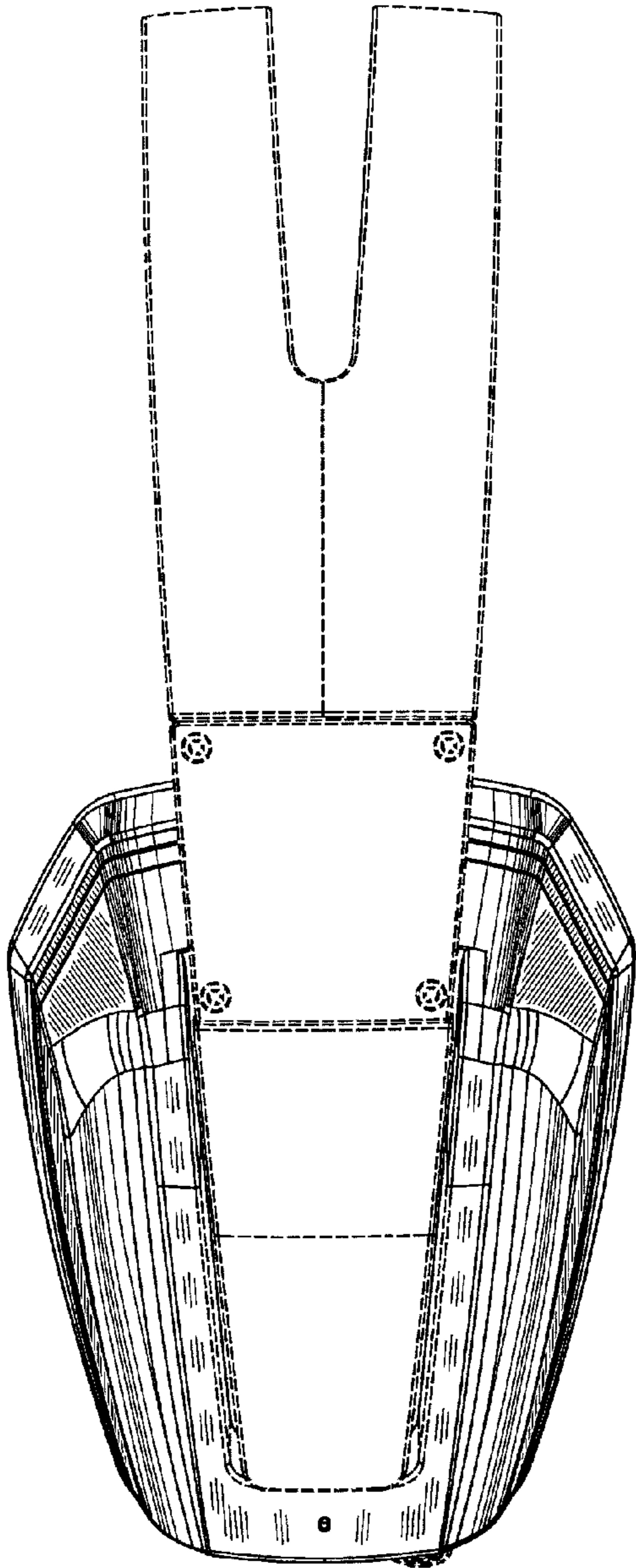

Figure 4

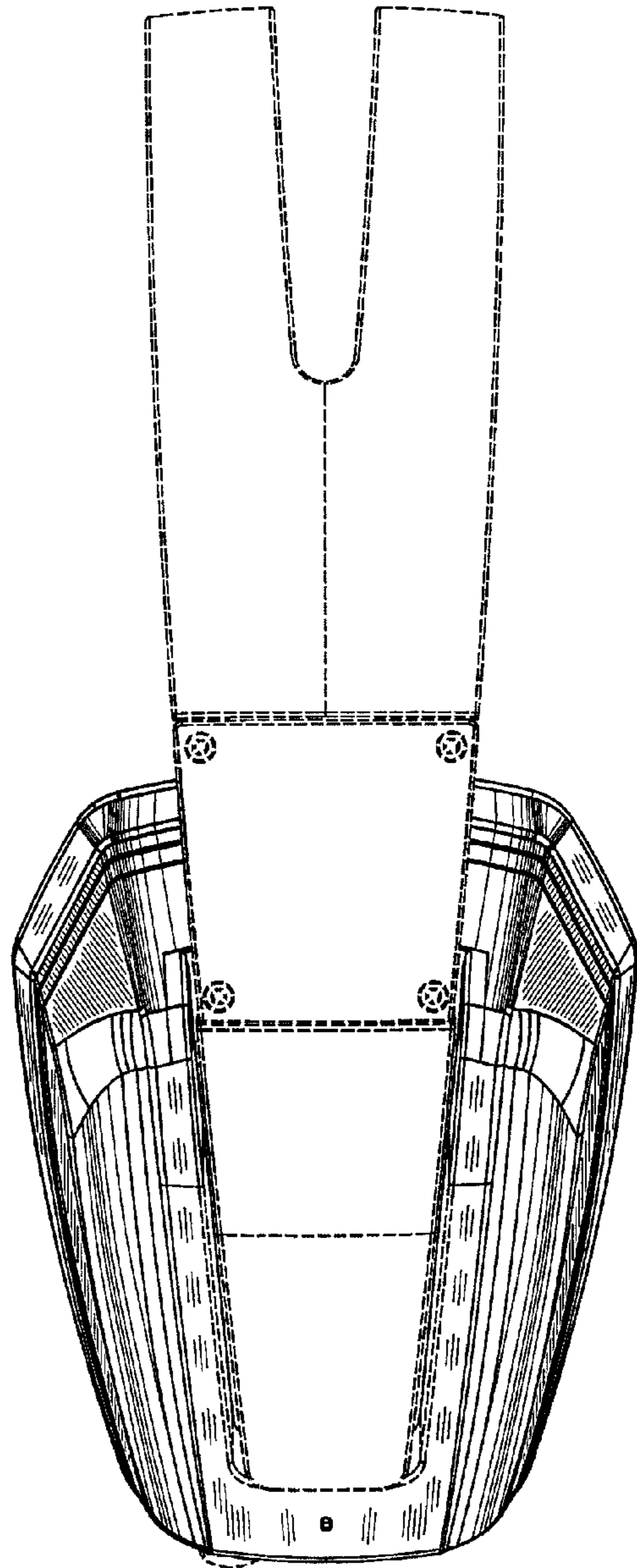

Figure 5



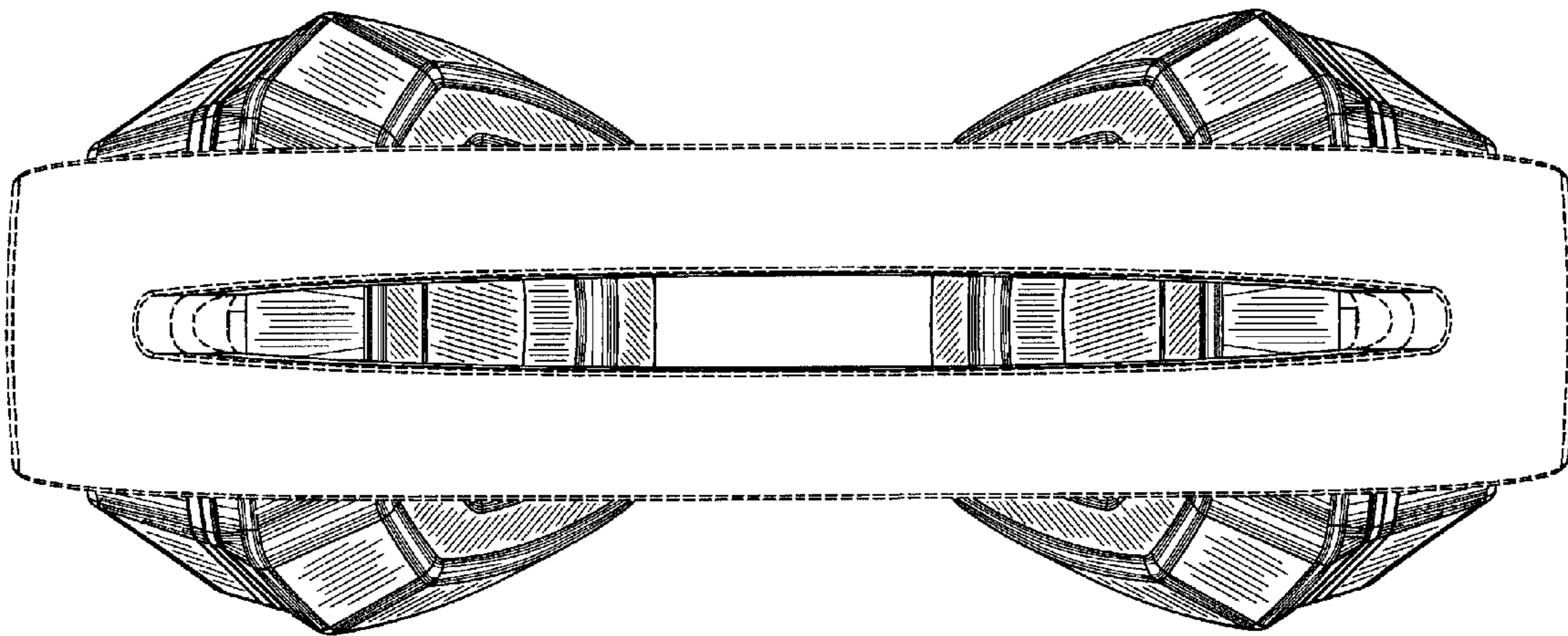

Figure 6

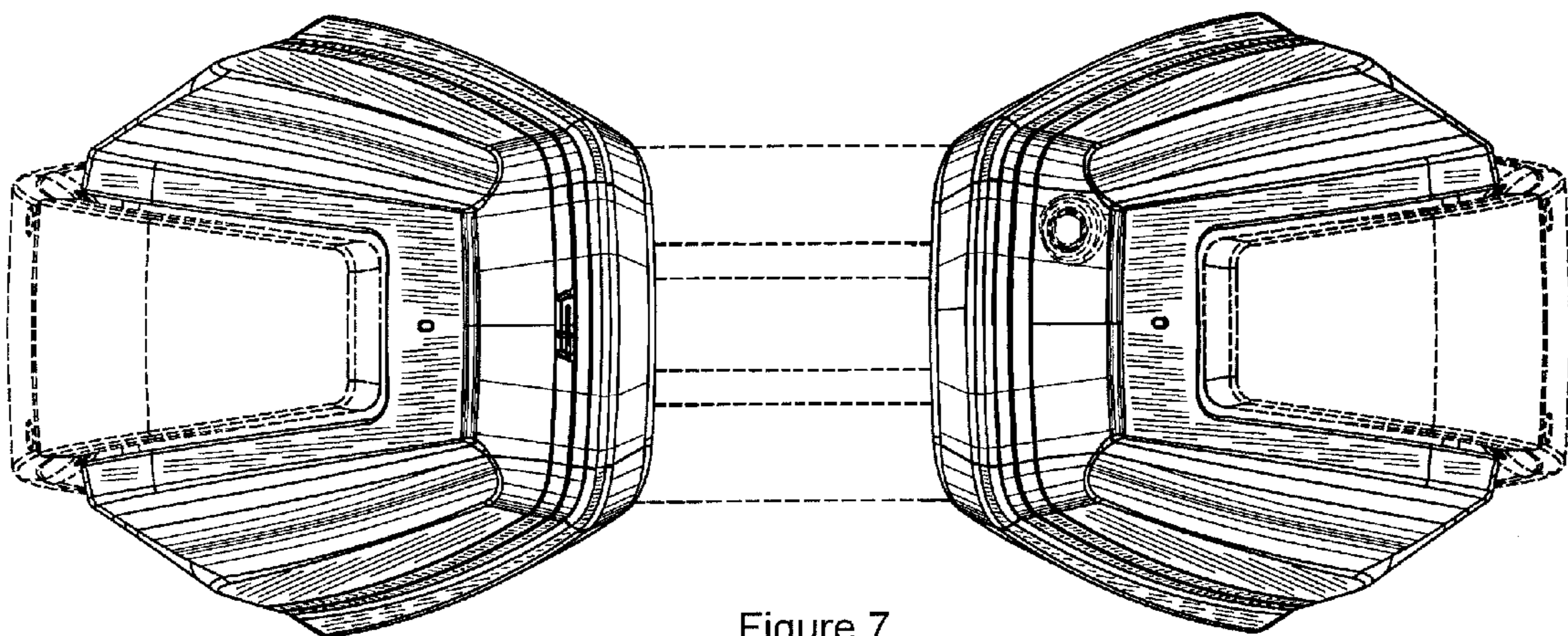

Figure 7