



US00D651431S

(12) **United States Design Patent**  
**Udagawa et al.**

(10) **Patent No.:** **US D651,431 S**  
(45) **Date of Patent:** **\*\* Jan. 3, 2012**

(54) **TABLE BASE**

(75) Inventors: **Masamichi Udagawa**, New York, NY (US); **Sigrid Moeslinger**, New York, NY (US)

(73) Assignee: **Knoll, Inc.**, East Greenville, PA (US)

(\*\*) Term: **14 Years**

(21) Appl. No.: **29/363,753**

(22) Filed: **Jun. 14, 2010**

(51) **LOC (9) Cl.** ..... **06-06**

(52) **U.S. Cl.** ..... **D6/495**

(58) **Field of Classification Search** ..... D6/480-489, D6/429-431, 495-499, 422, 423; 108/150, 108/155, 156, 157.1, 161; 248/188, 188.1, 248/188.8

See application file for complete search history.

(56) **References Cited**

**U.S. PATENT DOCUMENTS**

D216,715	S	*	3/1970	Dottinger	.....	D6/495
4,645,161	A	*	2/1987	Collins	.....	248/439
D345,476	S	*	3/1994	Burdick et al.	.....	D6/495
D354,643	S	*	1/1995	Hansel et al.	.....	D6/484
5,662,298	A	*	9/1997	Collins	.....	248/188.1
D460,639	S	*	7/2002	Crinion	.....	D6/480
D510,492	S	*	10/2005	Sakurai et al.	.....	D6/495
D526,811	S	*	8/2006	Nicoletti	.....	D6/421
D588,845	S		3/2009	Lovegrove		

**FOREIGN PATENT DOCUMENTS**

EP 1008315 A1 6/2000

\* cited by examiner

*Primary Examiner* — Janice Seeger

(74) *Attorney, Agent, or Firm* — Buchanan Ingersoll & Rooney PC

(57) **CLAIM**

The ornamental design for a table base, as shown and described.

**DESCRIPTION**

FIG. 1 is a perspective view of a table base showing our new design;  
FIG. 2 is a front elevational view thereof;  
FIG. 3 is a rear elevational view thereof;  
FIG. 4 is a right side elevational view thereof;  
FIG. 5 is a left side elevational view thereof;  
FIG. 6 is a top plan view thereof;  
FIG. 7 is a bottom plan view thereof; and,  
FIG. 8 is a perspective view to more fully illustrate the table base without a table top.

The phantom lines in FIGS. 1-7 are for illustrative purposes only to show a sample table top and form no part of the design. The tiny side by side rectangles shown in dashed lines in FIGS. 2 and 3 are for environmental purposes only and form no part of the design. In addition, the two small circles on the bottom of the table top, the two ovals on the triangular elements, and the tiny circles within the tiny squares on the bottom of the base, all shown in dashed lines in FIG. 7, are also for environmental purposes only and form no part of the design.

**1 Claim, 7 Drawing Sheets**

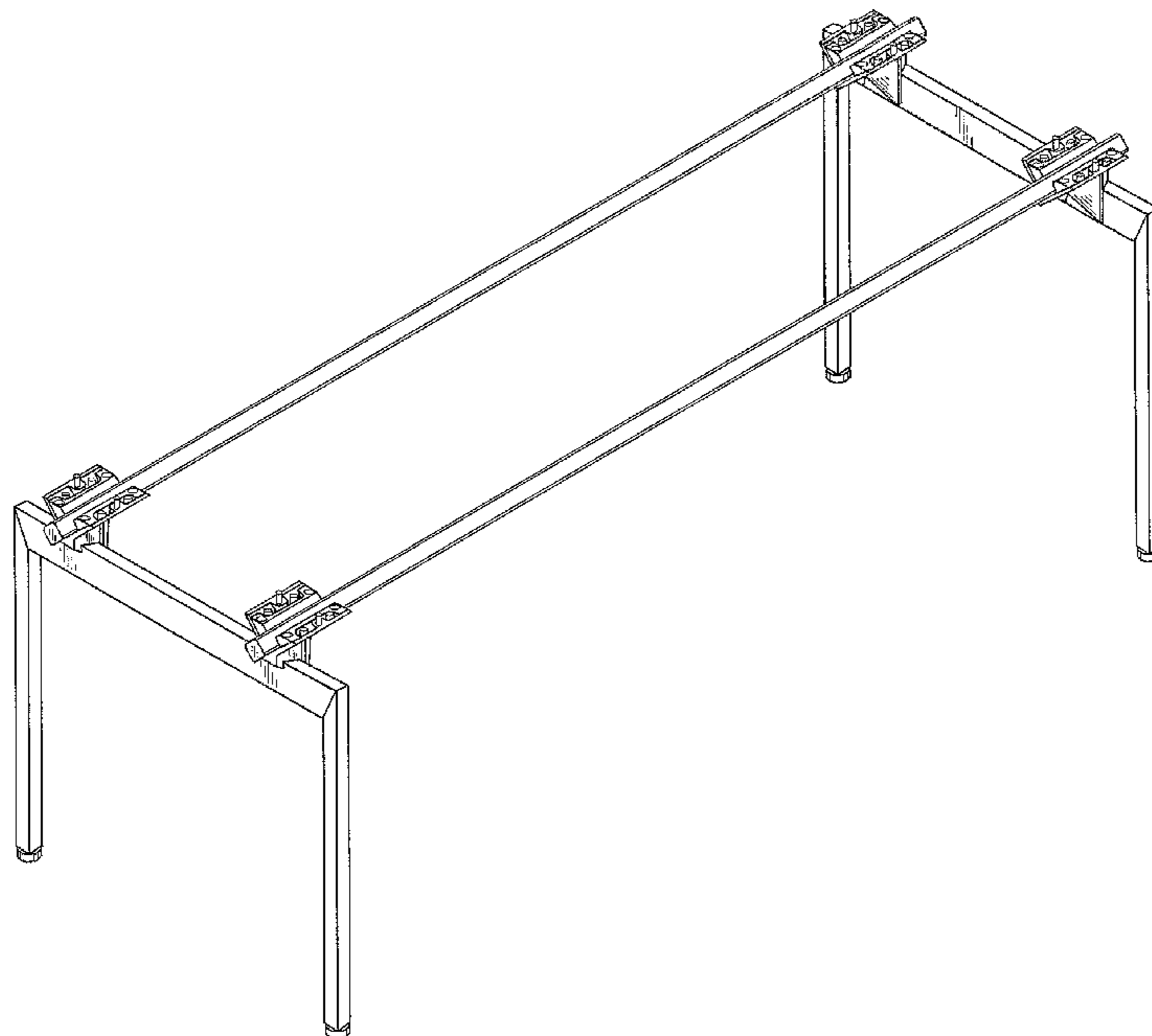

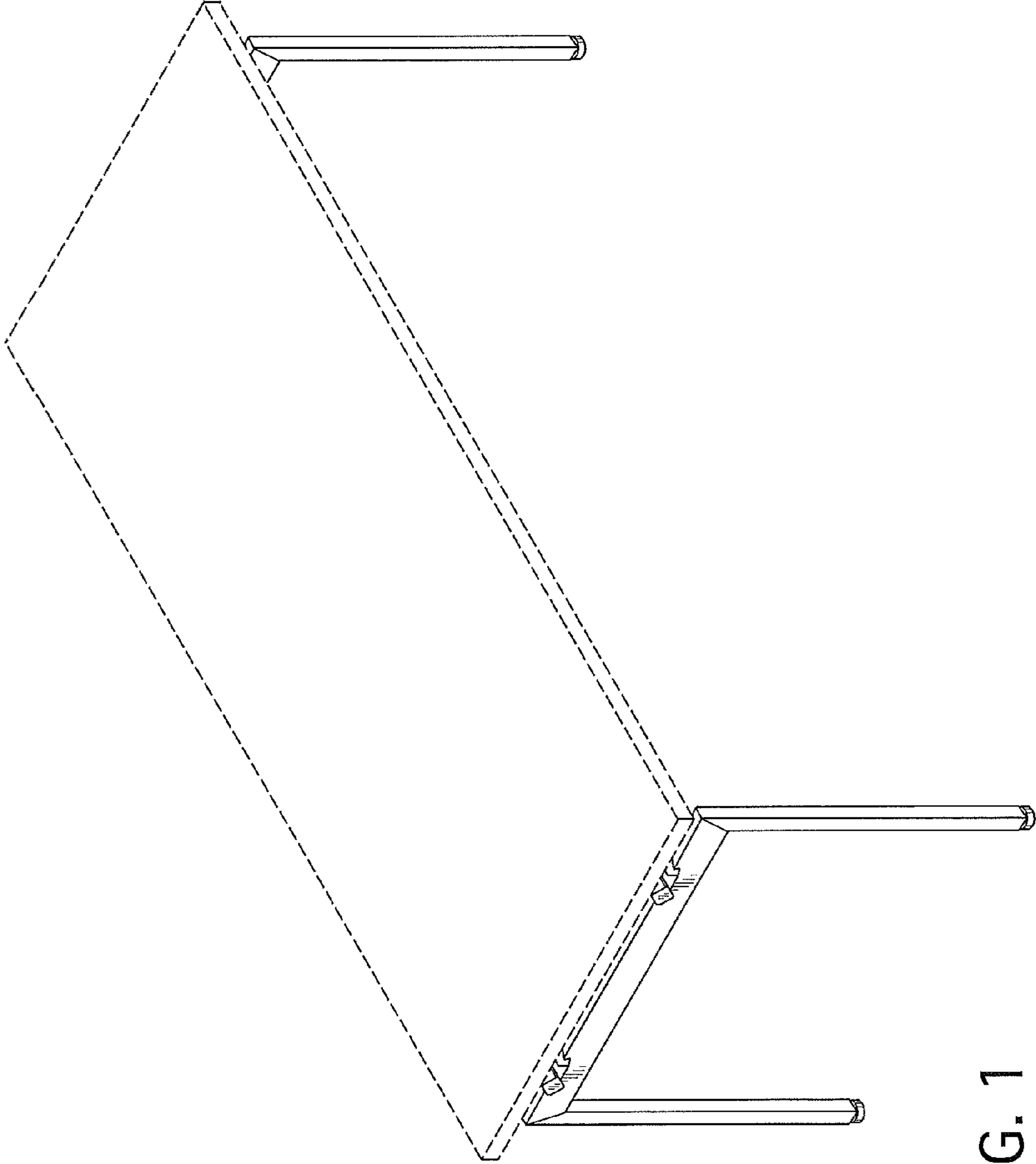

FIG. 1

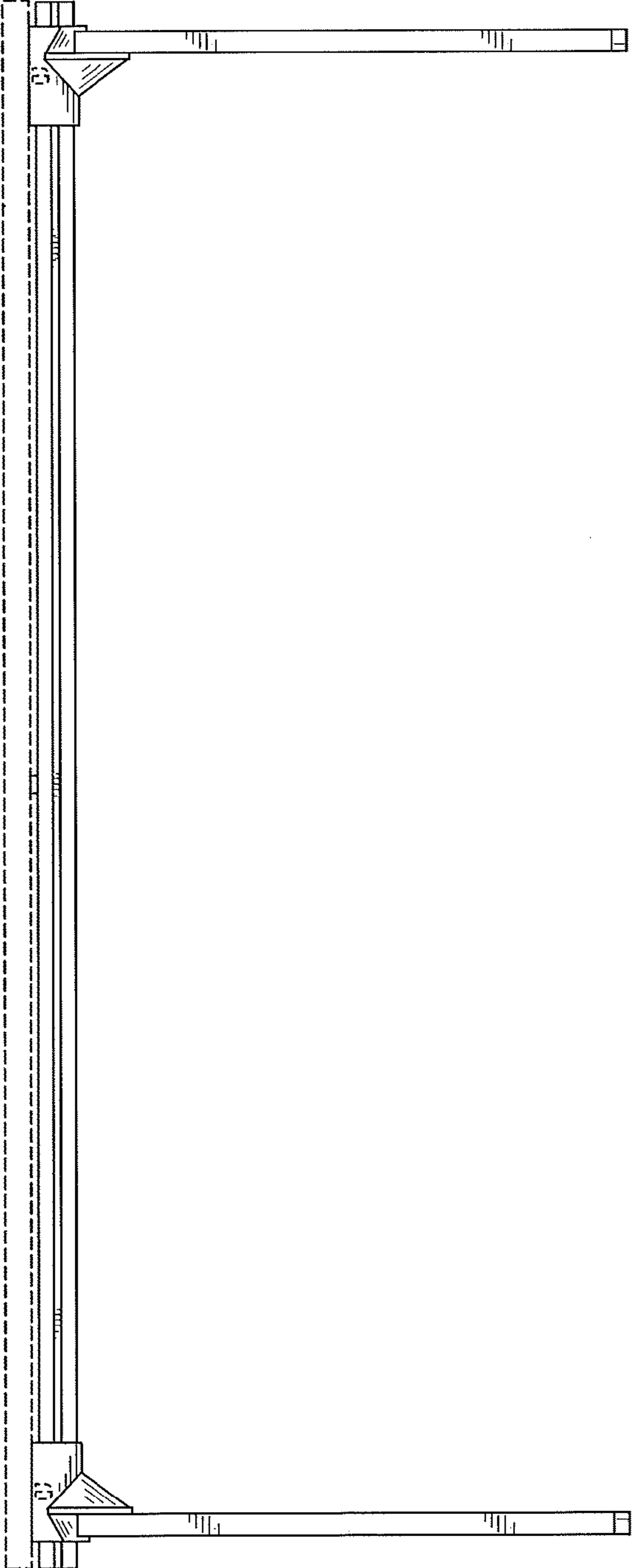

FIG. 2

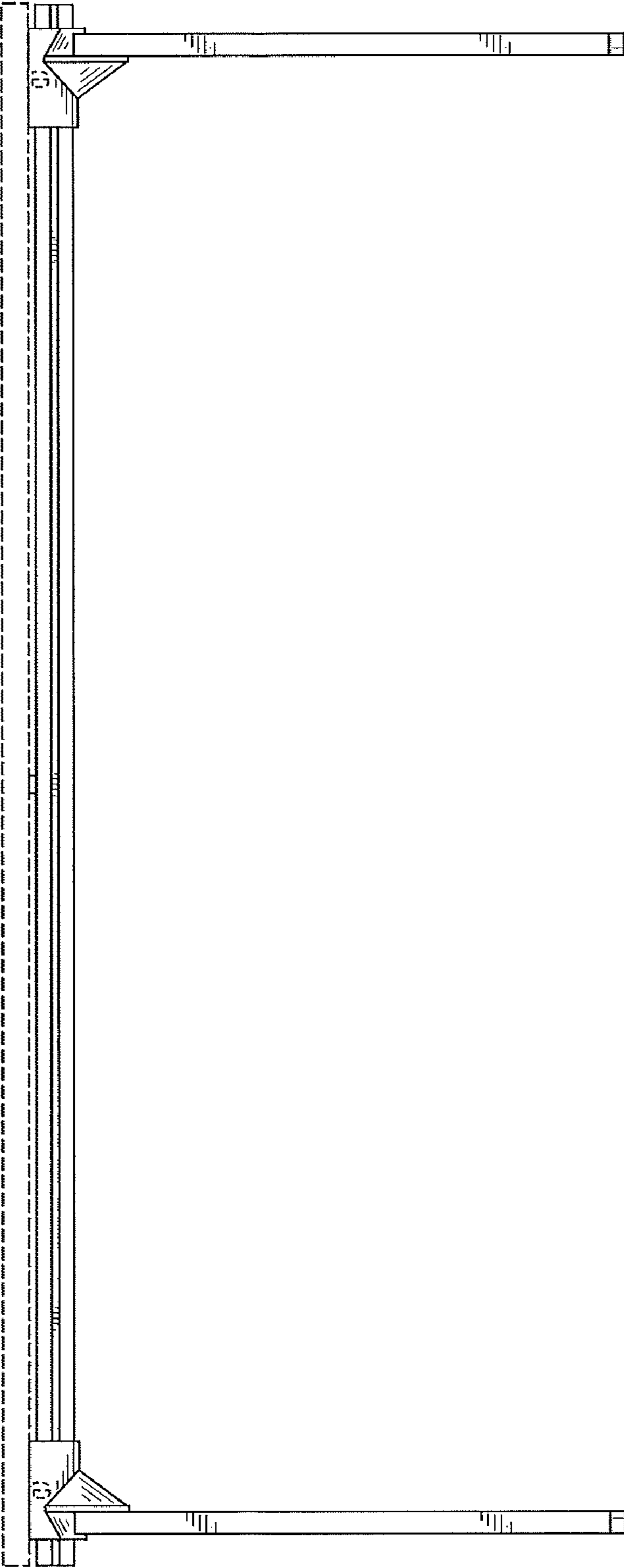

FIG. 3

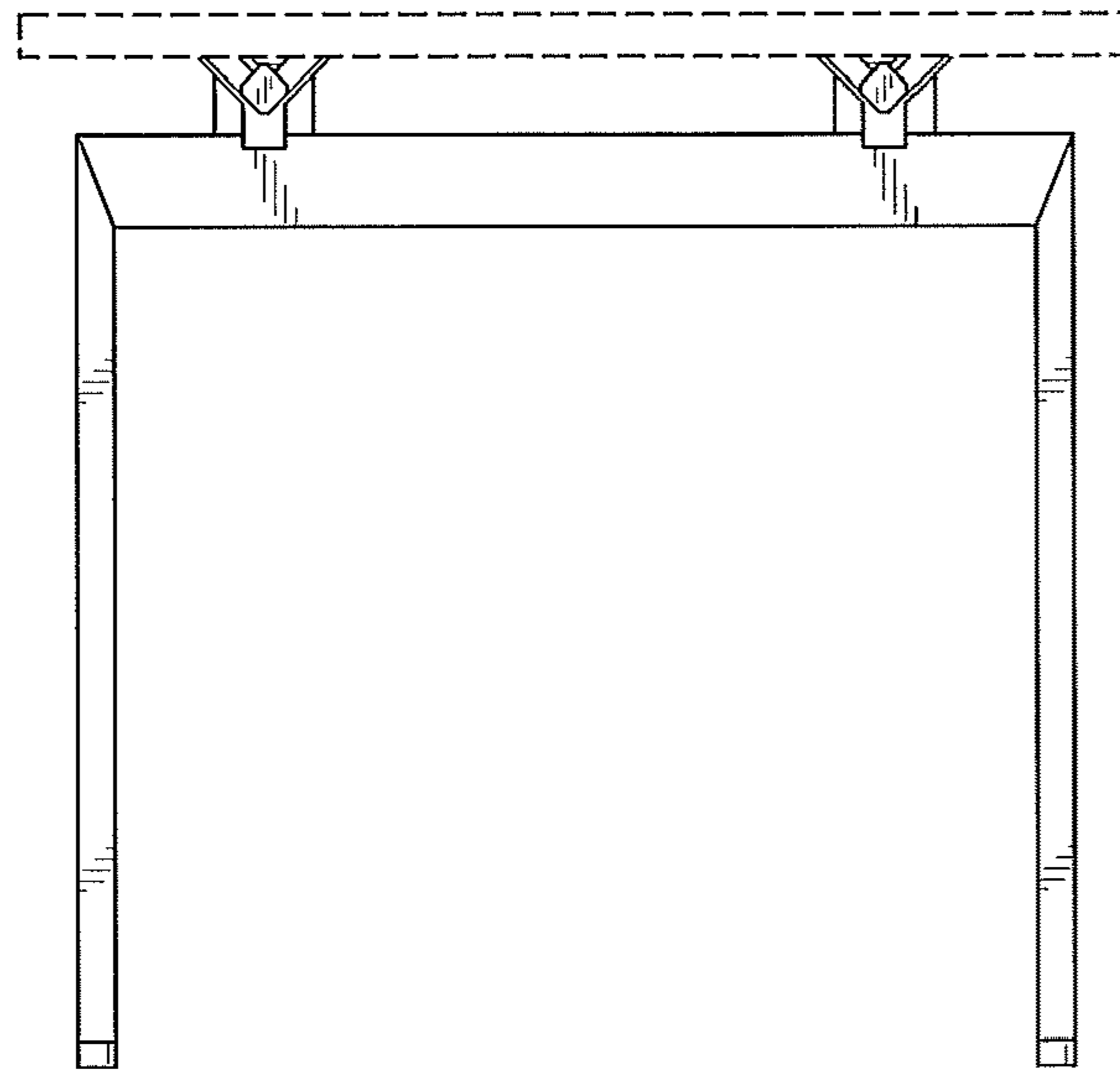

FIG. 4

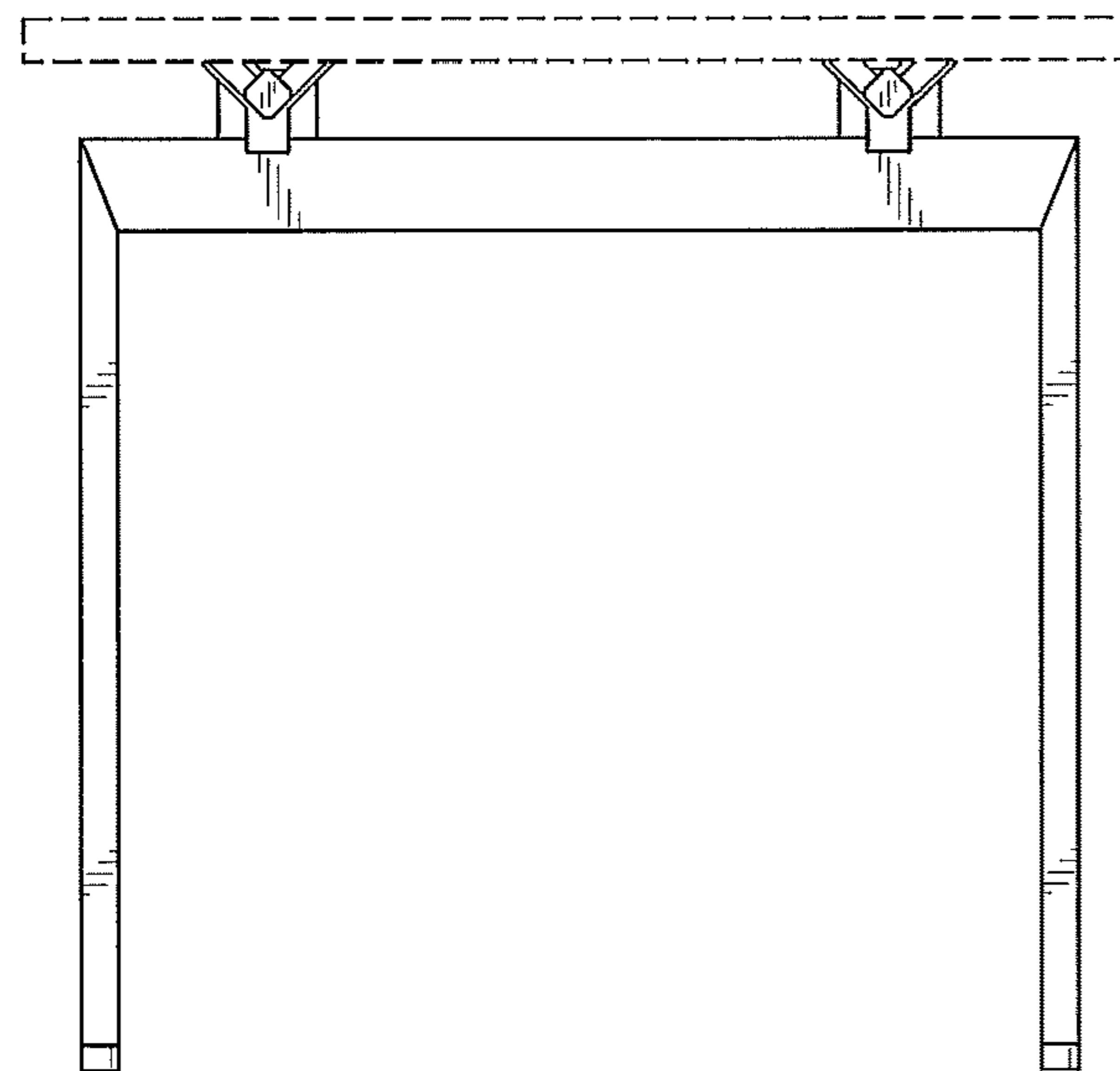

FIG. 5

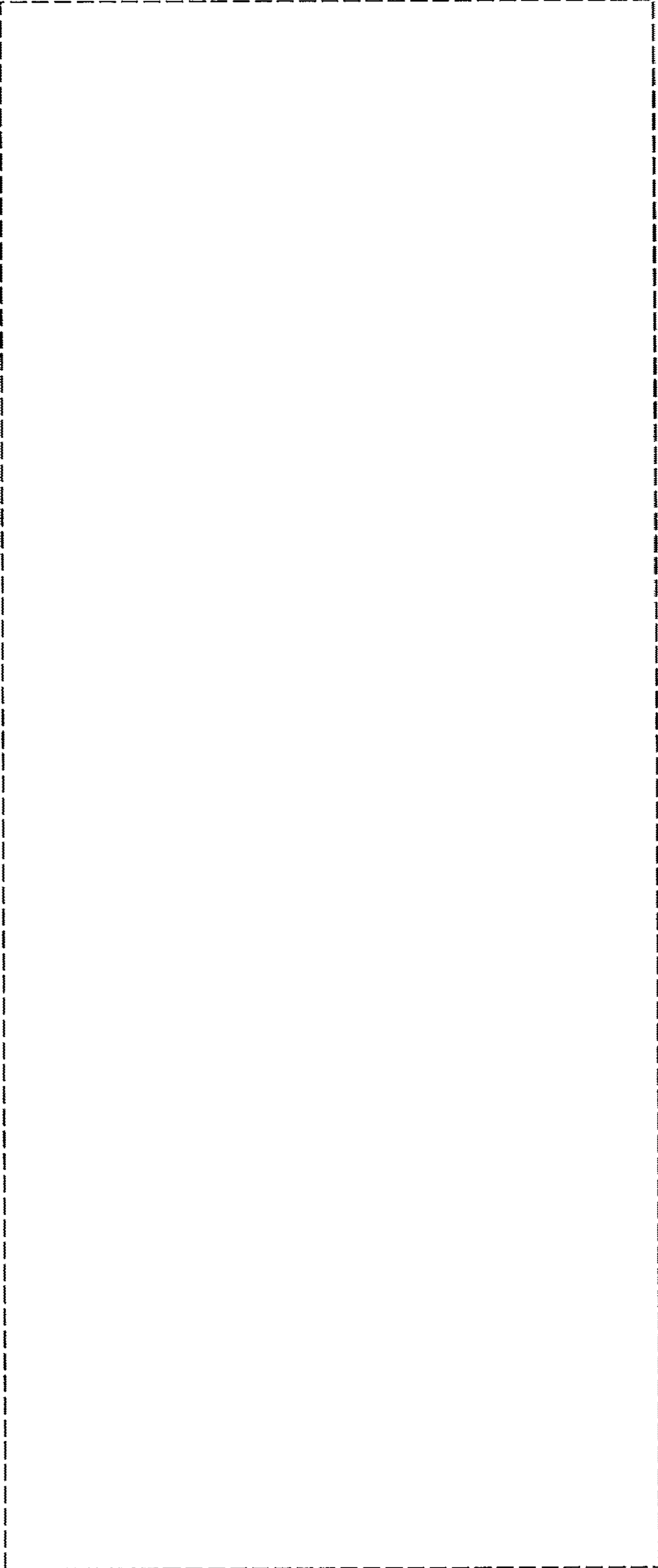

FIG. 6

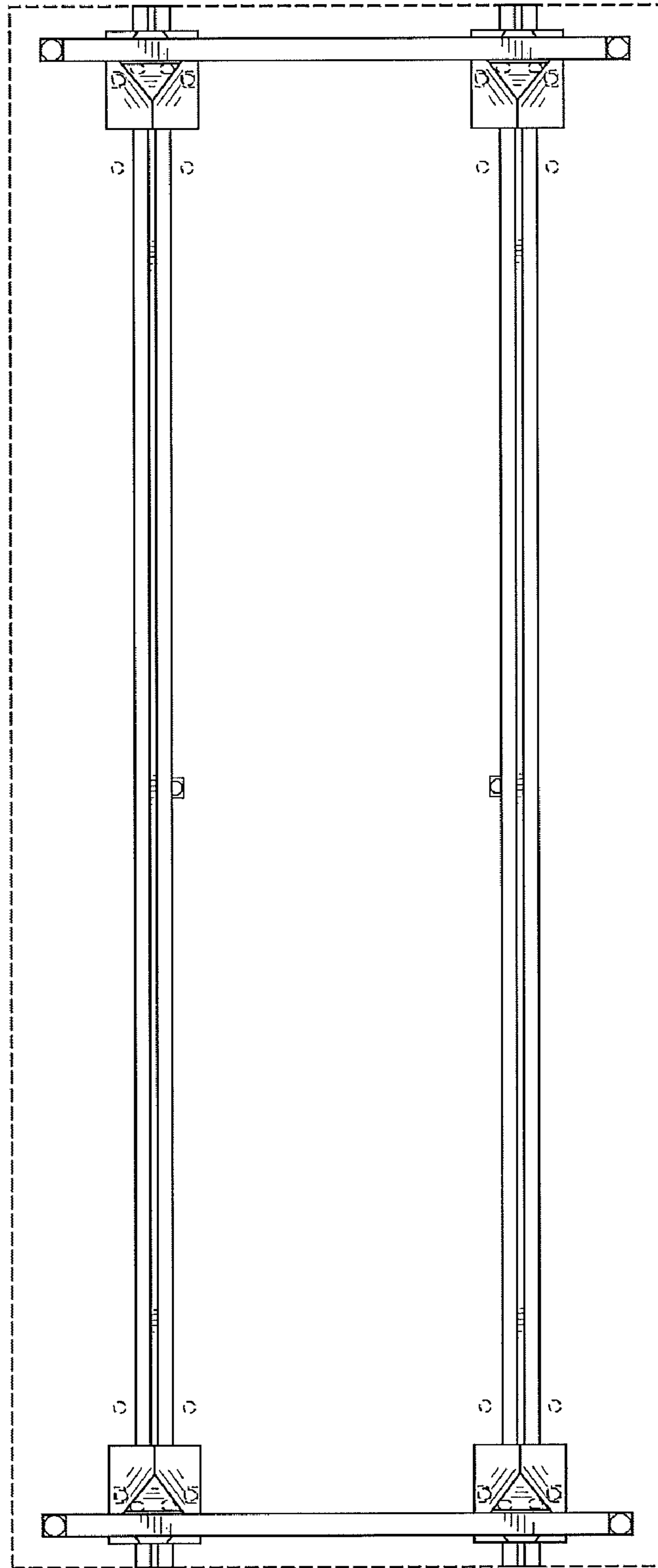

FIG. 7

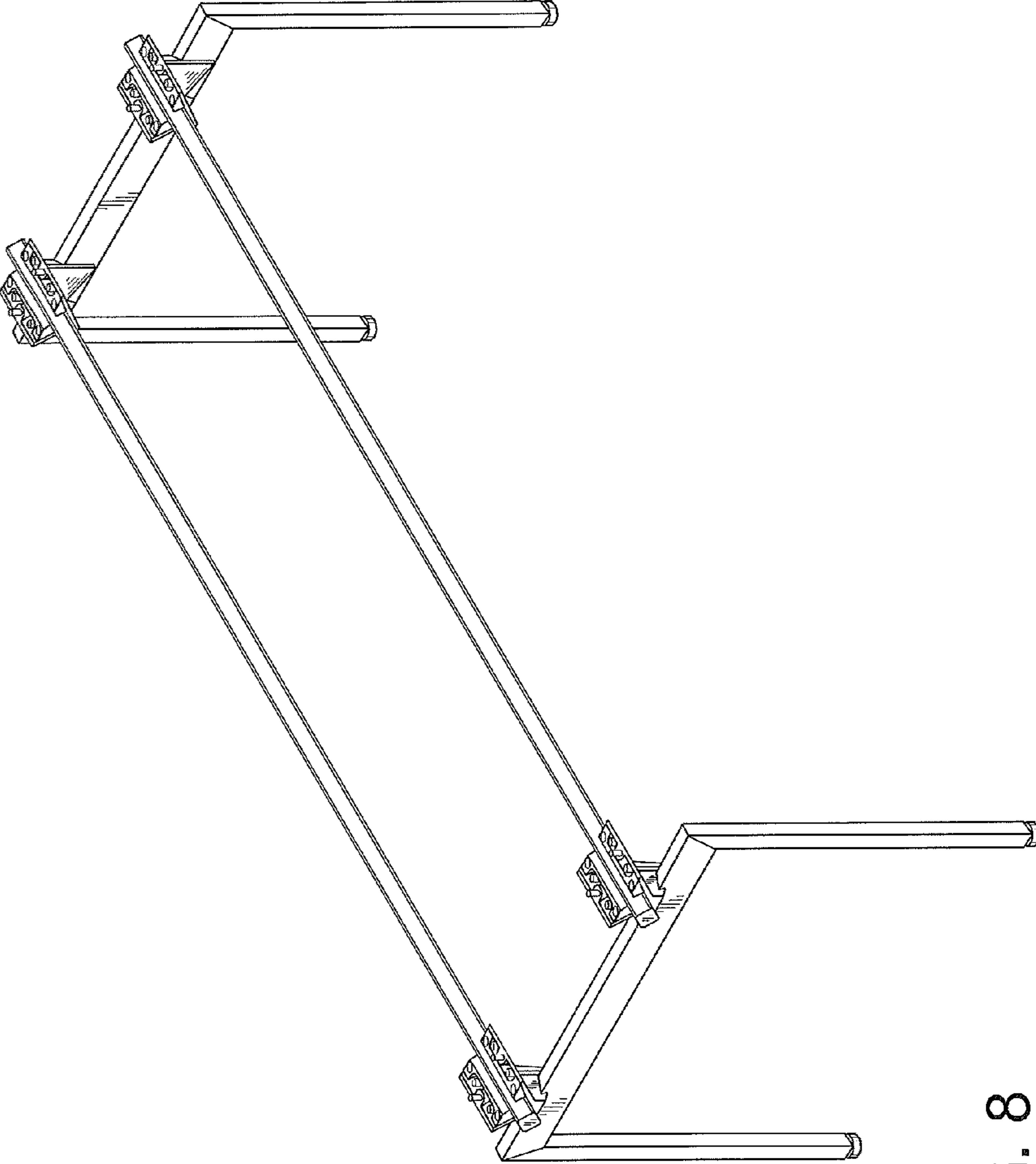

FIG. 8