



US00D651402S

(12) **United States Design Patent**  
**Borghi**

(10) **Patent No.:** **US D651,402 S**  
(45) **Date of Patent:** **\*\* Jan. 3, 2012**

(54) **HANDBAG**

(75) Inventor: **Leonello Borghi**, New York, NY (US)

(73) Assignee: **Lancel International S.A.**,  
Villars-Sur-Glane (CH)

(\*\*) Term: **14 Years**

(21) Appl. No.: **29/378,772**

(22) Filed: **Nov. 9, 2010**

(30) **Foreign Application Priority Data**

May 10, 2010 (WO) ..... DM/073.738

(51) **LOC (9) Cl.** ..... **03-01**

(52) **U.S. Cl.** ..... **D3/245**

(58) **Field of Classification Search** ..... D3/232–233,  
D3/240–246; 150/100, 103–110, 113–114,  
150/118–119

See application file for complete search history.

(56) **References Cited**

U.S. PATENT DOCUMENTS

D281,201 S \* 11/1985 Schimmel ..... D3/244  
D579,657 S \* 11/2008 Hermann ..... D3/246  
D609,903 S \* 2/2010 Brinegar ..... D3/232  
D624,751 S \* 10/2010 McLeod ..... D3/244

\* cited by examiner

*Primary Examiner* — Holly Baynham

(74) *Attorney, Agent, or Firm* — The Nath Law Group;  
Derek Richmond

(57) **CLAIM**

The ornamental design for a handbag, as shown and described.

**DESCRIPTION**

FIG. 1 is a perspective view of a handbag;  
FIG. 2 is a front view of the handbag;  
FIG. 3 is a rear view of the handbag;  
FIG. 4 is a left side view of the handbag;  
FIG. 5 is a right side view of the handbag;  
FIG. 6 is a top view of the handbag; and,  
FIG. 7 is a bottom view of the handbag.  
The broken lines representing stitching are part of the claimed design.

**1 Claim, 7 Drawing Sheets**

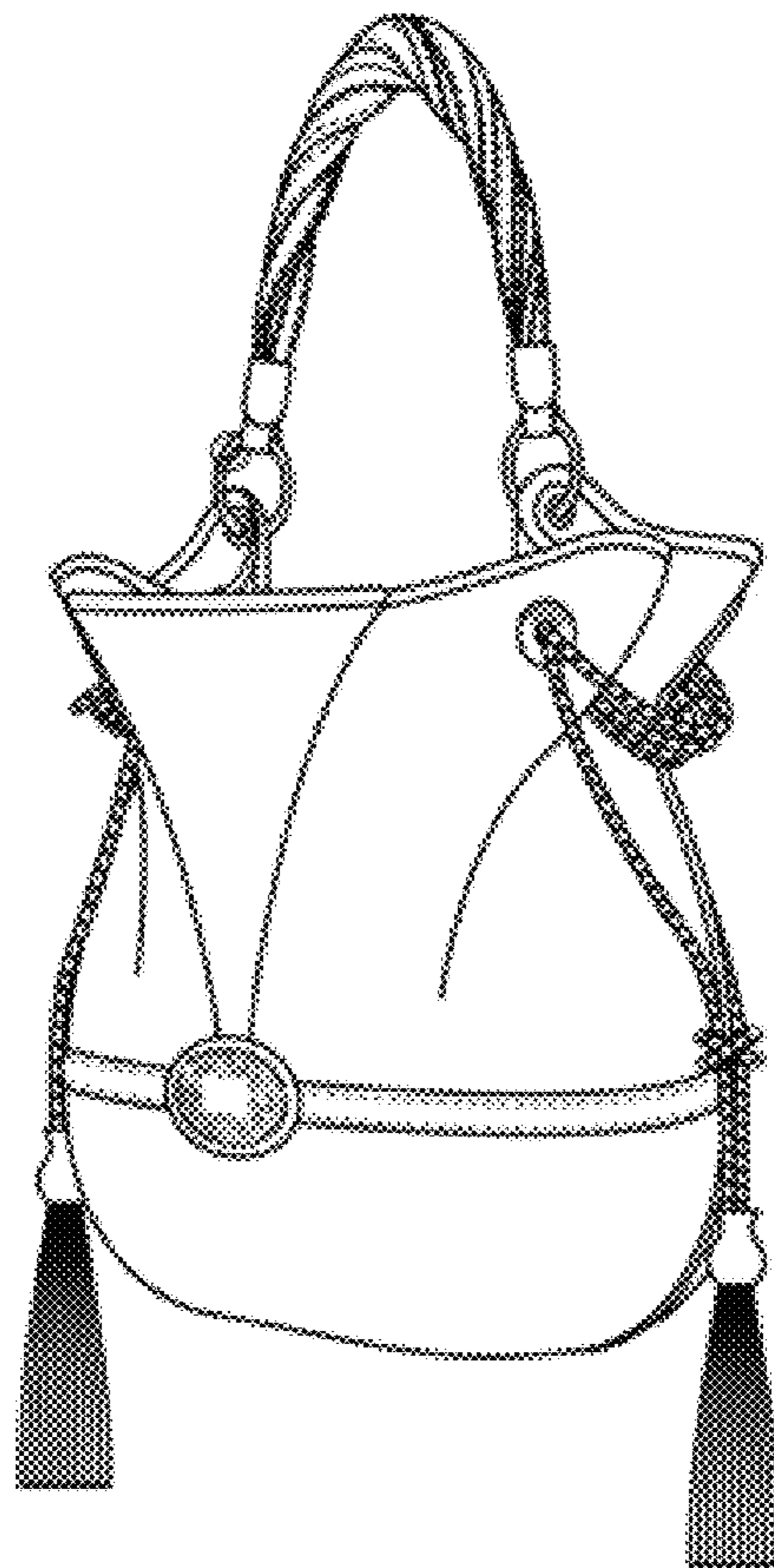

FIG. 1

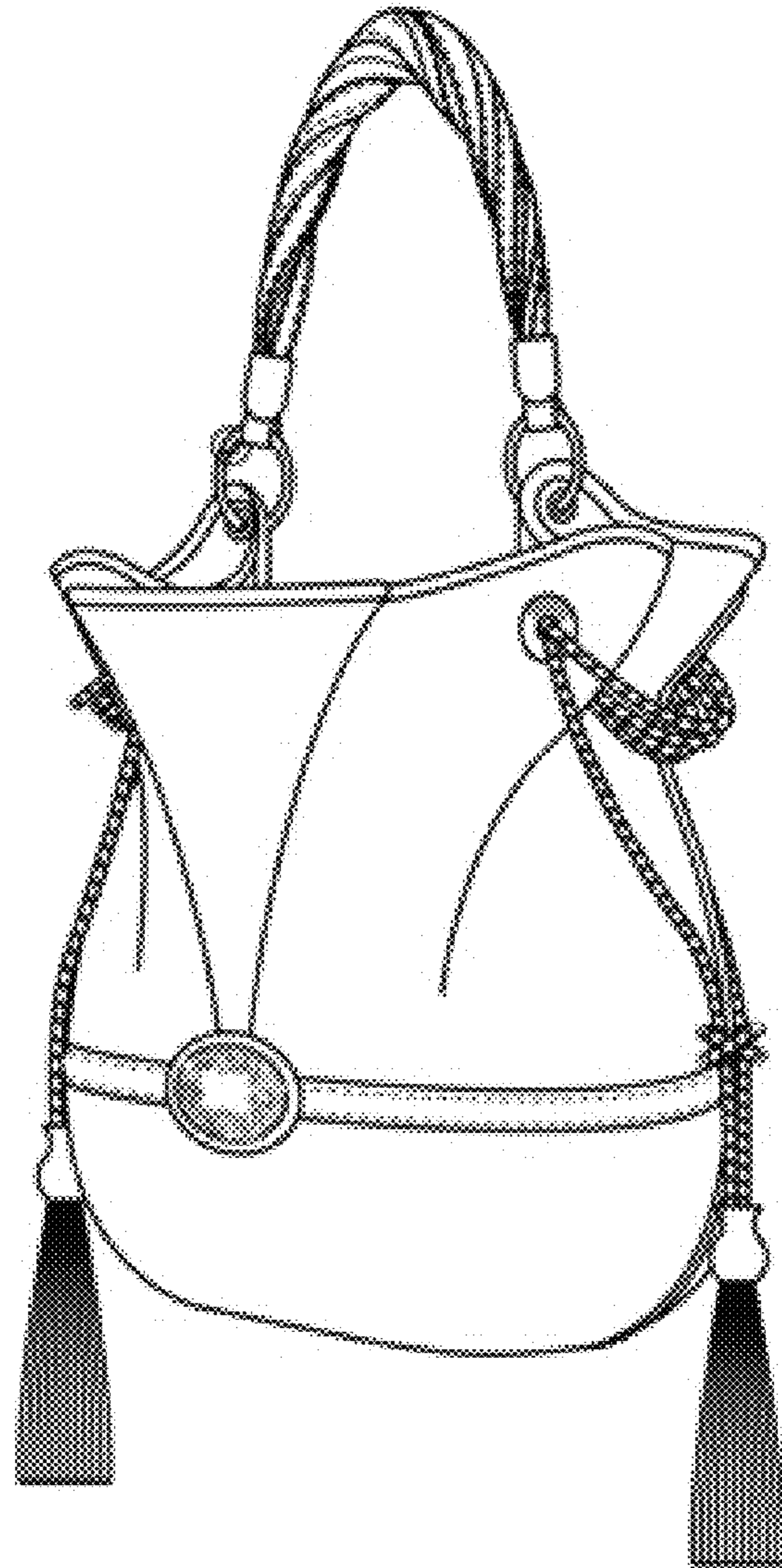

FIG. 2

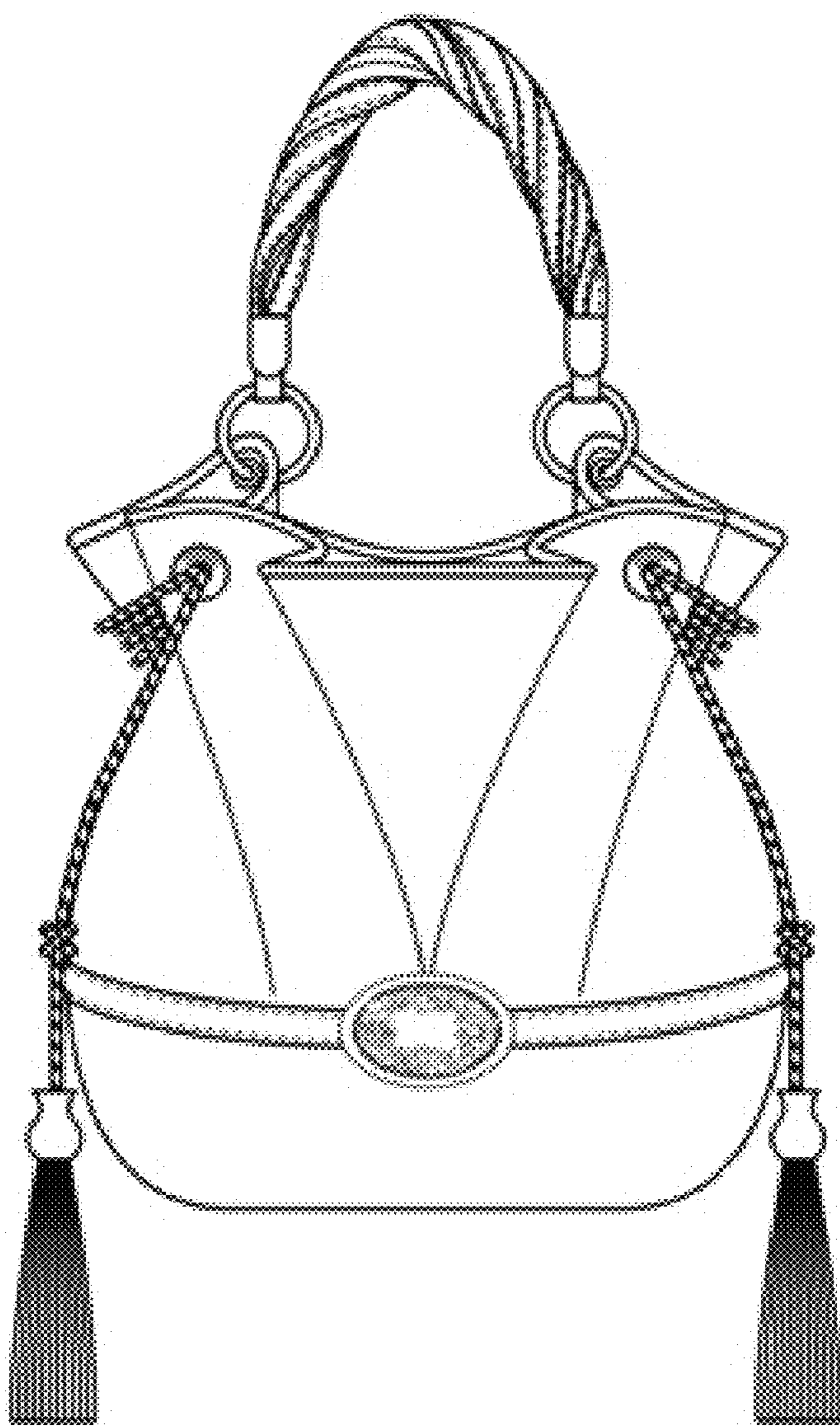



FIG. 3

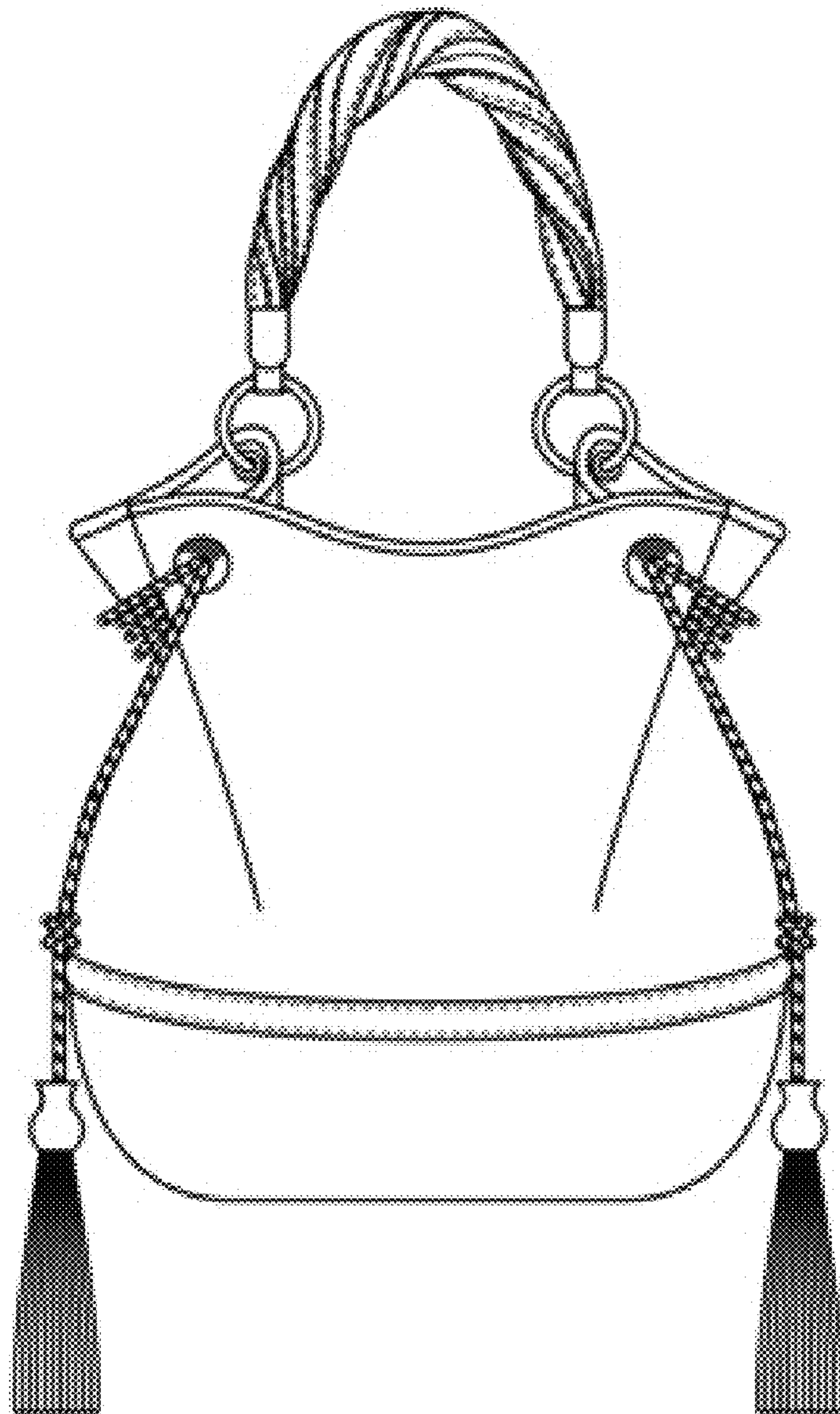

FIG. 4

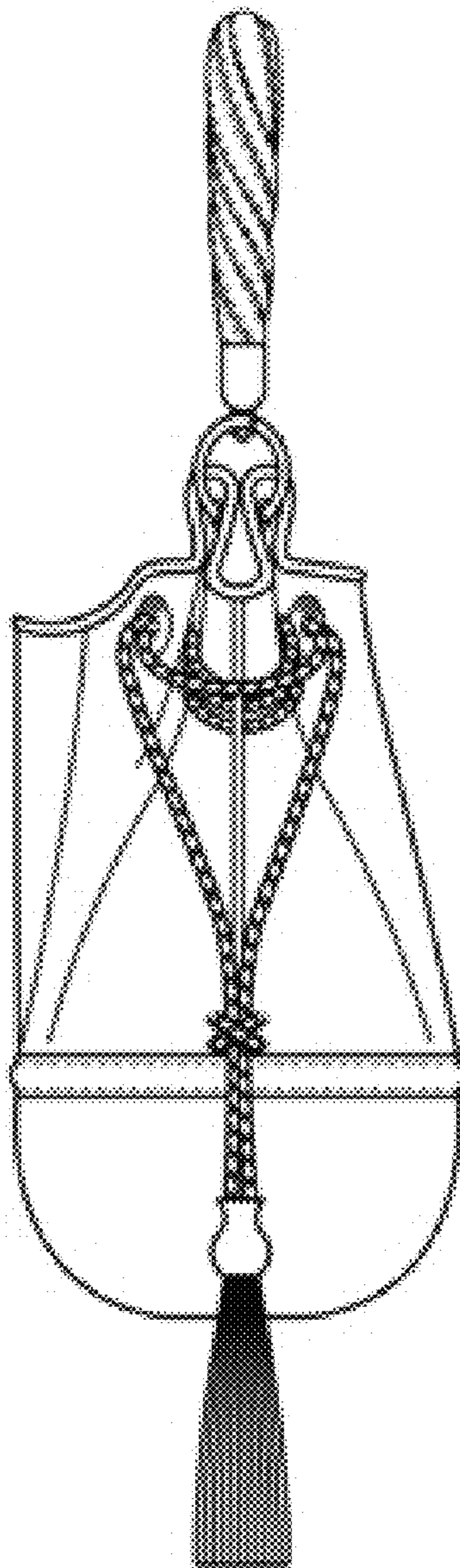

FIG. 5

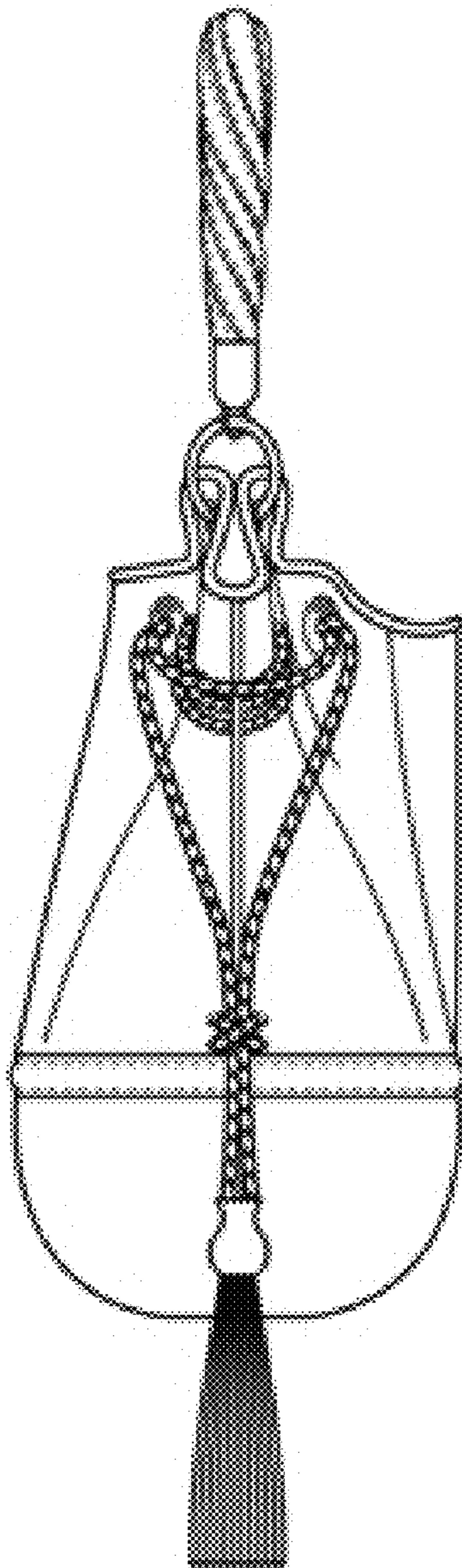

FIG. 6

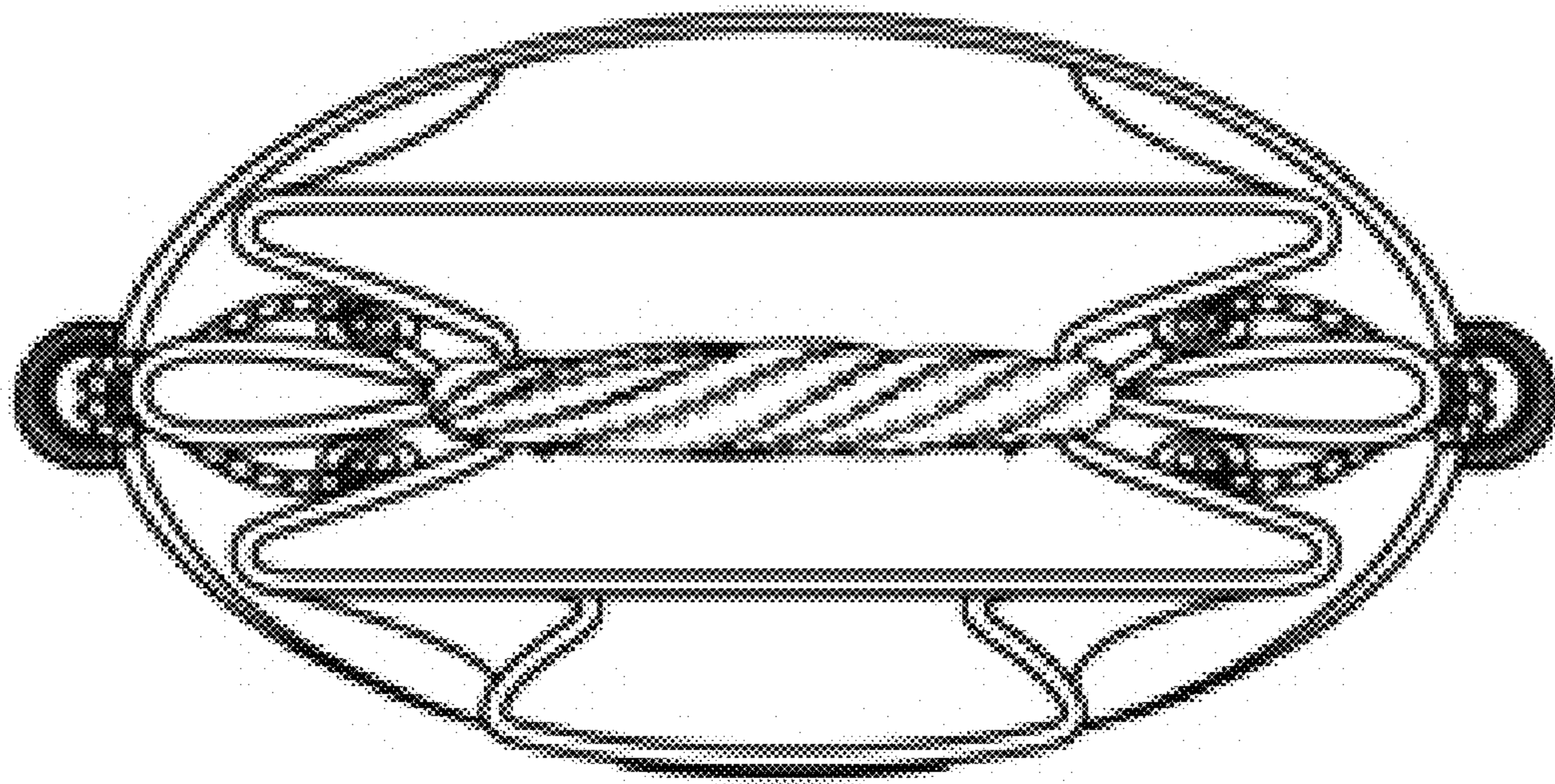



FIG. 7

