



US00D651380S

(12) **United States Design Patent**
Wilcots

(10) **Patent No.:** **US D651,380 S**
(45) **Date of Patent:** **** *Jan. 3, 2012**

(54) **ATHLETIC FOOTWEAR SECURING DEVICE**

(76) Inventor: **Cedric Wilcots**, DeSoto, TX (US)

(*) Notice: This patent is subject to a terminal disclaimer.

(**) Term: **14 Years**

(21) Appl. No.: **29/369,342**

(22) Filed: **Sep. 7, 2010**

Related U.S. Application Data

(63) Continuation-in-part of application No. 11/673,271, filed on Feb. 9, 2007, now abandoned.

(51) **LOC (9) Cl.** **02-04**

(52) **U.S. Cl.** **D2/901**

(58) **Field of Classification Search** D2/901,
D2/909-911, 913, 943, 969; 36/72 R, 70 R,
36/72 A

See application file for complete search history.

(56) **References Cited**

U.S. PATENT DOCUMENTS

D99,879	S	*	6/1936	McClure	D2/901
D278,478	S	*	4/1985	Reecher et al.	D2/901
D301,799	S	*	6/1989	Tonkel	D2/961
D385,102	S	*	10/1997	Avar	D2/972
D440,030	S	*	4/2001	Revis	D2/901

D453,062	S	*	1/2002	Hall	D2/911
D456,122	S	*	4/2002	Hall	D2/911
7,383,646	B2	*	6/2008	Hall	36/7.1 R
D599,981	S	*	9/2009	Kim	D2/901
D619,338	S	*	7/2010	Teichert et al.	D2/901
D620,236	S	*	7/2010	Langley et al.	D2/901
2006/0075661	A1	*	4/2006	Ramsey	36/89
2007/0186449	A1	*	8/2007	Wilcots	36/2 R

* cited by examiner

Primary Examiner — Stella Reid

Assistant Examiner — Keli L Hill

(74) *Attorney, Agent, or Firm* — Jonathan E. Szarzynski; Szarzynski PLLC

(57) **CLAIM**

I claim the ornamental design for an athletic footwear securing device, as shown.

DESCRIPTION

FIG. 1 is a bottom, rear and right side perspective view of and athletic footwear securing device, embodying my new design;

FIG. 2 is a rear elevational view thereof;

FIG. 3 is a front elevational view thereof;

FIG. 4 is a top plan view thereof;

FIG. 5 is a left side elevational view thereof; and,

FIG. 6 is a bottom plan view thereof.

The broken line showing of leg and shoe are included for the purpose of illustrating environment of the article and forms no part of the claimed design.

1 Claim, 6 Drawing Sheets

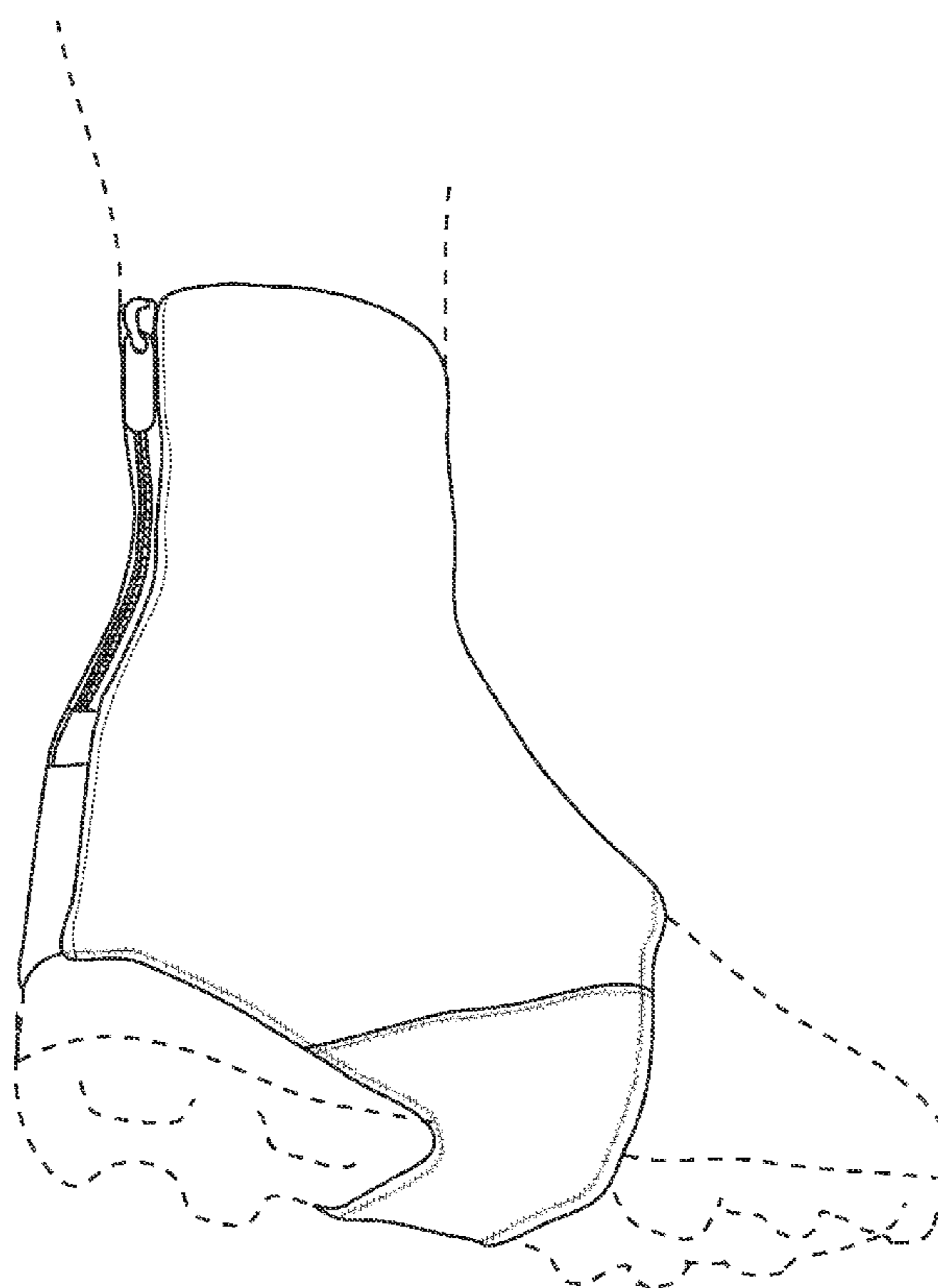

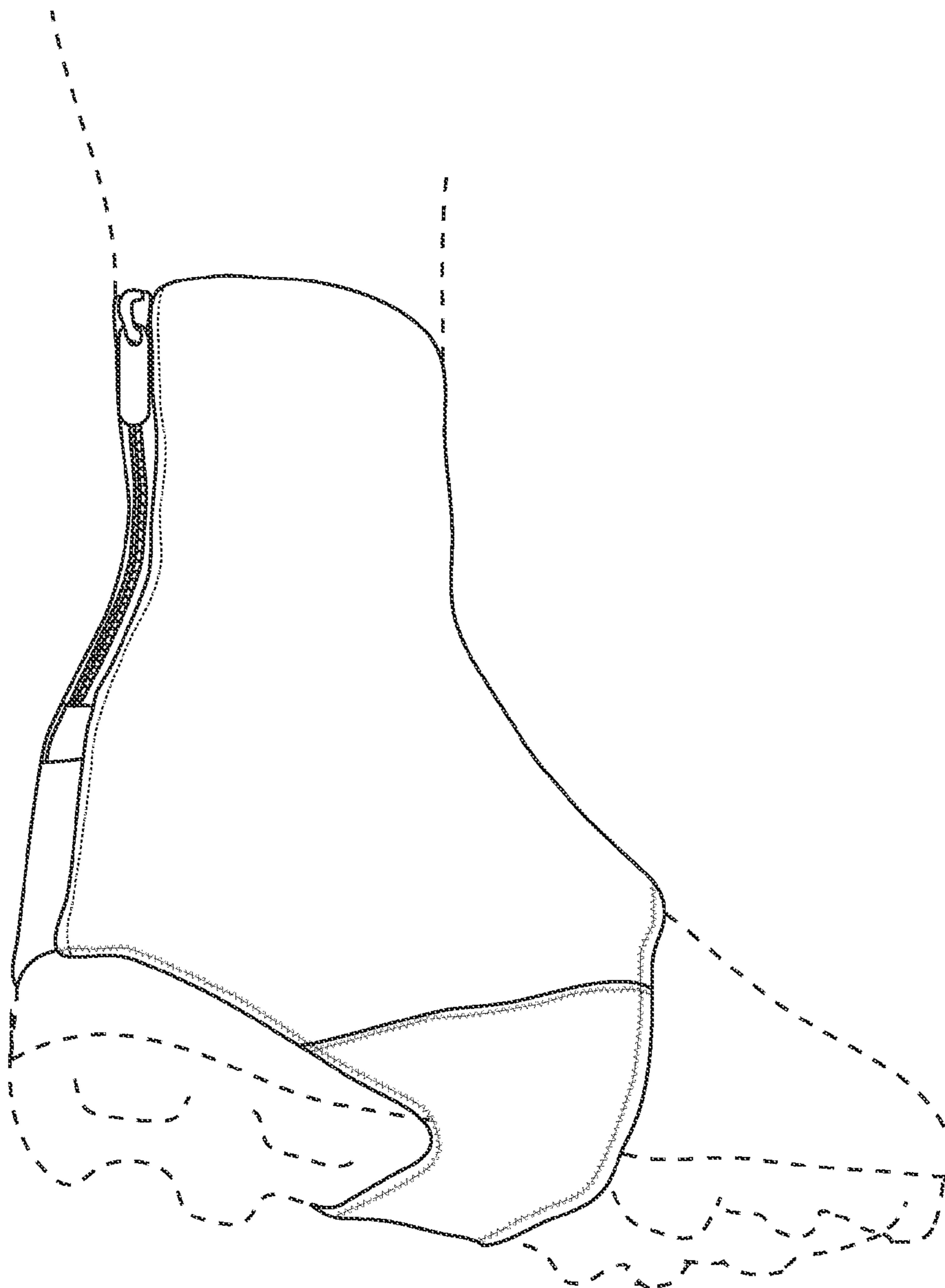

Fig. 1

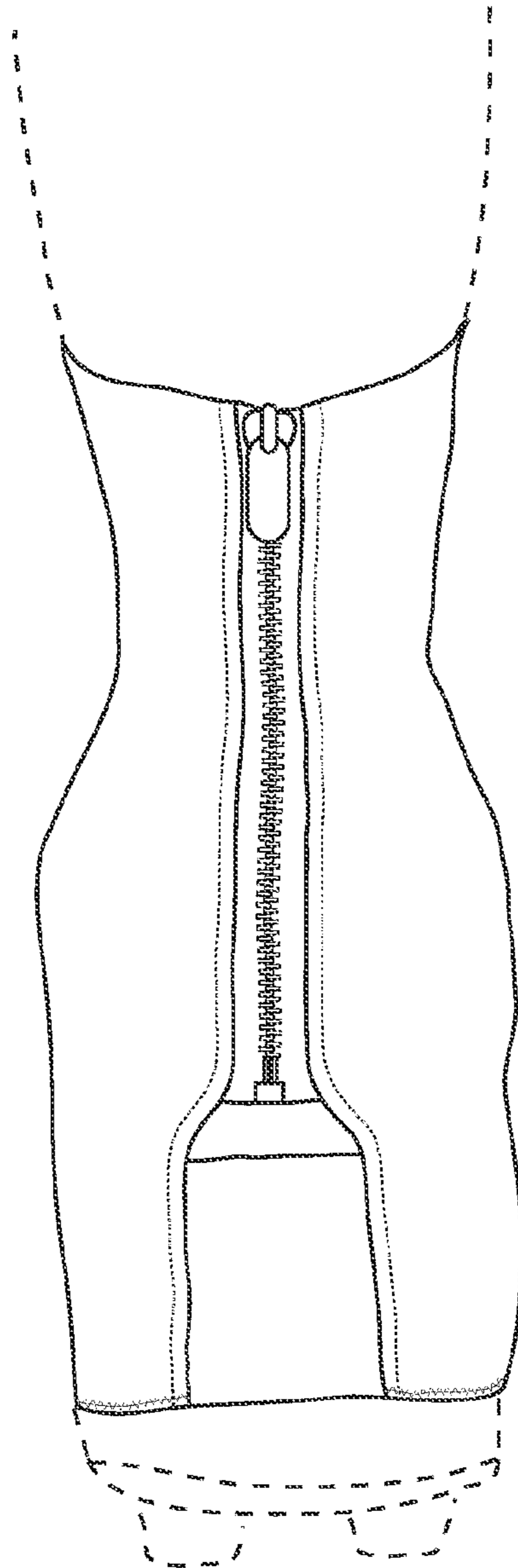

Fig. 2

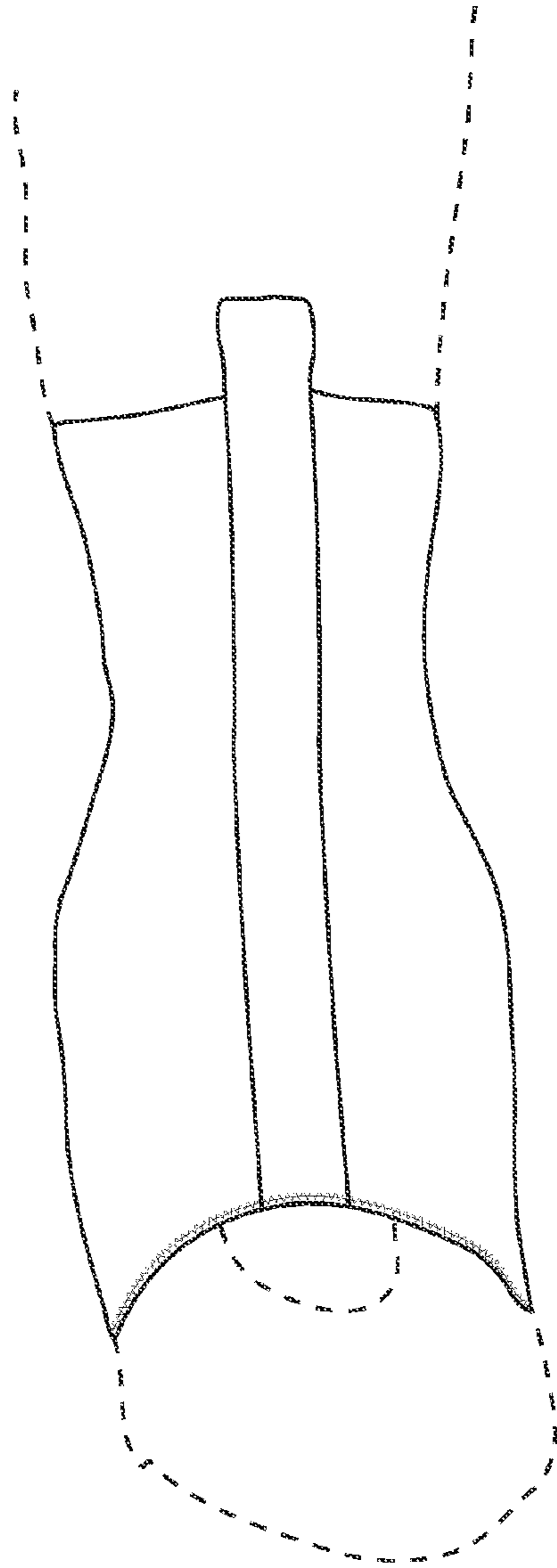

Fig. 3

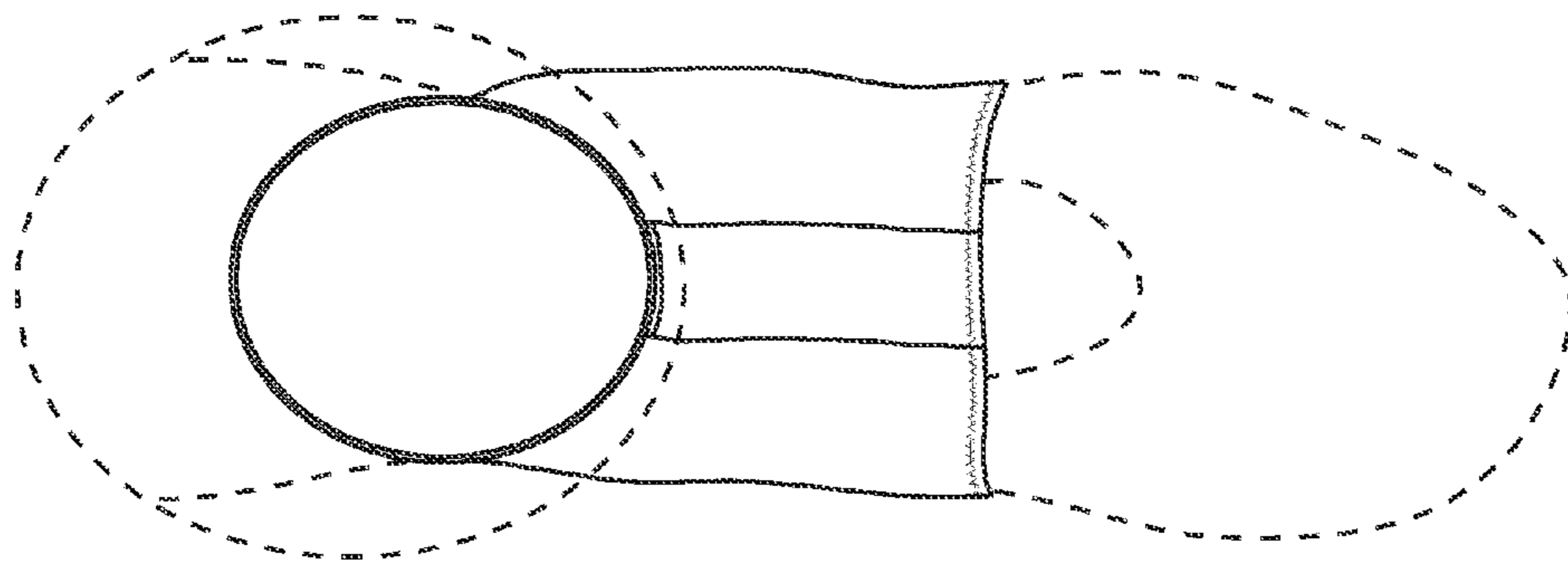

Fig. 4

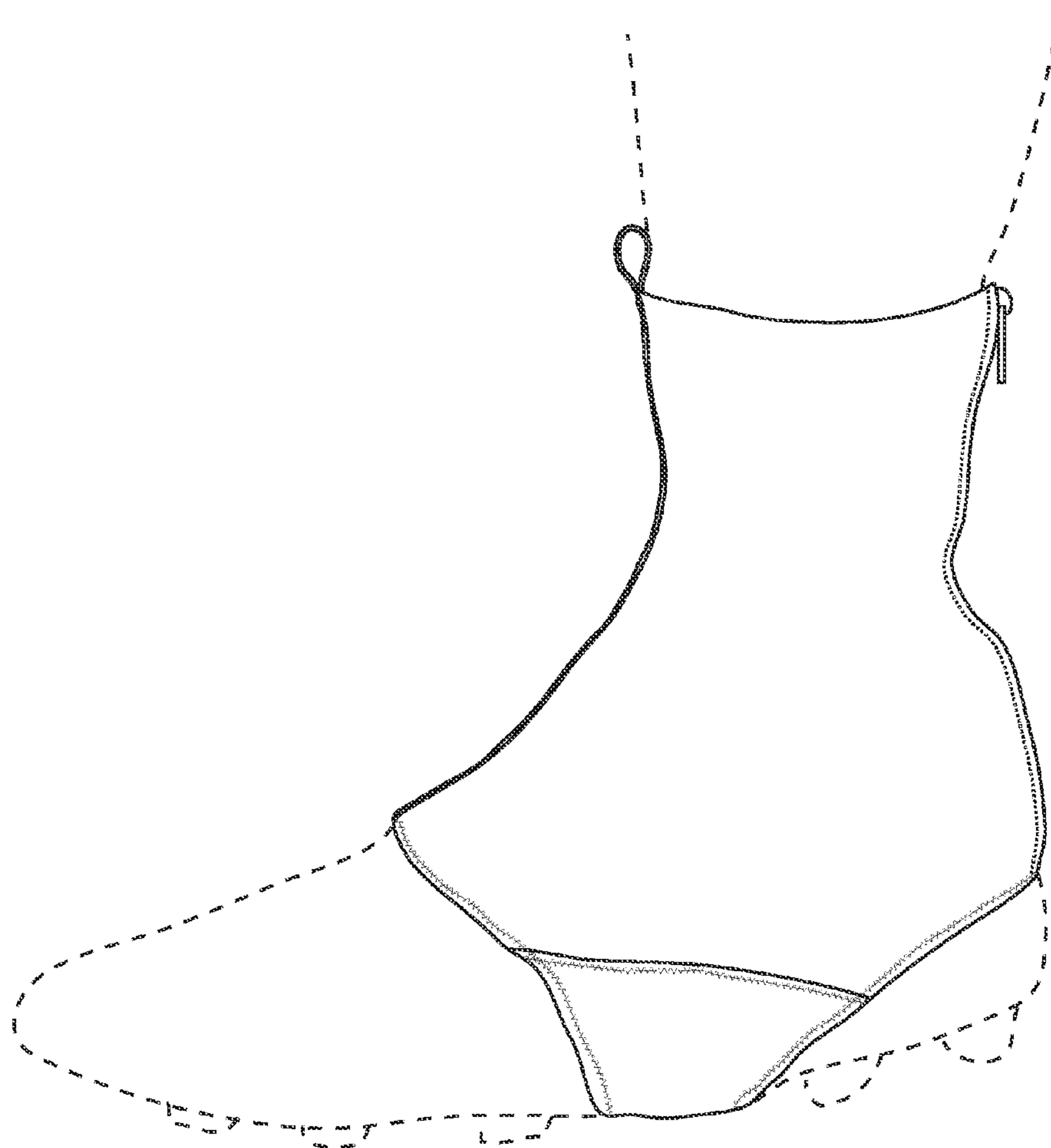

Fig. 5

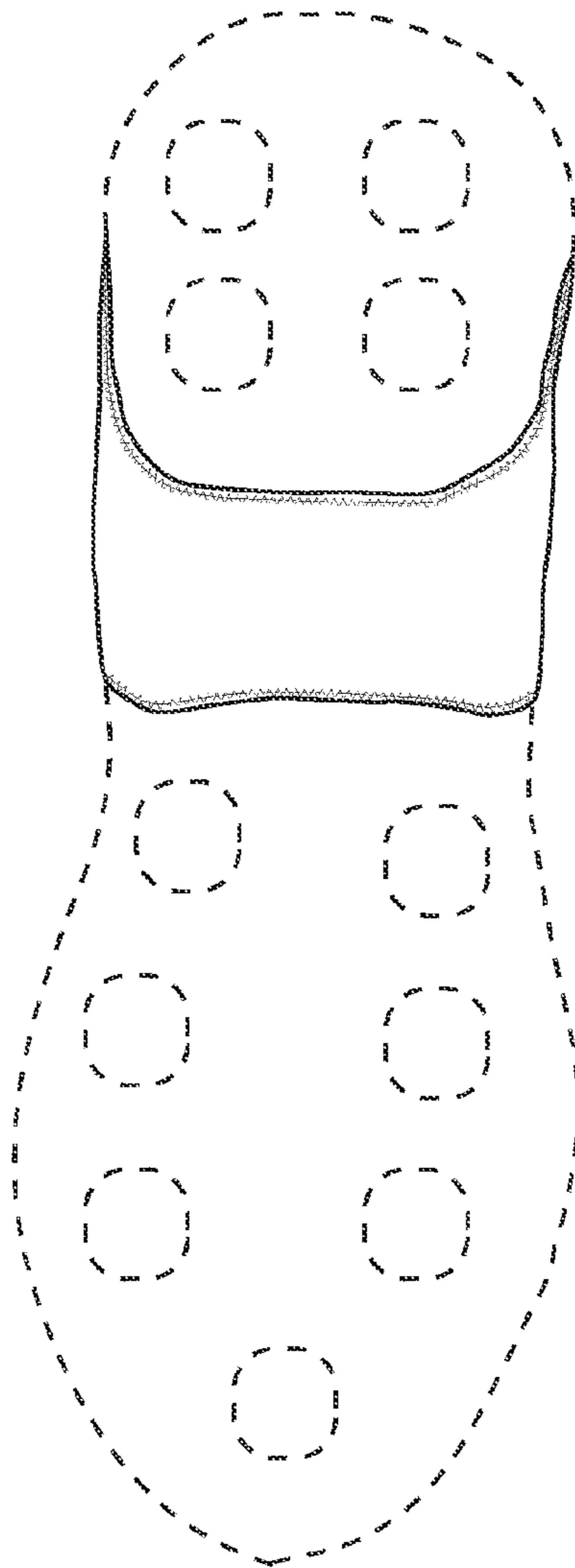

Fig. 6