



US00D651279S

(12) **United States Design Patent**  
**Wilson**

(10) **Patent No.:** **US D651,279 S**

(45) **Date of Patent:** **\*\* Dec. 27, 2011**

(54) **PORTABLE WATER PURIFICATION AND DISPENSING SYSTEM**

D596,701 S \* 7/2009 Ferreira et al. .... D23/207  
D608,130 S \* 1/2010 Moon et al. .... D7/306  
D614,727 S \* 4/2010 Therkelsen et al. .... D23/207

(75) Inventor: **Paul S. Wilson**, Surrey (CA)

**OTHER PUBLICATIONS**

(73) Assignee: **SafeStar Products Company Limited**,  
Vancouver (CA)

WaterFillz Special Events Portable Kiosk designed by Paul S. Wilson, used by SafeStar Products Company Limited in Langley, British Columbia, Canada, Jul. 23, 2010.

(\*\*) Term: **14 Years**

\* cited by examiner

(21) Appl. No.: **29/369,263**

*Primary Examiner* — Robin V Webster

(22) Filed: **Sep. 3, 2010**

(74) *Attorney, Agent, or Firm* — Oyen Wiggs Green & Mutala LLP

(51) **LOC (9) Cl.** ..... **23-01**

(52) **U.S. Cl.** ..... **D23/207; D7/306**

(58) **Field of Classification Search** ..... D23/207,  
D23/209; D7/306–308; 210/241, 435, 85;  
222/185.1, 189.06, 189.08

(57) **CLAIM**

The ornamental design for a portable water purification and dispensing system, as shown and described.

See application file for complete search history.

**DESCRIPTION**

(56) **References Cited**

FIG. 1 is a front perspective view of a portable water purification and dispensing system showing my design;  
FIG. 2 is a rear perspective view thereof;  
FIG. 3 is a front view thereof;  
FIG. 4 is a rear view thereof;  
FIG. 5 is a right side view thereof;  
FIG. 6 is a left side view thereof;  
FIG. 7 is a top view thereof; and,  
FIG. 8 is a bottom view thereof.  
The portions of the drawing shown in stippled lines do not form part of the design.

**U.S. PATENT DOCUMENTS**

D290,330 S *	6/1987	Lagace	.....	D7/306
D313,642 S *	1/1991	Carrano et al.	.....	D23/207
D325,767 S *	4/1992	Ostlund	.....	D23/207
5,108,590 A *	4/1992	DiSanto	.....	210/97
D340,967 S *	11/1993	Muir	.....	D23/207
D360,801 S *	8/1995	Shub	.....	D7/300
D364,771 S *	12/1995	DiSanto	.....	D7/307
D367,797 S *	3/1996	Hauser et al.	.....	D7/307
D385,746 S *	11/1997	Fritz	.....	D7/307
D402,498 S *	12/1998	Howard et al.	.....	D7/306
D440,255 S *	4/2001	Dickson	.....	D20/5
D571,141 S *	6/2008	Roosmalen et al.	.....	D7/307

**1 Claim, 7 Drawing Sheets**

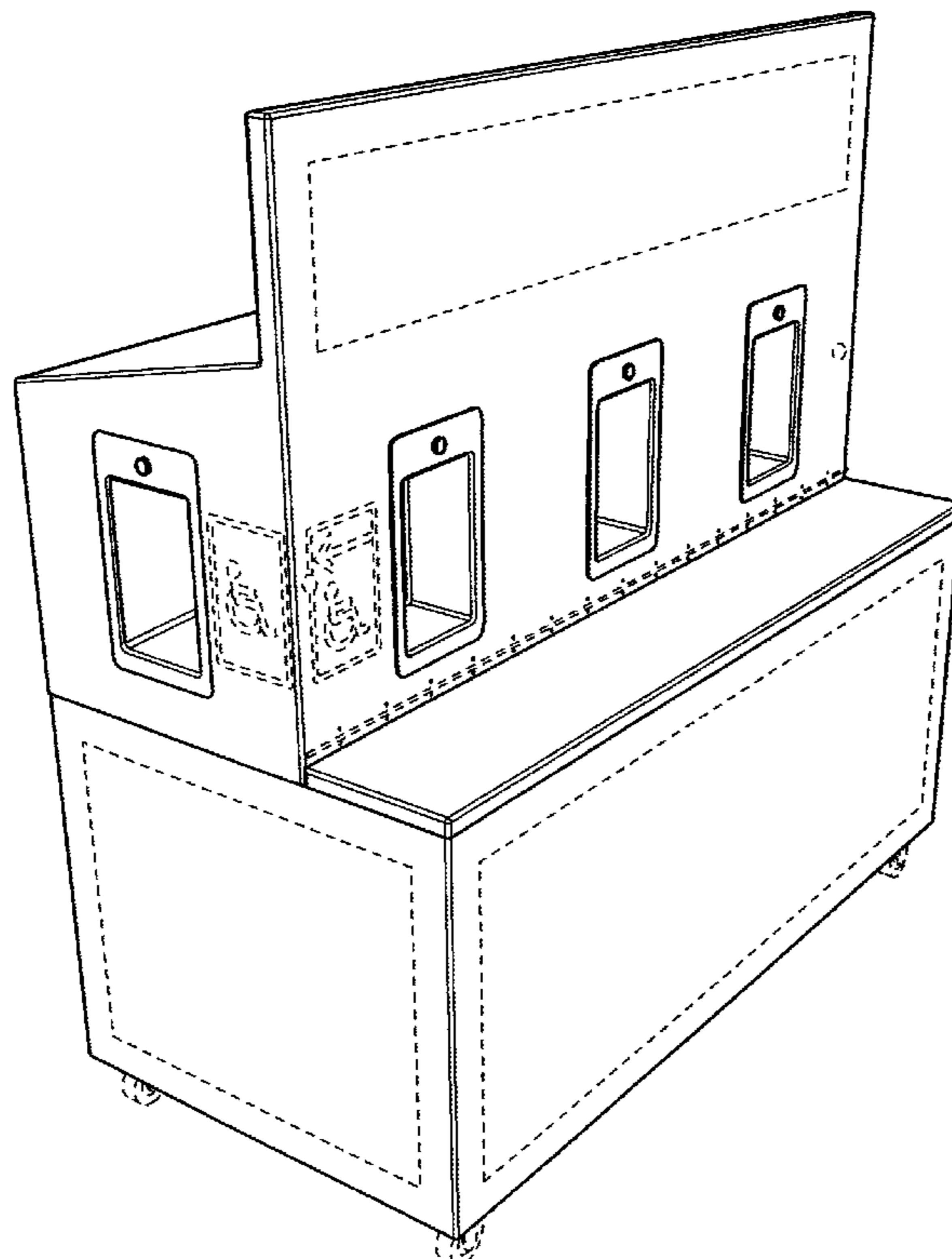

FIG. 1

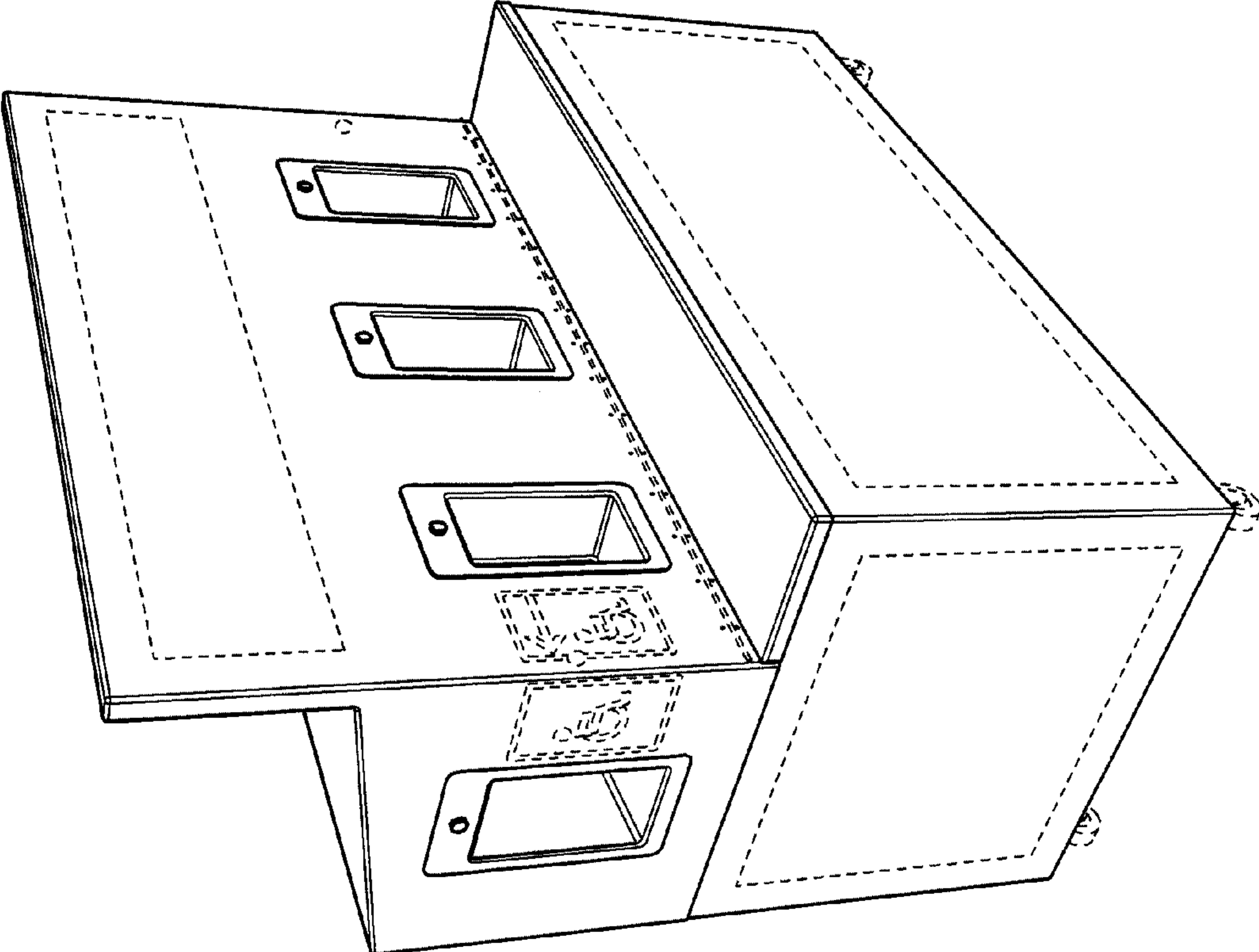
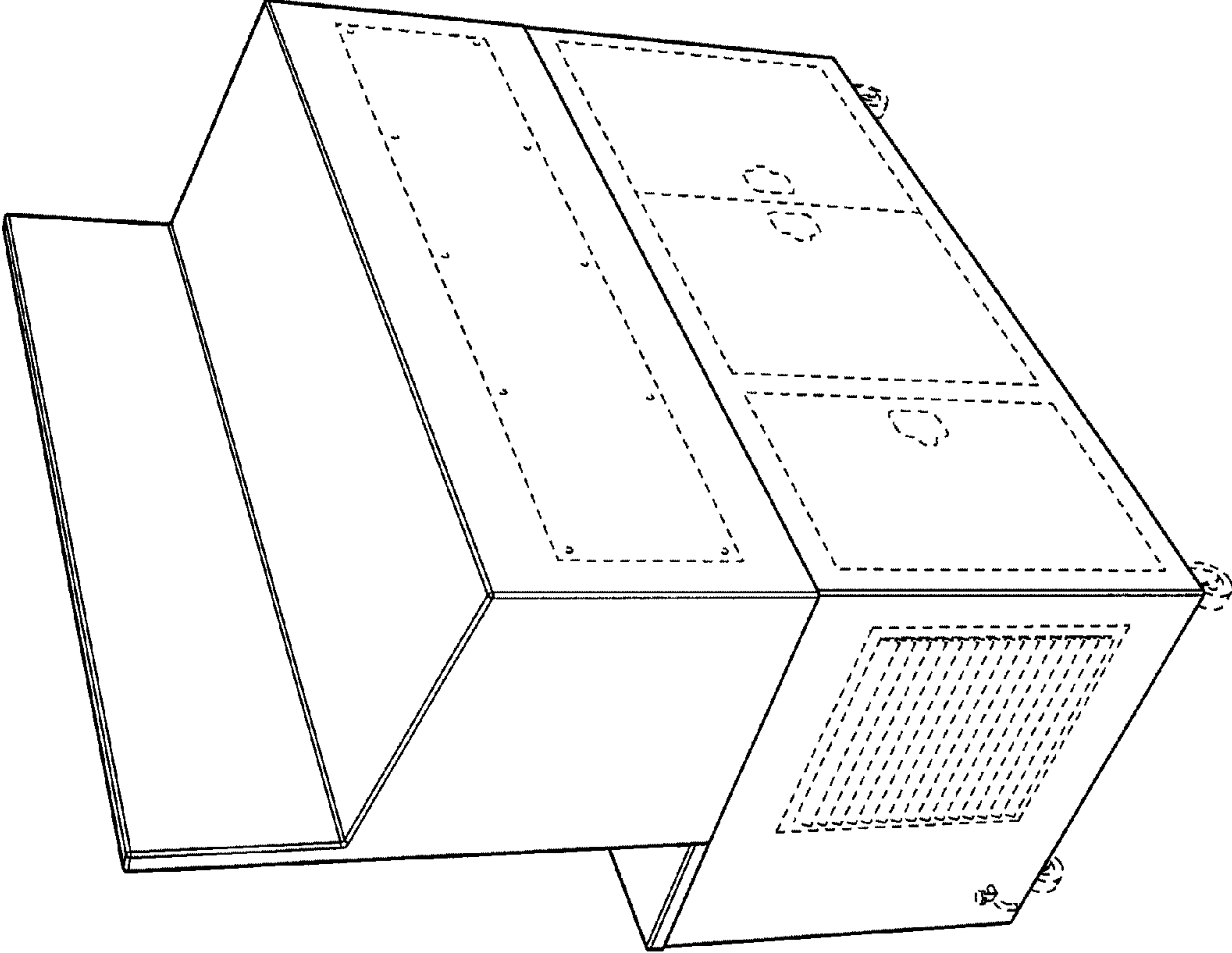

FIG. 2



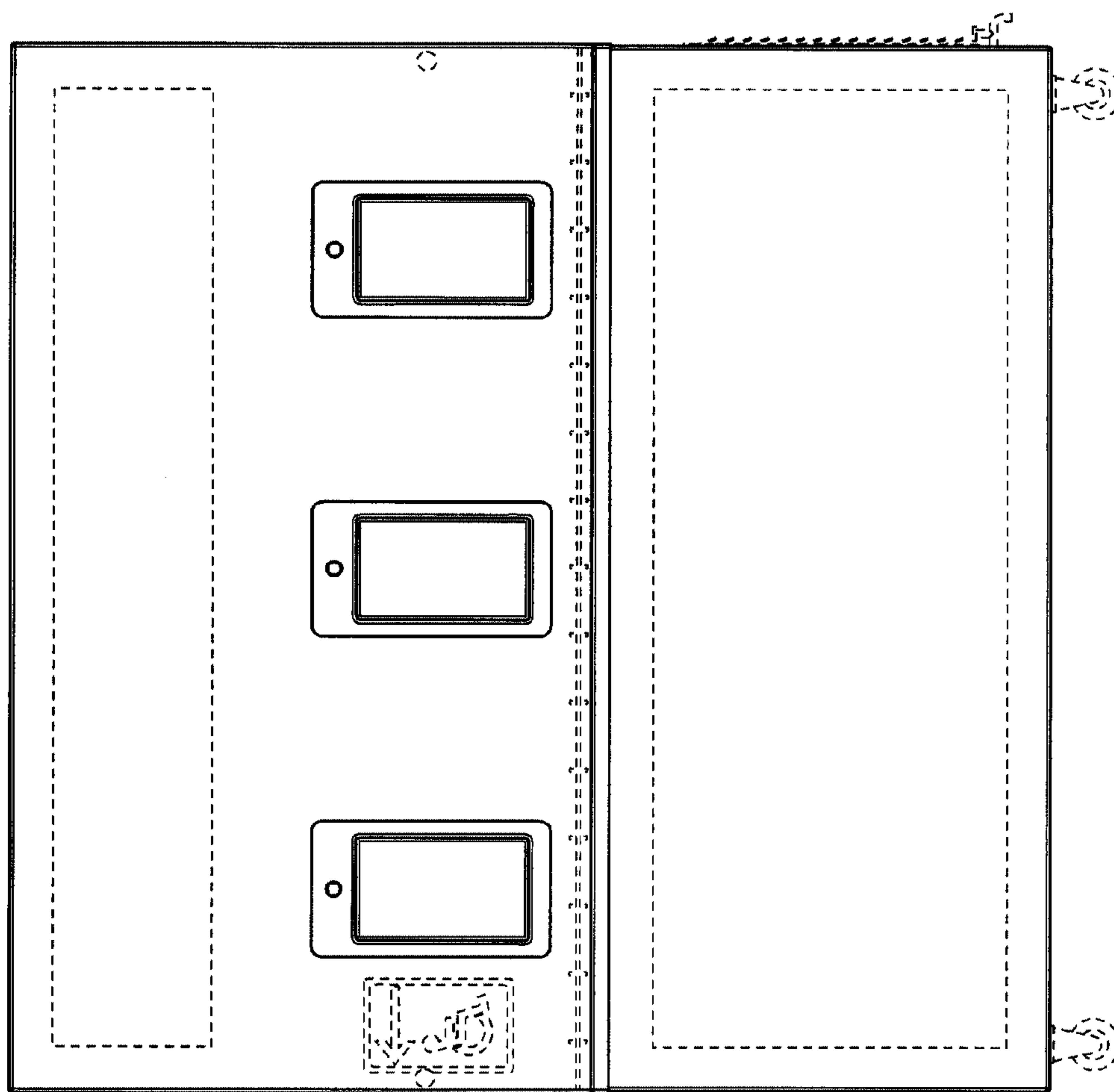

FIG. 3

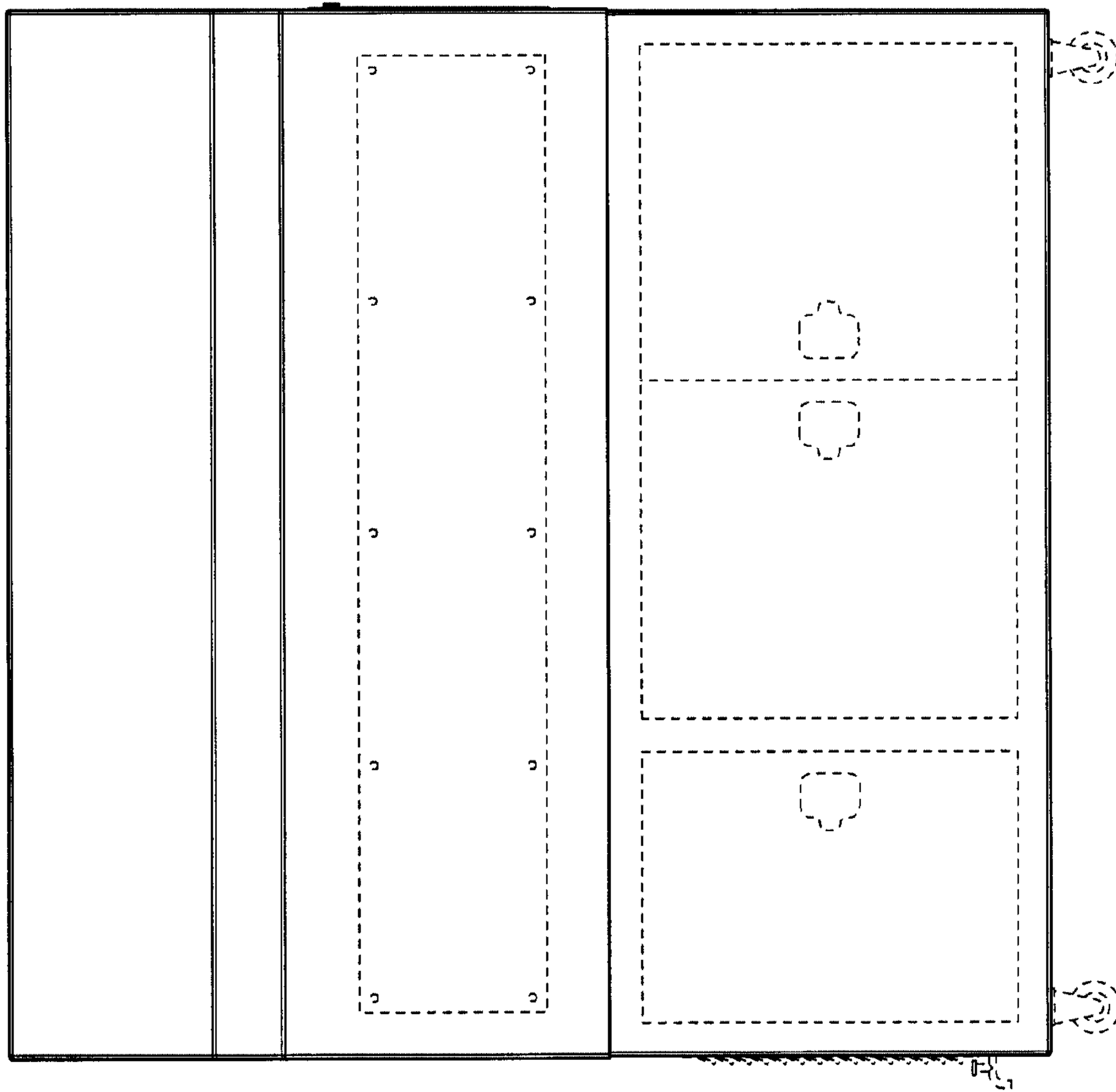

FIG. 4

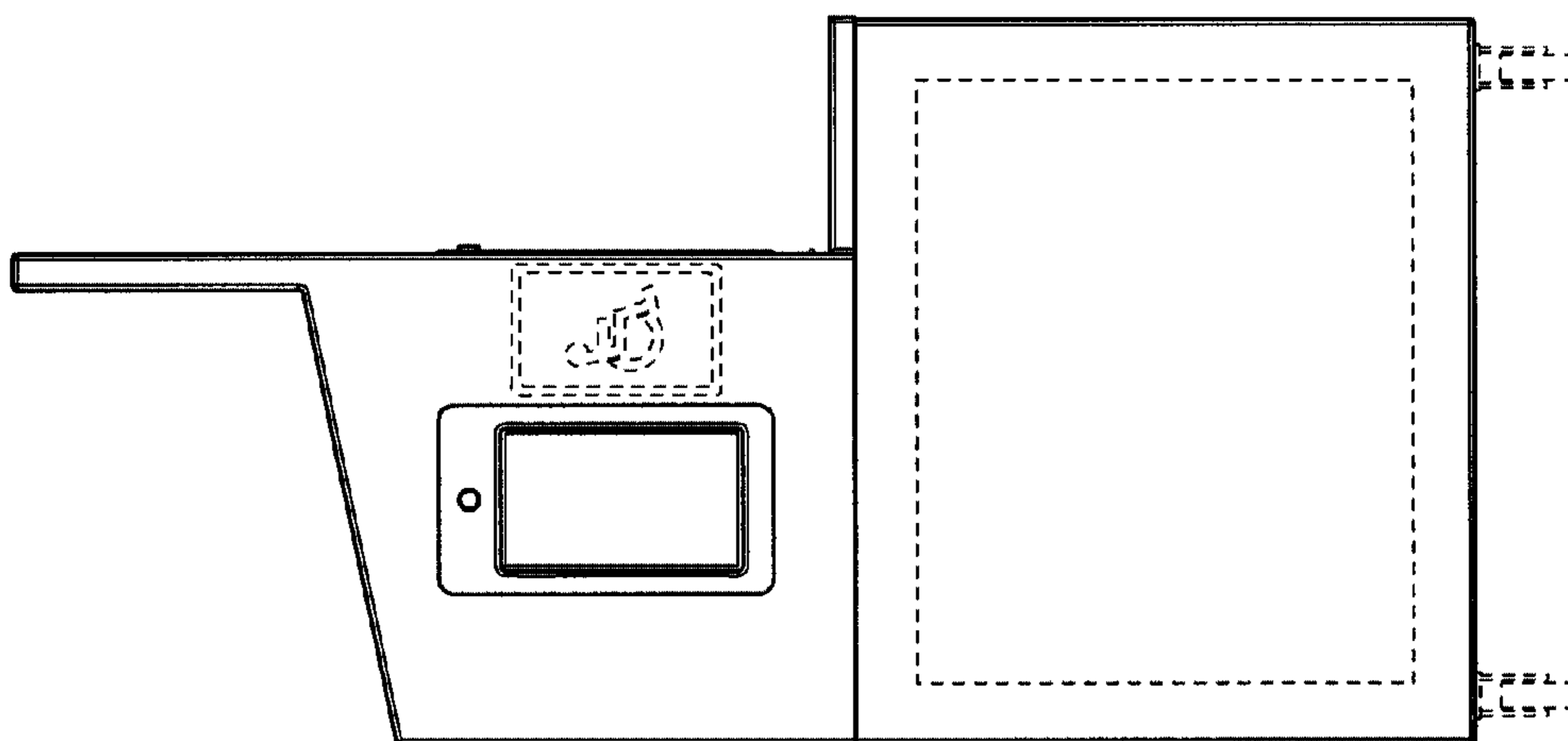

FIG. 6

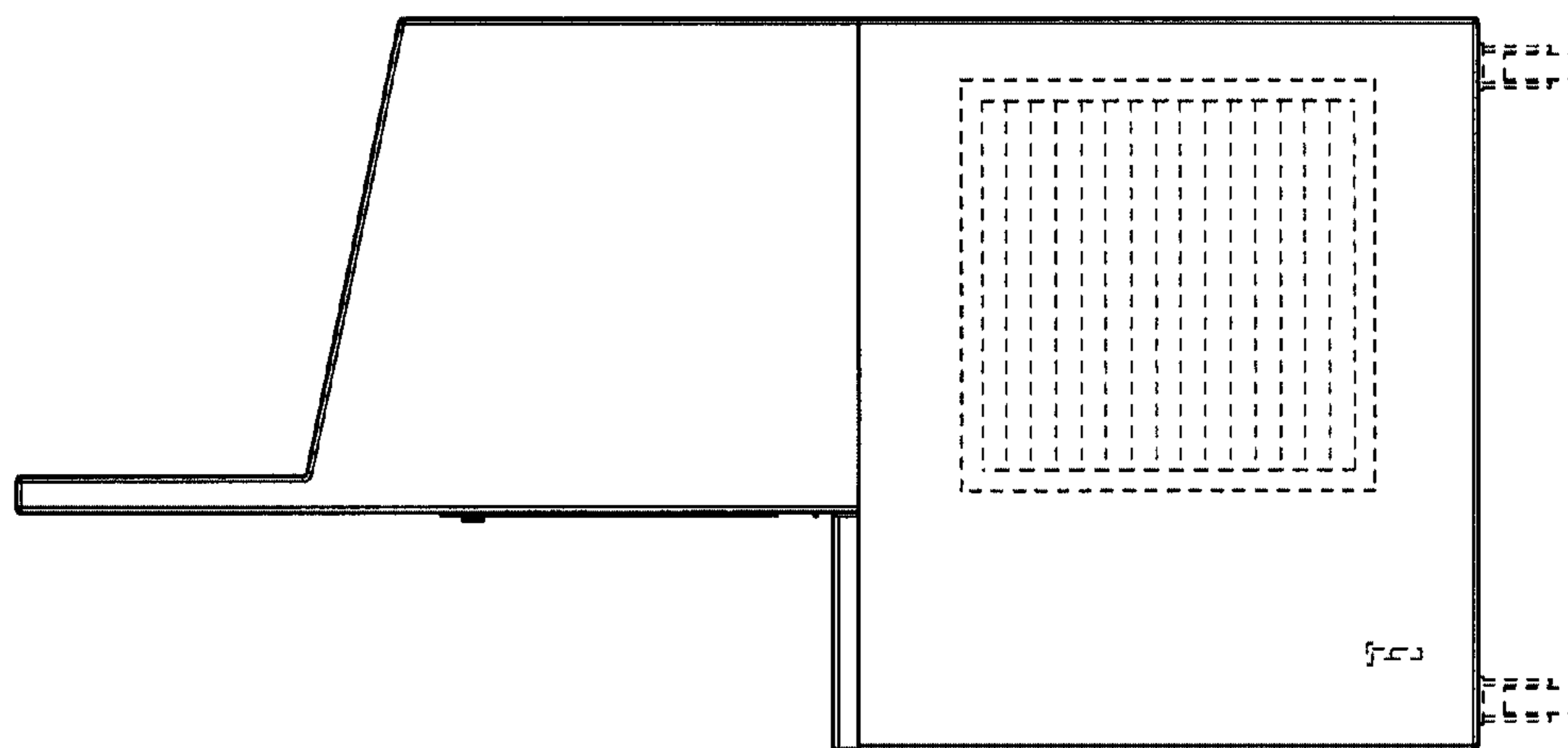
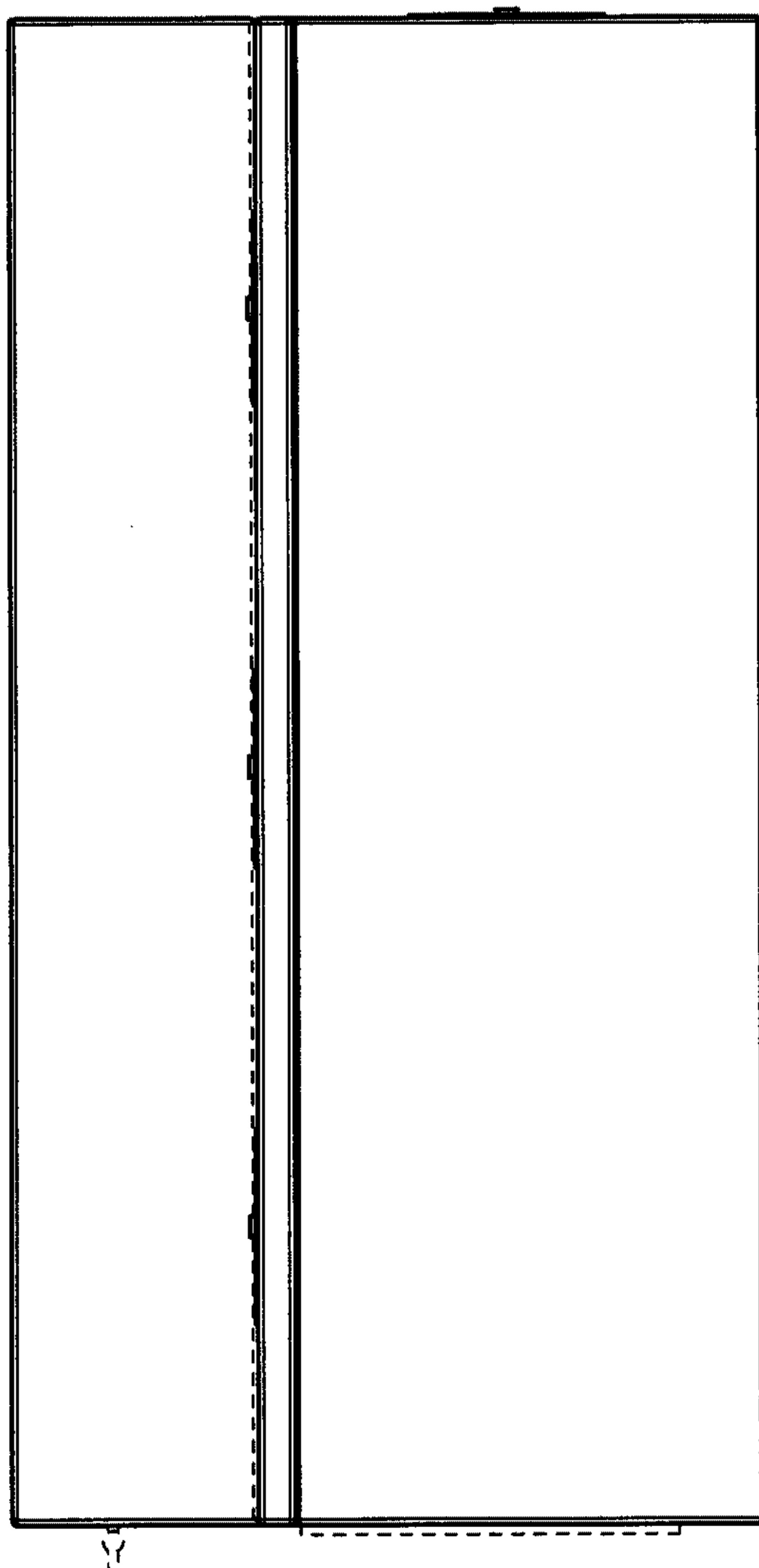

FIG. 5

FIG. 7



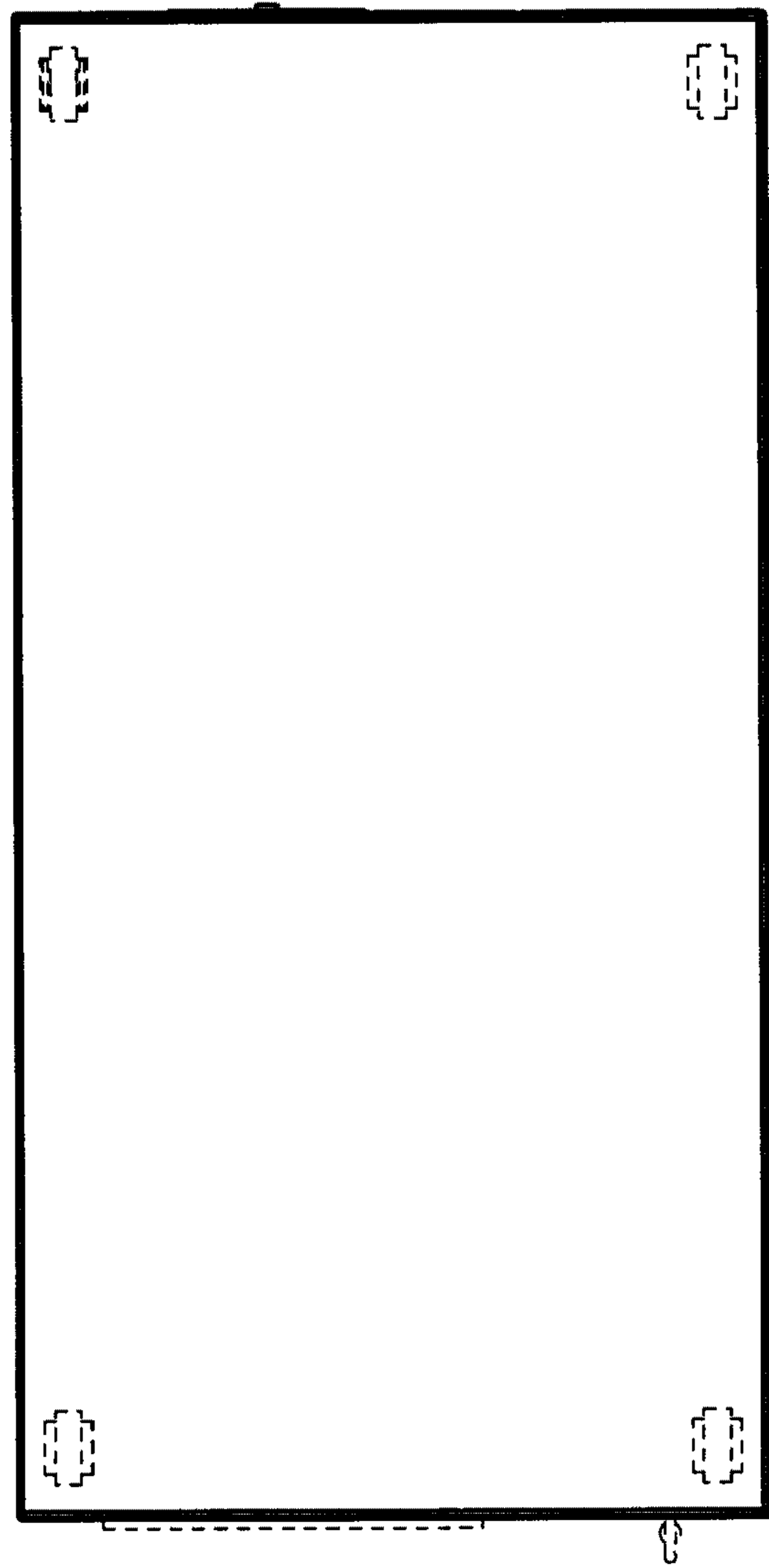

FIG. 8