



US00D651140S

(12) **United States Design Patent**  
**Greger et al.**

(10) **Patent No.:** **US D651,140 S**

(45) **Date of Patent:** **\*\* Dec. 27, 2011**

(54) **STROLLER FRAME TUBING**  
(75) Inventors: **Jeff G. Greger**, Lititz, PA (US); **Michael L. Longenecker**, Lancaster, PA (US)  
(73) Assignee: **Artsana USA, Inc.**, Lancaster, PA (US)

4,232,897 A 11/1980 Maclaren et al.  
4,248,443 A 2/1981 Ohlson  
4,317,581 A 3/1982 Kassai  
4,322,093 A 3/1982 Otto  
4,335,900 A 6/1982 Fleischer  
4,362,315 A 12/1982 Kassai  
4,365,819 A 12/1982 Bart

(Continued)

(\*\*) Term: **14 Years**

(21) Appl. No.: **29/381,489**

(22) Filed: **Dec. 20, 2010**

(51) **LOC (9) Cl.** ..... **12-12**

(52) **U.S. Cl.** ..... **D12/133**

(58) **Field of Classification Search** ..... D12/128-133;  
280/62, 647-650, 29, 200, 47.38, 250.1,  
280/259, 642, 658; 296/65.03, 65.04; 224/409;  
297/DIG. 4

See application file for complete search history.

FOREIGN PATENT DOCUMENTS

BE 818905 12/1974

(Continued)

OTHER PUBLICATIONS

Evenflo® Easy Comfort Premier™ Stroller (1999).

(Continued)

*Primary Examiner* — Ian Simmons

*Assistant Examiner* — Charles Hanson

(74) *Attorney, Agent, or Firm* — Volpe and Koenig, P.C.

(56) **References Cited**

U.S. PATENT DOCUMENTS

1,598,778 A 5/1923 Leake  
1,709,527 A 4/1929 Ford  
2,616,719 A 11/1952 Heideman  
2,783,053 A 2/1957 Sheldrick et al.  
3,112,042 A 11/1963 Leshner  
3,168,330 A 2/1965 Smith et al.  
3,227,484 A 1/1966 Merclean  
3,390,893 A 7/1968 MacLaren  
3,459,435 A 8/1969 Garner  
3,504,926 A 4/1970 Glaser  
3,556,546 A 1/1971 Garner  
3,561,787 A 2/1971 Toda et al.  
3,653,681 A 4/1972 Virtue  
3,799,567 A 3/1974 Toda  
3,989,295 A 11/1976 Sparkes  
4,007,947 A 2/1977 Perego  
4,023,825 A 5/1977 Kassai  
4,046,401 A 9/1977 Kassai  
4,111,454 A 9/1978 Kassai  
4,126,331 A 11/1978 Sloan et al.  
4,191,397 A 3/1980 Kassai

(57) **CLAIM**

The ornamental design for stroller frame tubing, as shown and described.

**DESCRIPTION**

FIG. 1 is a perspective view of a stroller frame tubing, showing our new design;  
FIG. 2 is a perspective view of the fragmentary section taken from lines 2-2 in FIG. 1;  
FIG. 3 is front elevation view thereof;  
FIG. 4 is a left side elevation view thereof;  
FIG. 5 is a right side elevation view thereof;  
FIG. 6 is a rear elevation view thereof;  
FIG. 7 is a top plan view thereof; and,  
FIG. 8 is a bottom plan view thereof.  
The broken lines illustrated environmental structure and form no part of the claimed design.

**1 Claim, 7 Drawing Sheets**

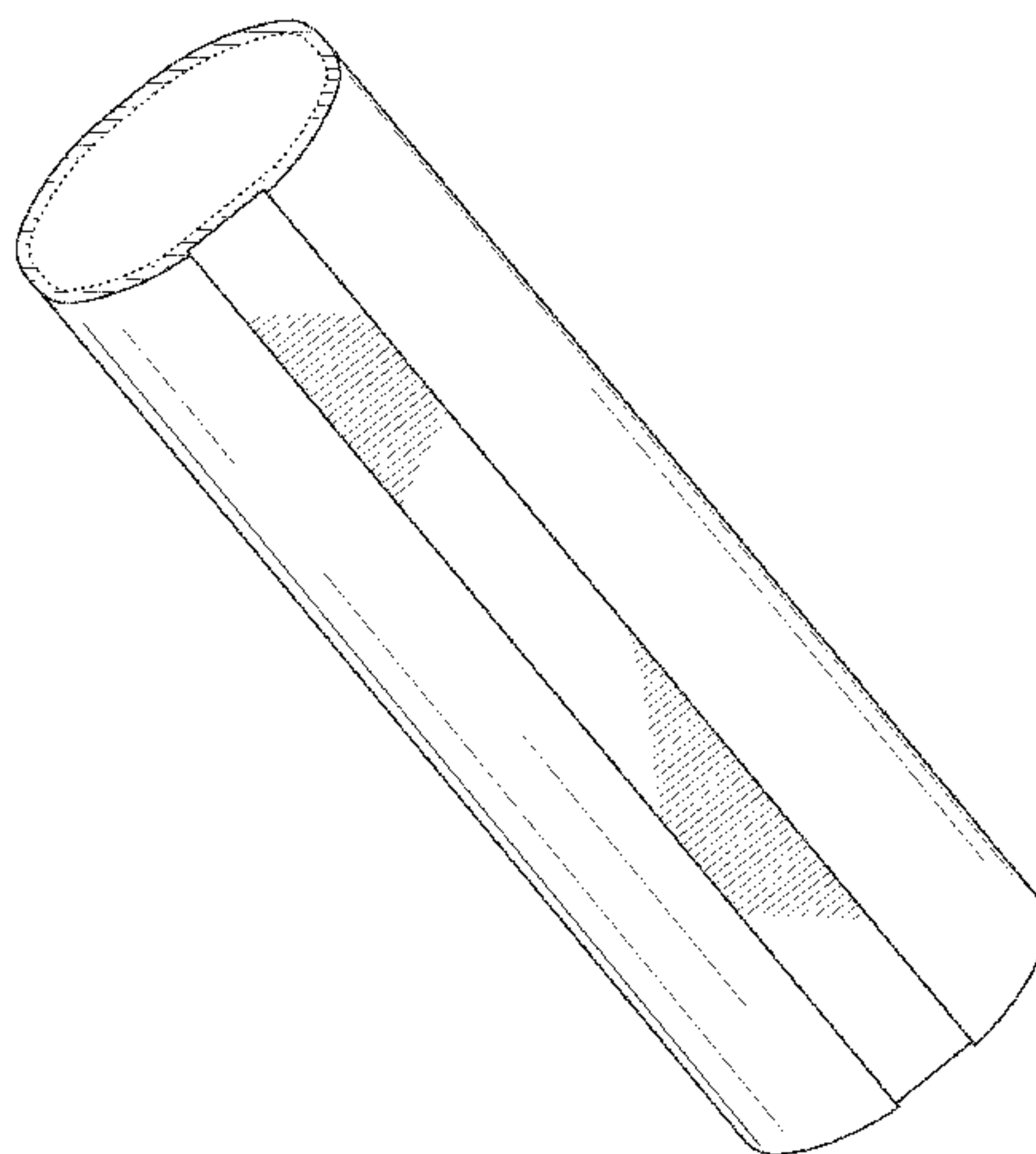

# US D651,140 S

U.S. PATENT DOCUMENTS					
4,378,946 A	4/1983	Voytko et al.	5,622,377 A	4/1997	Shamie
4,412,688 A	11/1983	Giordani	5,645,293 A	7/1997	Cheng
4,415,180 A	11/1983	Payne, Jr.	5,649,737 A	7/1997	Behnke
4,513,974 A	4/1985	Lin	5,664,795 A	9/1997	Haung
4,542,915 A	9/1985	Wheeler, III et al.	5,669,623 A	9/1997	Onishi
4,564,212 A	1/1986	Orlandino et al.	5,669,624 A	9/1997	Eichhorn
4,591,176 A	5/1986	Kassai	5,669,625 A	9/1997	Cabagnero
4,602,395 A	7/1986	Kassai	5,676,386 A	10/1997	Huang
4,606,550 A	8/1986	Cone	5,718,444 A	2/1998	Huang
4,610,460 A	9/1986	Kassai	5,722,682 A	3/1998	Wang
4,632,420 A	12/1986	Miyagi	5,727,798 A	3/1998	Walters et al.
4,632,421 A	12/1986	Shamie	5,741,021 A	4/1998	Saint et al.
4,660,850 A	4/1987	Nakao et al.	5,752,738 A	5/1998	Onishi et al.
4,706,986 A	11/1987	Kassai	5,765,855 A	6/1998	Chiu
4,733,882 A	3/1988	Kassai	5,765,856 A	6/1998	Kiser
4,741,056 A	5/1988	Kassai	5,769,447 A	6/1998	Huang
4,741,551 A	5/1988	Perego	5,772,235 A	6/1998	Espenshade
4,763,911 A	8/1988	Gebhard et al.	5,775,718 A	7/1998	Huang
4,763,919 A	8/1988	Nakao et al.	5,795,091 A	8/1998	Kakuda et al.
4,768,795 A	9/1988	Mar	5,810,432 A	9/1998	Haut et al.
4,770,437 A	9/1988	Glaser	5,845,666 A	12/1998	Messner
4,805,928 A	2/1989	Nakao et al.	5,845,924 A	12/1998	Huang
4,807,928 A	2/1989	Cone	5,876,057 A	3/1999	Huang
4,817,982 A	4/1989	Kassai	5,887,935 A	3/1999	Sack
4,819,958 A	4/1989	Perego	D412,142 S *	7/1999	Dickie ..... D12/133
4,832,361 A	5/1989	Nakao et al.	5,921,571 A	7/1999	Bell
4,856,809 A	8/1989	Kohus et al.	5,934,757 A	8/1999	Smith
4,886,289 A	12/1989	Yee et al.	5,938,229 A	8/1999	Chen et al.
4,892,327 A	1/1990	Cabagnero	5,947,555 A	9/1999	Welsh, Jr. et al.
4,906,017 A	3/1990	Kassai	D415,075 S *	10/1999	Lan ..... D12/133
4,907,818 A	3/1990	Chai	5,979,928 A	11/1999	Kuo
4,924,725 A	5/1990	Takahashi et al.	5,984,332 A *	11/1999	Beaudoin et al. .... 280/204
D308,656 S	6/1990	Takahashi et al.	5,988,669 A	11/1999	Freese et al.
4,930,697 A	6/1990	Takahashi et al.	5,988,670 A	11/1999	Song et al.
D310,645 S	9/1990	Julien	D419,113 S	1/2000	Everett
4,953,887 A	9/1990	Takahashi et al.	D421,940 S	3/2000	Gibson et al.
4,968,092 A	11/1990	Giambrone	6,068,284 A	5/2000	Kakuda
D317,280 S	6/1991	Takahashi et al.	6,070,890 A	6/2000	Haut et al.
5,028,061 A	7/1991	Hawkes	D427,822 S	7/2000	Greger
D320,370 S	10/1991	Takahashi et al.	6,099,022 A	8/2000	Pring
5,056,805 A	10/1991	Wang	6,102,431 A	8/2000	Sutherland et al.
5,074,575 A	12/1991	Bigo	D431,212 S	9/2000	Haung
5,087,066 A	2/1992	Mong-Hsing	D431,213 S	9/2000	Yang
5,110,150 A	5/1992	Chen	6,116,624 A	9/2000	Hu
5,143,398 A	9/1992	Teng	6,129,373 A	10/2000	Cheng
5,181,735 A	1/1993	Onishi	6,139,046 A	10/2000	Aalund et al.
5,184,835 A	2/1993	Huang	6,152,476 A	11/2000	Huang
5,201,535 A	4/1993	Kato et al.	6,155,740 A	12/2000	Hartenstine
5,205,577 A	4/1993	Liu	6,189,914 B1	2/2001	Worth et al.
5,205,579 A	4/1993	Kato et al.	6,193,263 B1	2/2001	Lin
D337,257 S *	7/1993	Danieli ..... D8/376	6,209,829 B1	4/2001	Yu
5,238,292 A	8/1993	Golenz et al.	6,273,451 B1	8/2001	Julien et al.
5,244,228 A	9/1993	Chiu	6,286,844 B1	9/2001	Cone, II et al.
5,246,272 A	9/1993	Kato et al.	6,296,004 B1	10/2001	Gordon
5,257,799 A	11/1993	Cone et al.	6,299,194 B1	10/2001	Chen
D352,017 S	11/1994	Kaneko	6,302,613 B1	10/2001	Lan
5,362,089 A	11/1994	Jyan-Tsai	D452,192 S	12/2001	Hartenstine et al.
5,388,852 A	2/1995	Bigo et al.	6,339,862 B1	1/2002	Cheng
5,398,951 A	3/1995	Ryu	6,368,006 B1	4/2002	Yang et al.
D357,439 S	4/1995	Haut et al.	6,398,233 B1	6/2002	Liang et al.
D357,440 S	4/1995	Pietra	6,409,205 B1	6/2002	Bapst et al.
5,417,449 A	5/1995	Shamie	6,412,809 B1	7/2002	Bigo et al.
5,417,450 A	5/1995	Wang	6,443,261 B1	9/2002	Gibson et al.
5,427,402 A	6/1995	Huang	6,443,479 B2	9/2002	Huang
5,431,478 A	7/1995	Noonan	6,446,990 B1	9/2002	Nania et al.
5,437,493 A	8/1995	Weisleder	6,467,739 B1	10/2002	Jou
5,441,163 A	8/1995	Carrasco	6,478,327 B1	11/2002	Hartenstine et al.
5,454,584 A	10/1995	Haut et al.	D470,803 S	2/2003	Hansen
5,460,395 A	10/1995	Chen	D473,663 S *	4/2003	Chou ..... D25/122
5,460,398 A	10/1995	Huang	6,557,871 B2	5/2003	Hsia
5,472,224 A	12/1995	Cabagnero	6,557,885 B1	5/2003	Kakuda
5,478,102 A	12/1995	Haung	6,572,134 B2	6/2003	Barrett et al.
5,489,138 A	2/1996	Mariol et al.	6,581,957 B1	6/2003	Lan
5,511,259 A	4/1996	Tarara	D480,195 S *	9/2003	Koerlin et al. .... D34/27
5,511,441 A	4/1996	Arai	6,666,473 B2	12/2003	Hartenstine et al.
5,524,503 A	6/1996	Ishikura	D494,511 S	8/2004	Chen
5,527,090 A	6/1996	Cone, II	6,851,700 B2	2/2005	Yoshie et al.
5,605,409 A	2/1997	Haut et al.	7,017,921 B2	3/2006	Eros
			7,017,937 B2	3/2006	Williams



# US D651,140 S

7,032,922	B1	4/2006	Lan	EP	0 897 848	8/1998
D521,422	S	5/2006	Williams	EP	0 901 953	3/1999
7,044,497	B2	5/2006	Hartenstine et al.	EP	0 997 367	8/1999
7,185,909	B2	3/2007	Espenshade et al.	EP	0 994 004	4/2000
7,188,858	B2	3/2007	Hartenstine et al.	EP	1 153 817	11/2001
D545,074	S	6/2007	Loew et al.	EP	1 170 193	1/2002
7,280,732	B2	10/2007	Fox et al.	EP	1 160 145	12/2004
7,281,732	B2	10/2007	Fox et al.	EP	1 666 331	6/2006
D558,648	S *	1/2008	Feyler et al. .... D12/129	EP	1 591 339	12/2008
7,338,122	B2	3/2008	Hei et al.	ES	2 016 525	8/1989
D566,629	S	4/2008	Taylor	ES	2 069 458	9/1992
7,445,229	B2	11/2008	Dotsey et al.	FR	2 089 832	4/1971
7,445,230	B2	11/2008	Kassai et al.	FR	2 244 348	9/1973
D593,272	S *	5/2009	Hailston ..... D34/27	FR	2 267 918	4/1974
D604,151	S *	11/2009	Kollman et al. .... D8/376	FR	2 257 482	1/1975
7,621,431	B2	11/2009	Williams	FR	2 323 563	9/1975
7,686,322	B2	3/2010	Longenecker et al.	FR	2 667 512	10/1990
D617,255	S *	6/2010	Tezak et al. .... D12/400	FR	2 767 509	8/1998
D630,934	S *	1/2011	Kollman et al. .... D8/376	GB	0 690 115	5/1950
7,871,100	B2	1/2011	Chen et al.	GB	1 176 516	7/1967
D636,300	S *	4/2011	Greger et al. .... D12/133	GB	1 394 564	12/1973
2005/0012306	A1	1/2005	Lan	GB	1 510 312	9/1974
2005/0242549	A1	11/2005	Longenecker et al.	GB	1 561 594	10/1976
2006/0001226	A1	1/2006	Refsum	GB	2 124 556	6/1982
2006/0131840	A1	6/2006	Donay	GB	2 186 793	2/1987
2006/0131841	A1	6/2006	Huang	GB	2 197 784	6/1988
2006/0152059	A1	7/2006	Refsum	GB	2 225 557	12/1988
2006/0157945	A1	7/2006	Refsum	GB	2 244 029	3/1990
2006/0219374	A1	10/2006	McKinney	GB	2 268 394	5/1992
2006/0261576	A1	11/2006	Dotsey et al.	GB	2 251 830	7/1992
2009/0127827	A1	5/2009	Pike et al.	GB	2 318 099	10/1996
2009/0127828	A1	5/2009	Longenecker et al.	GB	2 324 510	3/1998
2009/0243260	A1	10/2009	Longenecker et al.	GB	2 342 897	10/1999
2010/0038886	A1	2/2010	Greger et al.	IT	1233953	1/1989
2010/0171289	A1	7/2010	Greger et al.	JP	10-35506	2/1989
				JP	10-35506	2/1998
				NL	1009312	6/1998
				PT	84257	2/1987
				SU	1156949	4/1983
				WO	88/02714	4/1988
				WO	93/07039	4/1993
				WO	99/50123	10/1999
				WO	00/06437	2/2000
				WO	01/28840	4/2001
				WO	2009/065129	5/2009

## FOREIGN PATENT DOCUMENTS

DE	34 07 241	2/1984
DE	35 25 834	7/1985
DE	38 30 752	9/1988
DE	40 22 391	7/1990
DE	42 29 857	9/1992
DE	195 43 273	11/1995
DE	196 15 901	4/1996
DE	196 38 097	9/1996
DE	198 33 857	7/1997
DE	198 33 115	7/1998
DE	299 00 901	1/1999
DE	200 01 964	4/2000
DE	200 02 027	4/2000
DE	203 11 781	10/2003
EP	0 422 812	10/1990
EP	0 639 489	8/1994
EP	0 719 693	11/1995

## OTHER PUBLICATIONS

Evenflo® Light & Easy™ Stroller (1999).  
 Evenflo® Easy Comfort Classic™ Travel System (1999).  
 Evenflo® Easy Comfort Plus™ Travel System (1999).  
 Evenflo® Easy Comfort Premier™ Travel System (1999).  
 Jane® Twin Two Stroller (printed May 5, 2010).

\* cited by examiner

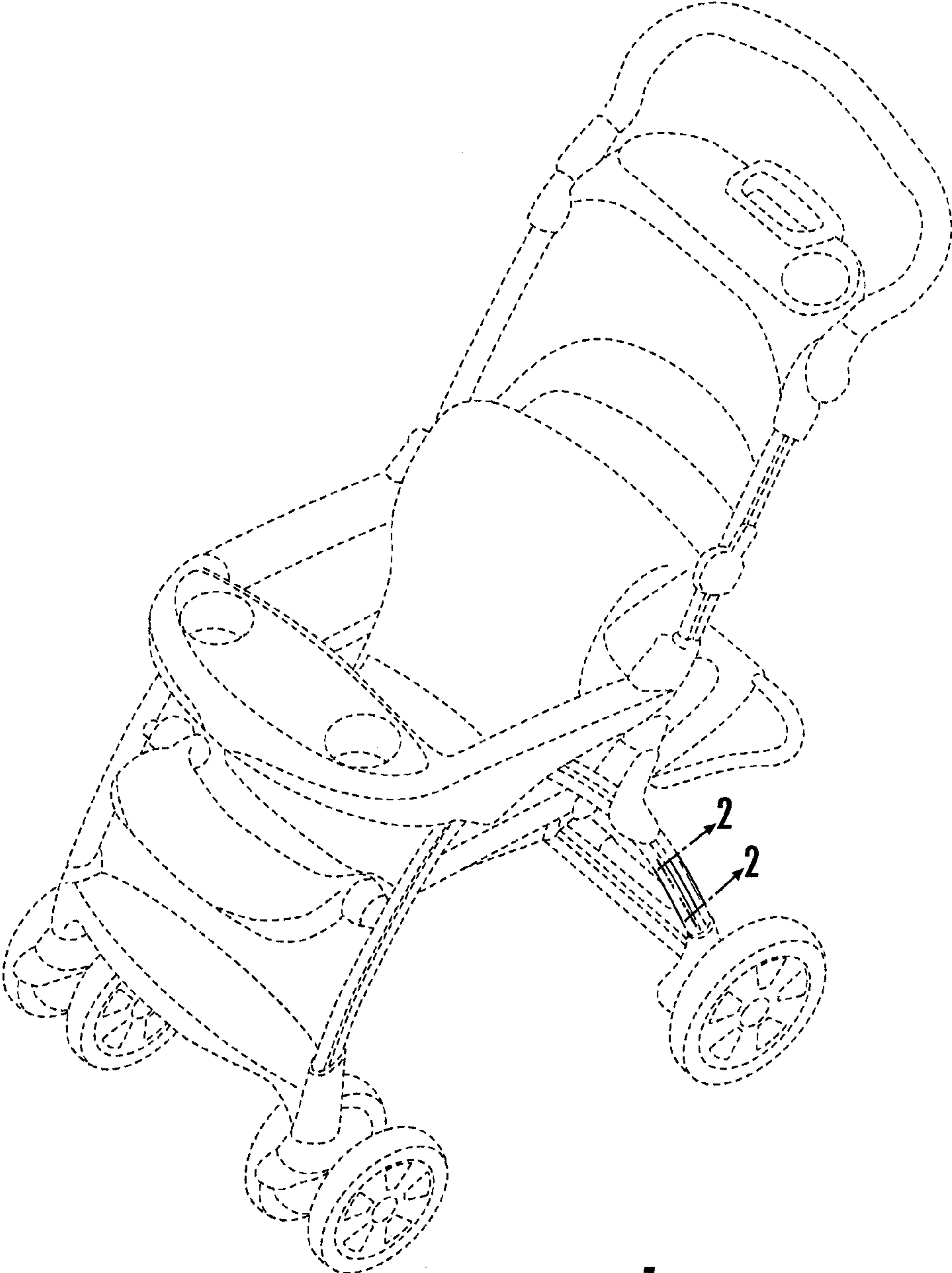
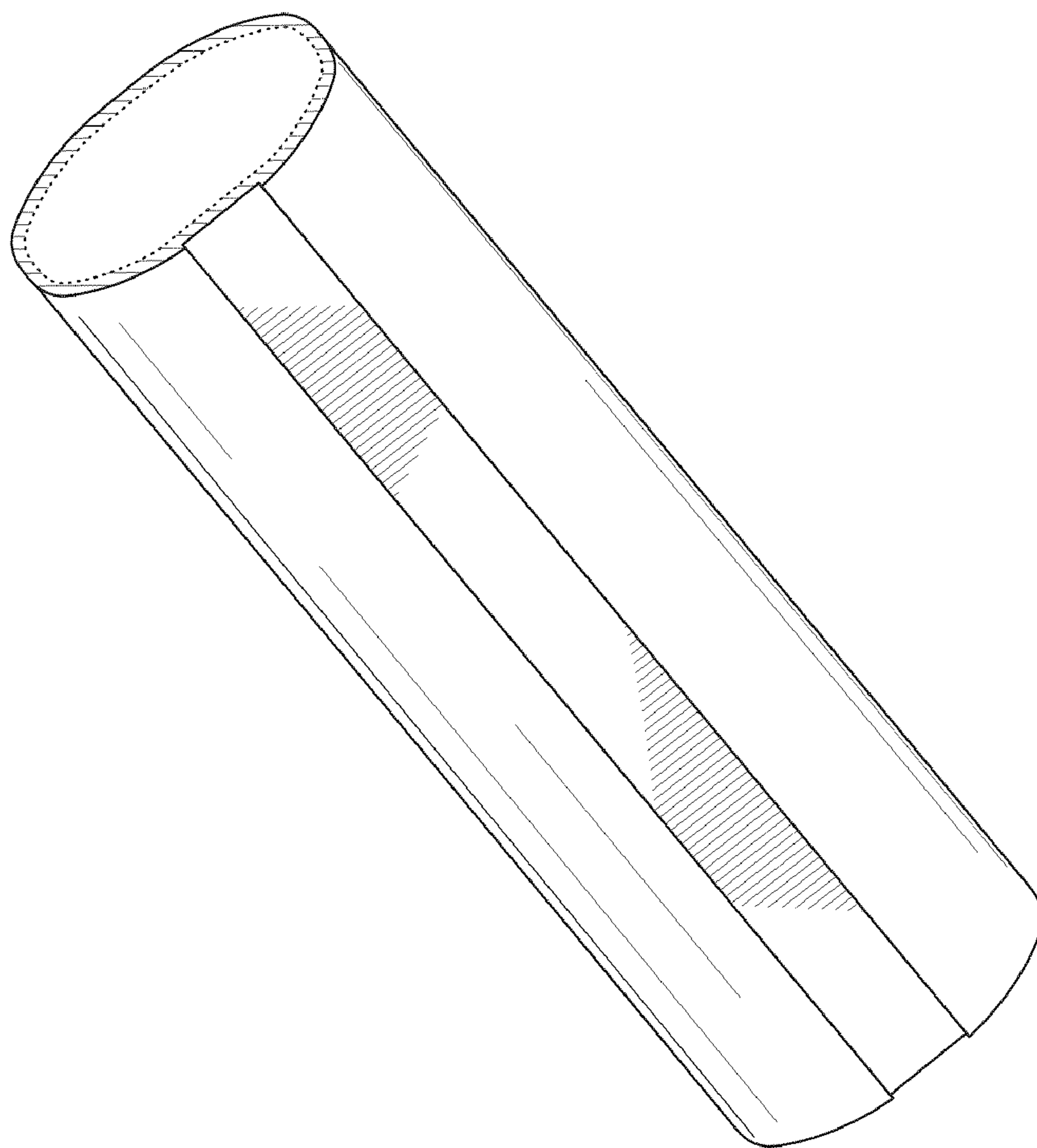

FIG. 1



**FIG. 2**

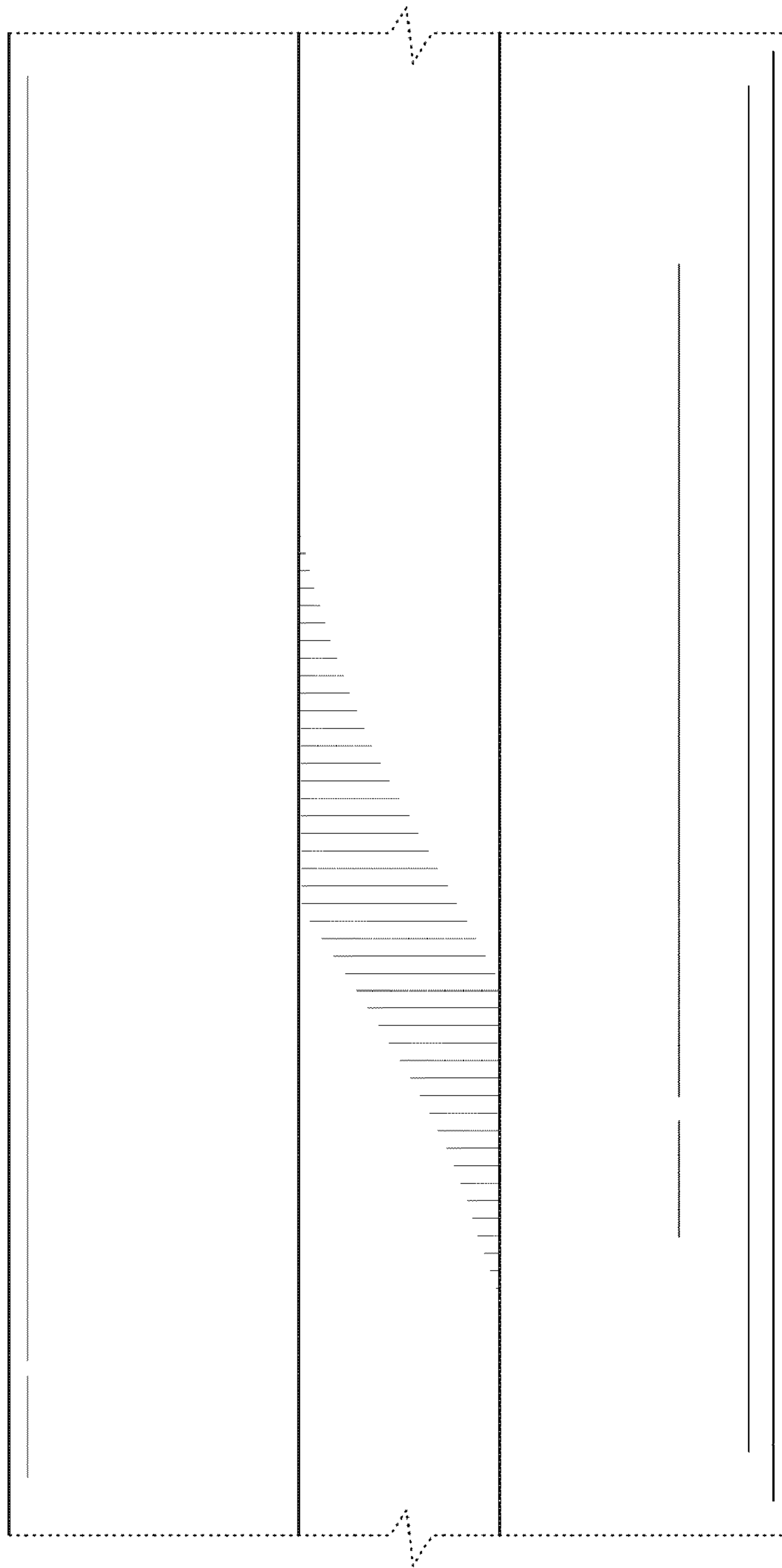
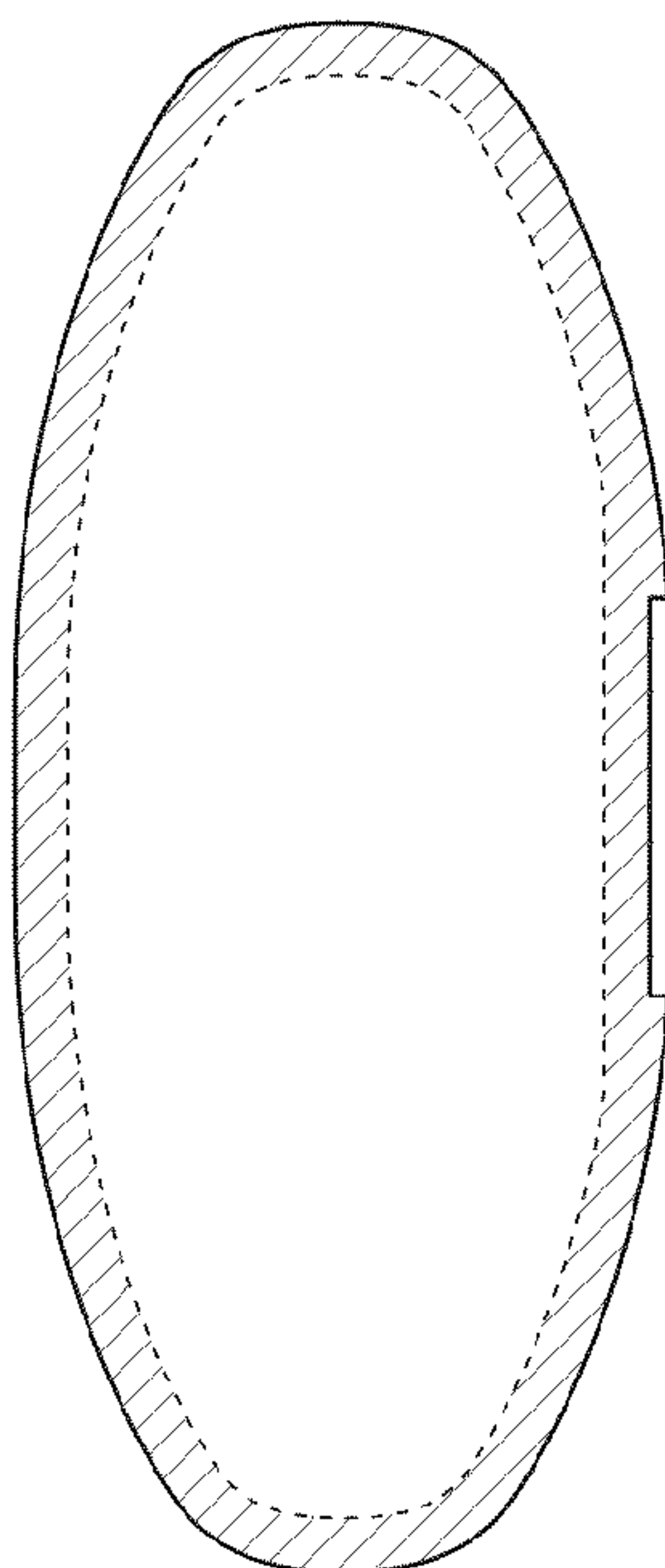
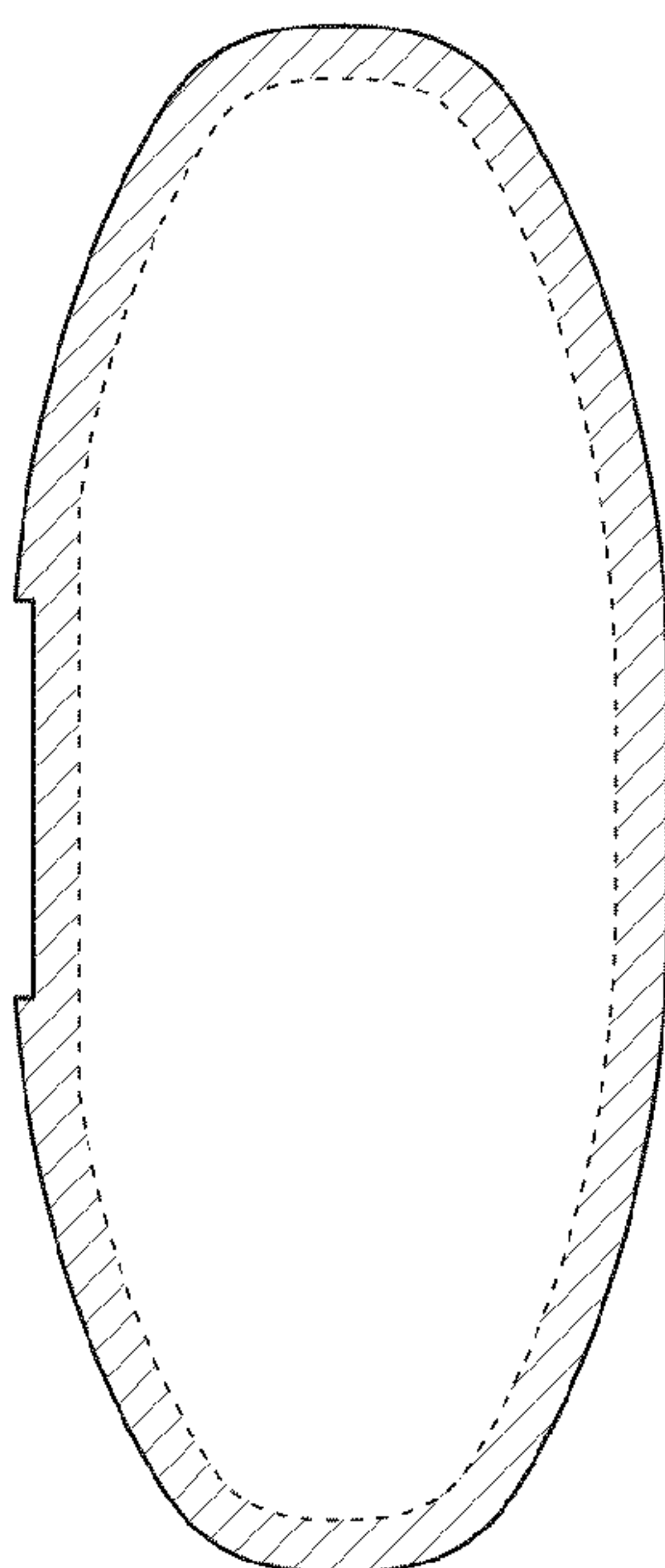

FIG. 3



**FIG. 4**



**FIG. 5**

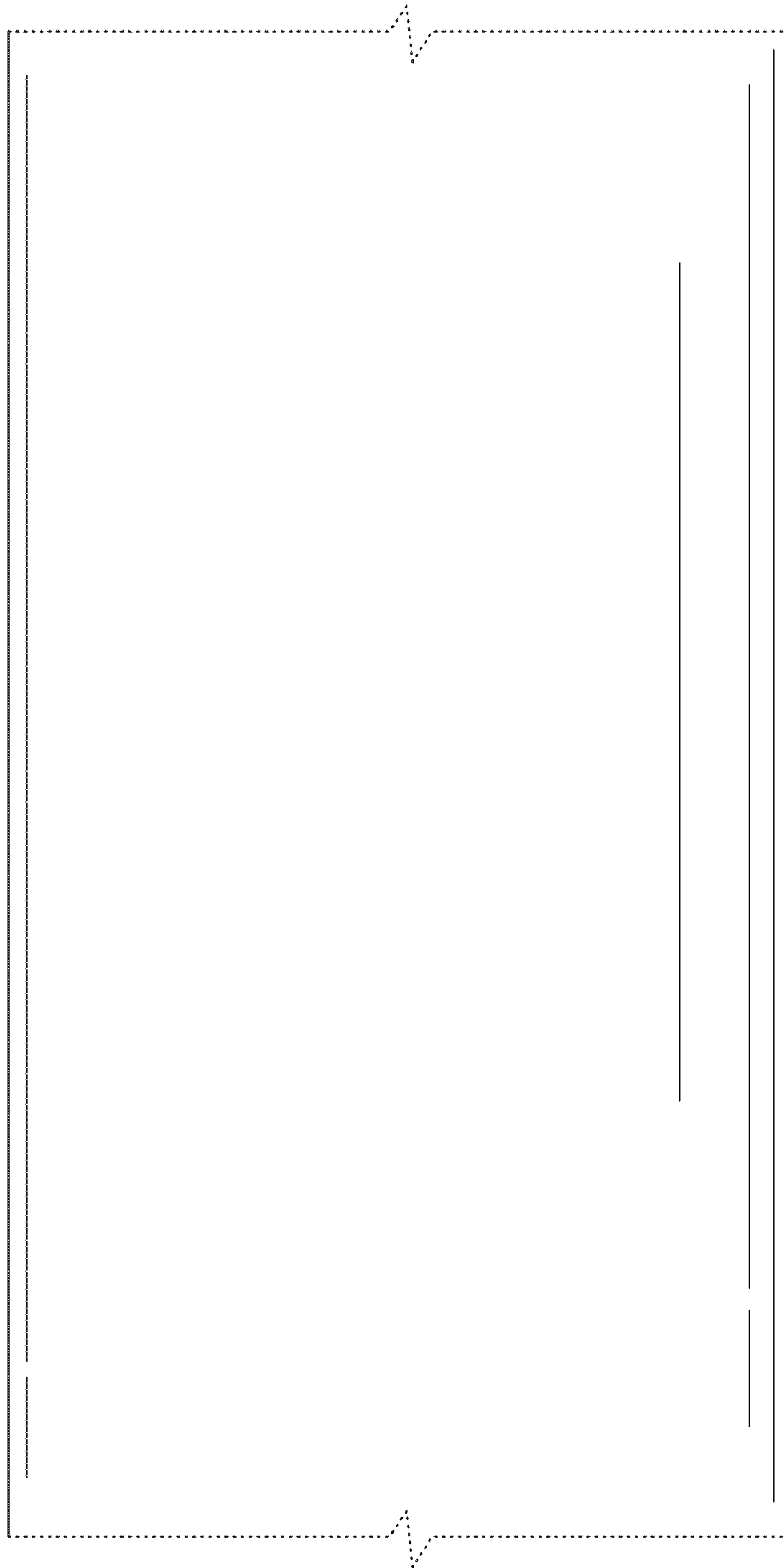
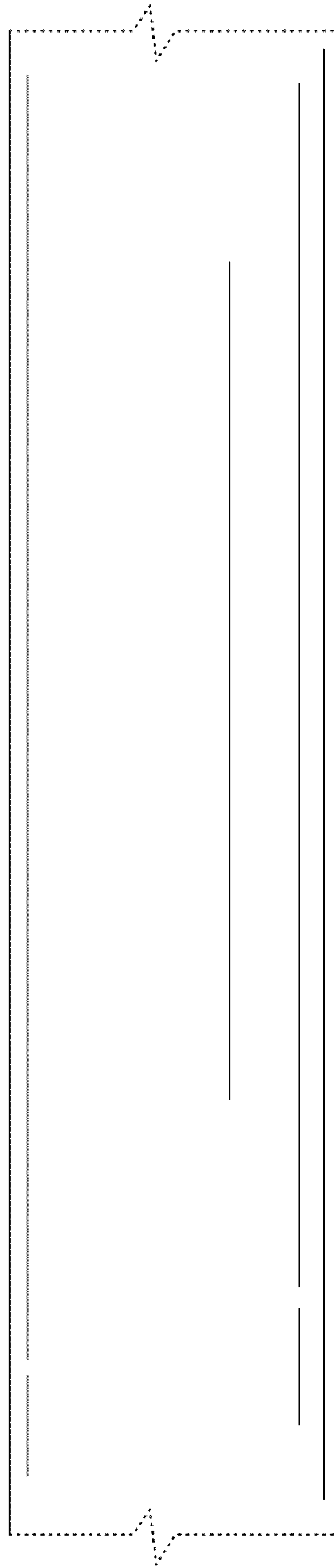

FIG. 6





**FIG. 7**

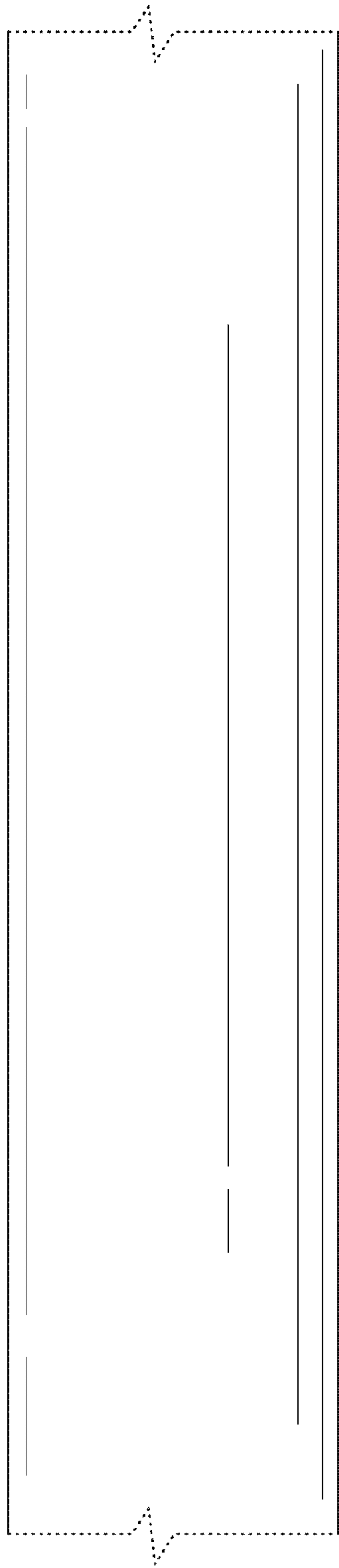

FIG. 8